

Monoblocchi a parete a propano



DESCRIZIONE GENERALE GAMMA

Unità precaricate di refrigerante

Dotate di compressori ermetici a pistoni funzionanti con refrigerante ecologico R290 (propano – GWP 3). Ogni circuito contiene una carica di propano inferiore a 150 grammi.

Ampio range di applicazione

Progettate per un ampio range di temperature esterne (Temperatura minima +10°C , temperatura massima +43°C). Unità dotata di pressostato ventola condensatore.

Set point cella impostabile da +5°C a -5°C per le unità TN e da -18°C a -25°C per le unità BT.

Facilità di installazione

Installazione accavallata con opzione a tampone per installazione attraverso la parete della cella. Resistenza di scarico inclusa con sistema automatico di evaporazione della condensa.

Soluzione "plug and play"

Monoblocco dotato di controllore elettronico, cavo predisposto per interruttore micro-porta, cavo predisposto per luce cella, cavo predisposto per resistenza porta (solo per modelli BT)



DATI TECNICI

Modello: NXR116

DATI GENERALI		
Compressore		16,80 cc
Tipo compressore		Ermetico
Tipo refrigerante		R290
Tipo sbrinamento		Gas caldo

DATI ELETTRICI		
Alimentazione	V/ph/Hz	230/1/50
Potenza max assorbita	W	986
Corrente max assorbita	A	4,86

CONDENSATORE		
Ventilatore	n. x Ø	1 x 254mm
Portata aria	m ³ /h	680
EVAPORATORE		
Ventilatore	n. x Ø	1 x 254mm
Portata aria	m ³ /h	630
Freccia aria	m	6

PESI e DIMENSIONI		
Dimensioni	Rif.	Forma 1
Peso netto	kg	45
Peso lordo	kg	75
Tipo imballo		Gabbia in legno

Resa in tabella

T ambiente	T cella		*
25°C	+5 °C	W	1679
		m ³	15,8
	0 °C	W	1477
		m ³	15,0
	-5 °C	W	1279
		m ³	9,2
32 °C	+5 °C	W	1555
		m ³	13,0
	0 °C	W	1370
		m ³	10,7
	-5 °C	W	1198
		m ³	7,9
43 °C	+5 °C	W	1360
		m ³	10,0
	0 °C	W	1228
		m ³	7,0
	-5 °C	W	1062
		m ³	6,2

*volumi suggeriti per celle con spessore isolamento 80mm e pavimento isolato

Installazione unità

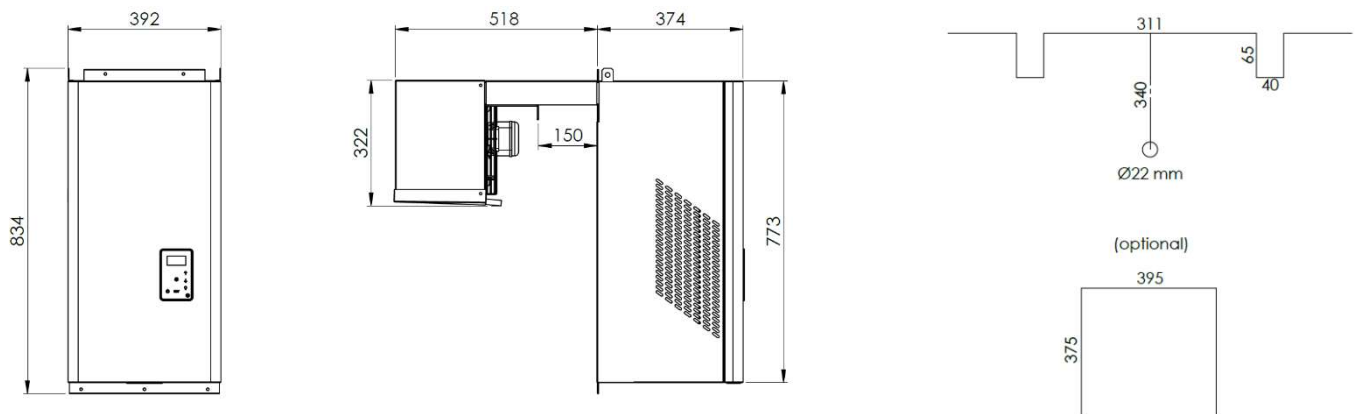

Ingombri trasporto unità

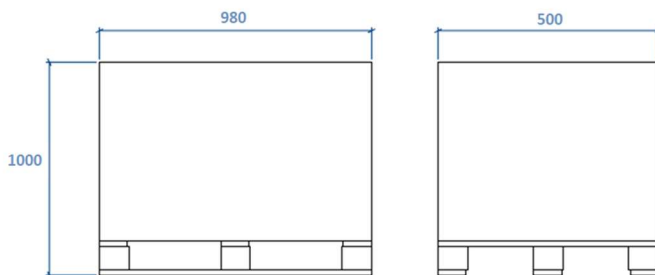

Optional

- Condensazione ad acqua (con valvola barostatica)
- Kit montaggio tampone
- Modulo WI-FI per monitoraggio remoto (industria 4.0)
- Protezione cataforesi batteria evaporatore e condensatore
- Voltaggio speciale (contattare Ufficio Tecnico)



Wall-mounted monobloc units with propane



General description

Pre-charged units

Equipped with hermetic reciprocating compressor working with R290 "green" refrigerant (propane – GWP 3). Each circuit includes less than 150 gr of propane.

Wide application range

Developed to work at wide external temperatures range (min temp +10°C , max temp +43°C). The unit includes a condenser fan pressure switch. Set point from +5°C to -5°C for MT units and set point from -18°C to -25°C for LT units.

Easy installation

Straddle mounted installation, additional option with panel kit to be installed through the wall. Equipped with the drain heater and automatic system to remove condensate water)

"Plug and play" solution

Equipped with the electronic controller, a pre-arranged door switch cable, a pre-arranged room light cable, a pre-arranged door heater cable (for LT units only)



TECHNICAL DATA

Model: NXR116

GENERAL DATA		
Compressor		16,80 cc
Compressor type		Hermetic
Refrigerant charge		R290
Defrost system		Hot gas

ELECTRICAL DATA		
Voltage	V/ph/Hz	230/1/50
Max power input	W	986
Max operating current	A	4,86

CONDENSER		
Fan	n. x Ø	1 x 254mm
Air flow rate	m ³ /h	680
EVAPORATOR		
Fan	n. x Ø	1 x 254mm
Air flow rate	m ³ /h	630
Air thrown	m	6

WEIGHT and DIMENSIONS		
Dimensions	Ref.	Fig. 1
Net Weight	kg	45
Gross Weight	kg	75
Packing		Wooden crate

Cooling capacity

Ext. Temp.	Room Temp.		*
25°C	+5 °C	W	1679
		m ³	15,8
	0 °C	W	1477
		m ³	15,0
	-5 °C	W	1279
		m ³	9,2
32 °C	+5 °C	W	1555
		m ³	13,0
	0 °C	W	1370
		m ³	10,7
	-5 °C	W	1198
		m ³	7,9
43 °C	+5 °C	W	1360
		m ³	10,0
	0 °C	W	1228
		m ³	7,0
	-5 °C	W	1062
		m ³	6,2

*Suggested m³ Volume for cold rooms with 80mm wall thickness and insulated floor

Installation

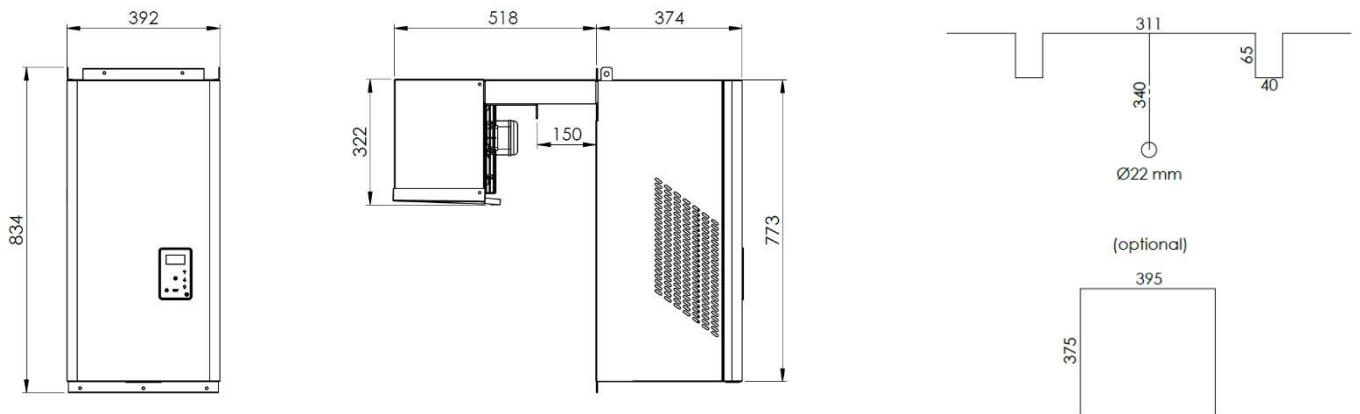

Shipment information

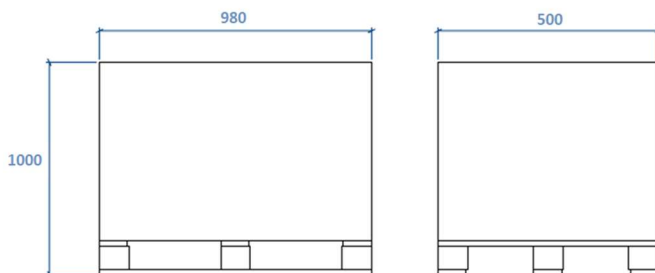

Additional Options

- Water-cooled condenser (with pressure valve)
- Panel kit (through the wall installation)
- WI-FI connection to a remote monitoring system
- Cataphoresis protection on condenser and evaporator coils
- Special voltage (please contact our Engineering department)



Groupes monobloc à parois avec propane



CHARACTERISTIQUES PRICIPALES DE LA GAMME

Unités préchargées en réfrigérant

Equipées avec compresseurs hermétiques à piston fonctionnant avec le réfrigérant écologique R290 (propane – GWP 3). Chaque circuit contient une charge de propane inférieure à 150 grammes.

Large gamme d'application

Conçu pour une large plage de températures extérieures (température minimale +10°C, température maximale +43°C). Unité équipée d'un pressostat du ventilateur du condenseur.

Point de consigne de la chambre réglable de +5°C à -5°C pour les unités TN et de -18°C à -25°C pour les unités BT.

Facilité d'installation

Installation à cheval avec option à tampon pour une installation à travers la paroi de la chambre froide. Résistance de décharge incluse avec système d'évaporation automatique des condensats.

Solution "plug and play"

Monobloc équipé de contrôleur électronique, câble prédisposé pour interrupteur micro- porte, câble prédisposé pour éclairage de la chambre froide, câble prédisposé pour résistance de porte (uniquement pour les modèles BT).



DONNÉES TECHNIQUES

Model: NXR116

DONNÉES GENERALES		
Compresseur		16,80 cc
Type compresseur		Hermetique
Type de gaz		R290
Type de degivrage		Gaz chaud

DONNÉES ELECTRIQUES		
Tension	V/ph/Hz	230/1/50
Puissance max absorbée	W	986
Courant max absorbée	A	4,86

CONDENSEUR		
Ventilateur	n. x Ø	1 x 254mm
Débit d'air	m ³ /h	680
EVAPORATEUR		
Ventilateur	n. x Ø	1 x 254mm
Débit d'air	m ³ /h	630
Projection d'air	m	6

POIDS ET DIMENSIONS		
Dimensions	Rif.	Taille l
Poids net	kg	45
Poids gross	kg	75
Emballage		Claire voie

Puissances frigorifiques

T exterieure	T chambre		*
25°C	+5 °C	W	1679
		m ³	15,8
	0 °C	W	1477
		m ³	15,0
	-5 °C	W	1279
		m ³	9,2
32 °C	+5 °C	W	1555
		m ³	13,0
	0 °C	W	1370
		m ³	10,7
	-5 °C	W	1198
		m ³	7,9
43 °C	+5 °C	W	1360
		m ³	10,0
	0 °C	W	1228
		m ³	7,0
	-5 °C	W	1062
		m ³	6,2

*volumes suggérés pour épaisseur isolation chambre 80mm avec sol isolé



Installation unité

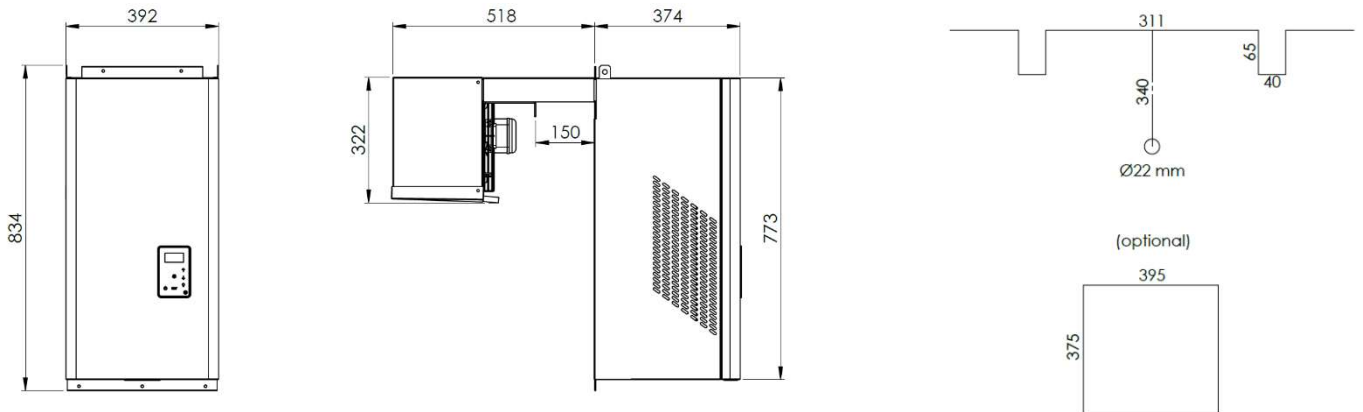

Dimensions de transport de l'unité

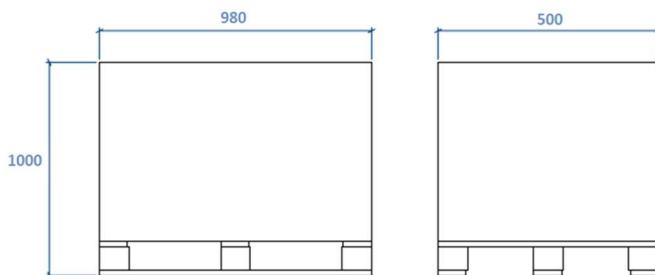

Options

- Condensation par eau (avec vanne barostatique)
- Kit installation tampon
- Module WI-FI de surveillance à distance (industrie 4.0)
- Protection phorèse sur la batterie condenseur et évaporateur
- Tension spéciale (contacter notre Bureau d'Etude)