

Operating instruction

Case Controller UA 400

Universal Controller for thermostatic expansion Valves (TEV)

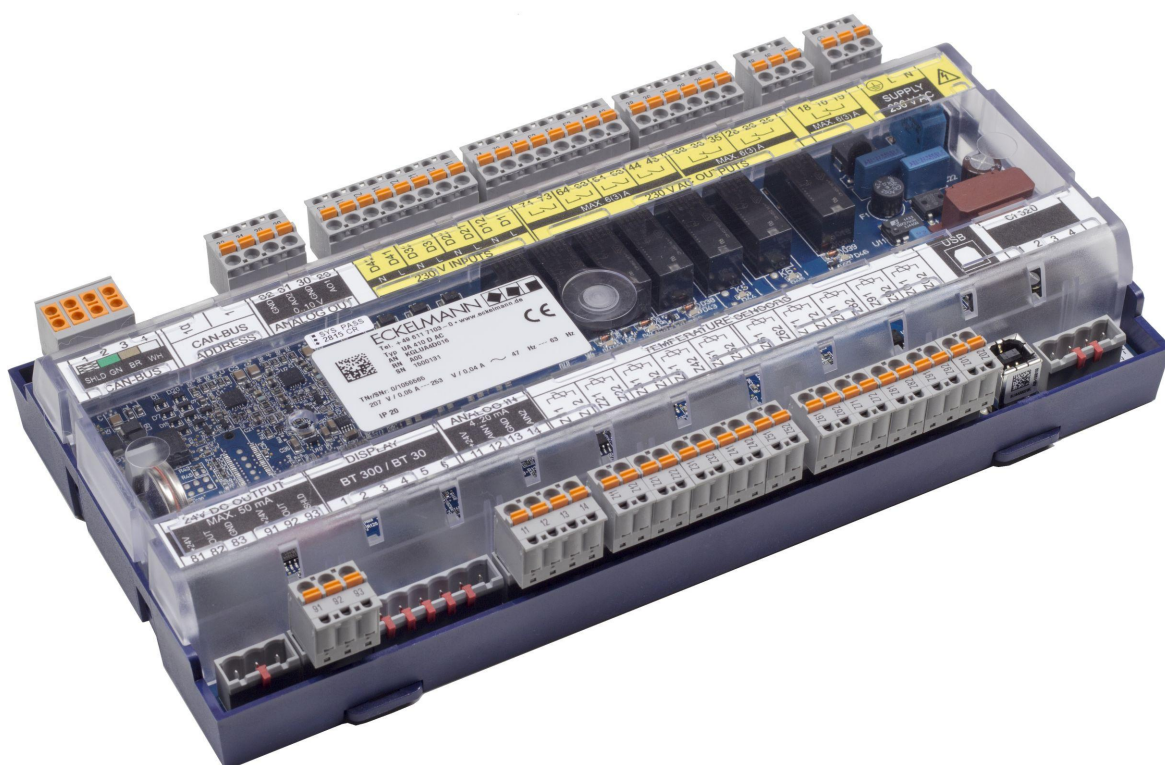

The series UA 400 includes the following expansion stages: UA 400 CC

Eckelmann

Eckelmann AG

Business Unit Refrigeration and Building Automation

Berliner Straße 161
65205 Wiesbaden
Germany

Telephone +49 611 7103-700
Fax +49 611 7103-133

elds-support@eckelmann.de
www.eckelmann.de

Board of Management: Dipl.-Ing. Peter Frankenbach (Spokesman),
Dipl.-Wirtsch.-Ing. Philipp Eckelmann, Dr.-Ing. Marco Münchhof
Chairman of the Supervisory Board: Hubertus G. Krossa

Deputy Chairman of the Supervisory Board: Dr.-Ing. Gerd Eckelmann
Registration court / registration number
District court Wiesbaden, HRB 12636

Before commissioning and use, please check that this is the latest version of the document. With the publication of a new version of the documentation, all previous versions lose their validity. The current operating manual and information such as data sheets, more detailed documentation and FAQs are available for you on-line in E°EDP (Eckelmann ° Electronic Documentation Platform) at

www.eckelmann.de/elds

You reach all relevant documents for this component directly using the QR code:



https://edp.eckelmann.de/edp/lds/_NbH4owBiFn

Information on safety and connection instructions are described in detail in chapter "Industrial safety notes".

Copyright: All rights to any use whatever, utilisation, further development, forwarding and creation of copies remain with the Eckelmann AG company. In particular, neither the contract partners of Eckelmann AG nor other users have the right to distribute or market the IT programs/program parts or modified or edited versions without express written permission. To some extent, names of products/goods or designations are protected for the respective manufacturer (registered trademarks etc.); in any case, no guarantee is assumed for their free availability/permission to use them. The information provided in the description is given independently of any existing patent protection or other third-party rights.

Errors and technical modifications are expressly reserved.

Table of Contents

1	Conventions	9
1.1	Warning signs, symbols and text formatting used in this manual	9
1.2	Explanation of text formatting	10
2	Safety instructions	11
2.1	Disclaimer in the event of non-compliance	12
2.2	Requirements for the personnel	12
2.3	Intended use	13
2.4	Five safety rules according to DGUV Regulation 3	13
2.5	Electrostatic-sensitive components and control components (ESD)	14
2.5.1	ESD - Rules for handling and working	14
2.6	Abbreviations used	14
3	System Design of UA 400	15
3.1	Application	15
3.2	Hardware	16
4	Applications of UA 400	17
4.1	Versions	17
4.2	Controller types	18
4.3	Updating firmware	20
5	Function of UA 400 / UA 410	21
5.1	Starting characteristics	21
5.1.1	First start- reset controller to factory settings	21
5.1.2	Restart - restart of the controller.....	21
5.2	Selection of the temperature sensors	22
5.2.1	Necessary and optional sensors	23
5.3	Controller function	25
5.4	Cooling	25
5.4.1	Temperature control by supply and return air in single-zone operation	25
5.4.2	Temperature control by supply and return air in two-zone operation	27
5.4.3	Temperature control by cold-room air sensor.....	28
5.4.4	Continuous running monitoring	29
5.4.5	Minimum on and off time	29
5.4.6	E*COP+ (SDS TEV).....	29
5.4.7	Two temperature zones.....	30
5.4.8	Heating circuit control.....	30
5.4.9	Operation of cooling relay	30
5.4.10	Start delay after fan	31

5.4.11	Emergency operation	31
5.5	Defrosting	31
5.5.1	Types of defrosting – an overview	31
5.5.2	Defrost in general	32
5.5.3	Discharge gas defrosting (hot gas defrosting).....	38
5.5.4	Brine defrosting	39
5.5.5	Master/slave mode – defrost synchronisation via CAN bus.....	40
5.5.6	Master/slave mode – defrost synchronisation via wiring	43
5.5.6.1	Master/slave mode for the synchronisation of the zones of a single controller.....	44
5.5.6.2	Master-slave mode for the synchronisation of multiple controllers	45
5.5.6.3	Necessary settings for the master / slave mode	46
5.5.6.4	Special features and constraints	46
5.5.7	Defrost sequence (DS) via CAN bus.....	48
5.5.8	Fan control with case and cold-room controllers.....	52
5.5.8.1	Fan control on multidecks	52
5.5.8.2	Fan control - Controller type UA 131	52
5.5.8.3	Fan control - controller type UA 131 LS with enhanced fan control	53
5.5.8.4	Fan control - Controller type UA 131 DD.....	57
5.5.8.5	Fan control - Controller type UA 141 E.....	57
5.5.9	Fan control with cold-room controllers	58
5.5.9.1	Cold-room with defrost heater - Controller type UR 141 TK (LT) only.....	59
5.5.9.2	Cold-room without defrost heater - Controller type UR 141 NK (NT) only	60
5.5.9.3	Heating circuit (controller type UR 141 TK (LT) or NK (NT) only)	60
5.6	Humidification - Controller type UA 141 only	61
5.7	Antisweat heaters.....	61
5.8	Automatic on/off control.....	64
5.9	Door contact	65
5.10	Manual shutdown	66
5.11	Registration of external alarms (e.g. CO2 alarm)	66
5.12	Emergency power operation	67
5.13	Setpoint toggle (day / night operation)	68
5.14	Light control	69
5.15	Refrigeration point disabling	69
5.16	Forced cooling.....	69
5.17	Operating data archiving	70
5.17.1	Temperature recording	70
5.17.2	Temperature recording to EU Regulation 37/2005.....	71
5.17.3	Recording of messages and alarms.....	71

5.18	BT 30 temperature display	72
6	UA 400 installation and start-up	75
6.1	Installation	75
6.1.1	DIN rail mounting of the case/cold-room controller	76
6.1.1.1	Mounting on the DIN rail.....	77
6.1.1.2	Disassembling from the DIN rail.....	79
6.1.2	Handling of the spring terminals.....	80
6.2	Basic settings	81
6.2.1	Setting the CAN bus address	81
6.2.2	Setting of the controller type and master/slave mode	83
6.3	Terminal assignment for 230 V AC power supply	85
6.3.1	Status LEDs	86
6.4	Basic configuration of the controller	88
6.4.1	Naming of the controller	92
6.5	Battery replacement	93
6.6	Firmware Update	95
6.6.1	Requirements for firmware update.....	96
6.6.2	Installing firmware update	98
6.6.2.1	Update for controller with 9-pole DIP switch	98
6.6.2.2	Update for controller with 8-pole DIP switch	102
6.6.3	Rectification of driver problems.....	106
7	Pin and Terminal Assignments of UA 400	107
7.1	Terminal diagram	107
7.2	Terminal assignment of the 230 V AC power supply	108
7.3	Terminal assignment of the 230 V AC relay outputs	109
7.4	Mode of operation of the relay and transistor outputs	111
7.5	Terminal assignment of the 230 V AC digital inputs	113
7.6	Terminal assignment of the 0..10 V analogue outputs	115
7.7	Terminal assignment of the CAN bus terminals	116
7.8	Terminal assignment of the 24 V DC transistor outputs	117
7.9	Terminal assignment of the DISPLAY interface	118
7.10	Terminal assignment of the 4..20 mA analogue inputs	119
7.11	Terminal assignment of the analogue inputs for temperature sensors	120
7.11.1	Sensor identification	122
7.12	Assignment of the USB port	123
7.13	Terminal assignment of the CI 320/TTY interface	124
7.14	Wiring of the master-slave function for defrost synchronization	125
8	Operation of UA 400	126

8.1	Operation possibilities.....	126
8.2	Local operation with a BT 300 x operator interface	127
8.2.1	Lock-down of the setpoint change.....	127
8.3	Remote control via a terminal	129
8.3.1	Menus and operating screens	130
8.3.2	Calling the controller menu via remote control	134
8.3.2.1	System Centre.....	134
8.3.2.2	Store computer CI 3x00 / operator terminal AL 300	135
8.3.3	Deactivating the input lock-down.....	137
8.3.3.1	Store computer CI 3x00 / operator terminal AL 300	137
8.3.3.2	System centre CI 4x00	137
8.3.4	Activating service mode	138
8.3.4.1	System centre CI 4x00 Service-Mode.....	138
8.3.4.2	Store computer CI 3x00 - Service-Mode	138
9	Menu structure UA 400	139
9.1	Controller type UA 111 - menu tree.....	139
9.1.1	Main menu UA 111	142
9.1.2	Menu 1 Actual Values UA 111.....	143
9.1.3	Menu 2 Setpoints UA 111	147
9.1.4	Menu 3 Clock UA 111	155
9.1.5	Menu 4 Messages UA 111.....	158
9.1.6	Menu 5 Archive UA 111	159
9.1.7	Menu 6 Configuration UA 111.....	160
9.2	Controller type UA 111 D - menu tree	170
9.2.1	Main menu UA 111 D.....	173
9.2.2	Menu 1 Actual Values UA 111 D.....	174
9.2.3	Menu 2 Setpoints UA 111 D.....	177
9.2.4	Menu 3 Clock UA 111 D.....	182
9.2.5	Menu 4 Messages UA 111 D	185
9.2.6	Menu 5 Archive UA 111 D.....	186
9.2.7	Menu 6 Configuration UA 111 D	187
9.3	Controller type UA 121 - menu tree	196
9.3.1	Main menu UA 121	199
9.3.2	Menu 1 Actual Values UA 121	200
9.3.3	Menu 2 Setpoints UA 121.....	205
9.3.4	Menu 3 Clock UA 121.....	213
9.3.5	Menu 4 Messages UA 121	217
9.3.6	Menu 5 Archive UA 121.....	218

Eckelmann

9.3.7	Menu 6 Configuration UA 121	219
9.4	Controller type UA 131 / UA 131 LS - menu tree	229
9.4.1	Main menu UA 131 / UA 131 LS	232
9.4.2	Menu 1 Actual Values UA 131 / UA 131 LS.....	233
9.4.3	Menu 2 Setpoints UA 131 / UA 131 LS	238
9.4.4	Menu 3 Clock UA 131 / UA 131 LS	246
9.4.5	Menu 4 Messages UA 131 / UA 131 LS.....	248
9.4.6	Menu 5 Archive UA 131 / UA 131 LS	249
9.4.7	Menu 6 Configuration UA 131 / UA 131 LS.....	250
9.5	Controller type UA 131 DD - menu tree	259
9.5.1	Main menu UA 131 DD.....	262
9.5.2	Menu 1 Actual Values UA 131 DD.....	263
9.5.3	Menu 2 Setpoints UA 131 DD	268
9.5.4	Menu 3 Clock UA 131 DD	275
9.5.5	Menu 4 Messages UA 131 DD	277
9.5.6	Menu 5 Archive UA 131 DD.....	278
9.5.7	Menu 6 Configuration UA 131 DD	279
9.6	Controller type UA 141 - menu tree	288
9.6.1	Main menu UA 141	291
9.6.2	Menu 1 Actual Values UA 141	292
9.6.3	Menu 2 Setpoints UA 141.....	297
9.6.4	Menu 3 Clock UA 141.....	304
9.6.5	Menu 4 Messages UA 141	308
9.6.6	Menu 5 Archive UA 141.....	309
9.6.7	Menu 6 Configuration UA 141	310
9.7	Controller type UA 141 NK - menu tree	319
9.7.1	Main menu UR 141 NK	322
9.7.2	Menu 1 Actual Values UR 141 NK.....	323
9.7.3	Menu 2 Setpoints UR 141 NK	328
9.7.4	Menu 3 Clock UR 141 NK	336
9.7.5	Menu 4 Messages UR 141 NK.....	340
9.7.6	Menu 5 Archive UR 141 NK	341
9.7.7	Menu 6 Configuration UR 141 NK.....	342
9.8	Controller type UA 141 TK - menu tree	352
9.8.1	Main menu UR 141 TK.....	355
9.8.2	Menu 1 Actual Values UR 141 TK	356
9.8.3	Menu 2 Setpoints UR 141 TK.....	362
9.8.4	Menu 3 Clock UR 141 TK.....	371

9.8.5	Menu 4 Messages UR 141 TK	375
9.8.6	Menu 5 Archive UR 141 TK.....	376
9.8.7	Menu 6 Configuration UR 141 TK	377
10	Decommissioning and disposal	387
10.1	Decommissioning / Demounting	387
10.2	Disposal	387
11	Alarms and Messages of UA 400	388
11.1	Alarm signalling and monitoring	390
11.1.1	Cold-room door open alarm	390
11.1.2	High or low temperature alarm	390
11.1.3	Alarm in the event of the absence of a defrost.....	391
11.1.4	Sensor break alarm	391
11.1.5	Suppression of sensor break alarm during defrosting.....	391
11.1.6	Hardware fault alarm	392
11.1.7	Individual allocation of priorities	393
11.1.8	Alarm routes	395
11.1.9	Termination of alarm.....	395
11.1.10	Restart.....	395
11.2	Messages	396
11.2.1	Transient alarms and messages	396
11.2.2	Message log	396
12	Specifications of UA 400.....	397
12.1	Electrical data	397
12.2	Mechanical Data	399
12.3	Mechanical data of the temperature sensor L243 / 5K3A1.....	400
13	Order numbers and accessories of UA 400 / UA 410.....	401
13.1	Case controller	401
13.2	Components	401

1 Conventions

1.1 Warning signs, symbols and text formatting used in this manual

Explanation of the warning signs, symbols and text formatting used in this operating and service manual:

- **DANGER**

 **DANGER**

Instructions with this symbol and/or the signal word **DANGER** warn the user of situations that will cause severe injury or death if the specified instructions are not observed! *

- **WARNING**

 **WARNING**

Instructions with this symbol and/or the signal word **WARNING** warn the user of situations that may cause severe injury or death if the specified instructions are not observed! *

- **CAUTION**

 **CAUTION**

Instructions with this symbol and/or the signal word **CAUTION** warn the user of situations that may cause moderate or minor injury if the specified instructions are not observed! *

* If any of these symbols **DANGER/WARNING/CAUTION** is recognized, the user **must** refer to the operating manual in order to understand the type of potential **HAZARD** and the required actions for avoiding the **HAZARD**. Carefully observe all health and safety instructions and use particular caution in these situations. **Failure to observe the DANGER/WARNING/CAUTION symbols will cause injury (in the worst case, severe injury or death) and/or damage to property!**

- **ATTENTION**

 **ATTENTION**

Instructions with this symbol and/or the signal word **ATTENTION** warn the user of situations that may cause damage to property if the specified instructions are not observed! The **ATTENTION** symbol highlights guidelines and regulations, instructions and proper working procedures that must be particularly observed in order to prevent damage to and destruction of components or malfunctioning. **Failure to observe the ATTENTION symbol will cause damage to property!**

- **NOTICE**

 **NOTICE**

Instructions with this symbol and/or the signal word **NOTICE** provide tips and useful additional information.

• ELECTRIC SHOCK



Risk of fatal electric shock!

This symbol warns of danger from **dangerous voltage** with possible consequences such as severe injury and death. If this symbol is seen, the user **must** refer to the operating manual in order to understand the type of potential **HAZARD** and the required actions for avoiding the **HAZARD**. Carefully observe all health and safety instructions and use particular caution in these situations.

Failure to observe the WARNING symbol will cause injury (in the worst case, severe injury or death) and/or damage to property!

• ESD - Electrostatic-sensitive components and control components



Risk of destruction of the control component / controller!

Electronic components and control components (e.g. circuit boards) are sensitive to electrostatic charges. Circuit boards may only be replaced when the **power supply is disconnected**. Always hold circuit boards by the edges. The guidelines for the handling of electrostatic-sensitive components and control components **must** be observed at all times.

Failure to observe the ESD symbol will cause damage to property!

• DISPOSAL



Potential negative impact on people and the environment due to non-environmentally friendly disposal.

The strike-through dustbin symbol indicates the duty to dispose of items properly. Do not dispose of this product with other domestic waste. Please inform yourself about the local regulations for the separate disposal of electrical and electronic products. The correct disposal of your old equipment protects people and the environment from possible negative impact.

Failure to observe the DISPOSAL symbol will cause damage to people and the environment!

1.2 Explanation of text formatting

Safety instructions or hazard warnings are composed of four elements:

1. The symbol  with text (e.g. for DANGER),
2. a concise description of the hazard and
3. a description of the possible consequences.
4. Where applicable, a catalogue with measures for avoiding the hazard.

For example:



DANGER

Warning of dangerous electrical voltage! Risk of fatal electric shock!

Beware of external voltage at the digital inputs and outputs! Connections/plug connectors of the device may only be plugged in, removed and/or wired when **no voltage is present**.

A **general instruction** consists of two elements:

1. The symbol  with text (including NOTICE, if applicable) and
2. the text of the instruction:

For example:



NOTICE

The current operating manual is available online from the E°EDP (Eckelmann ° Electronic Documentation Platform) at www.eckelmann.de/elds.

2 Safety instructions

This operating manual is part of the device. It **must** be kept in the vicinity of the controller as well as for future use so that it can be consulted when required. The operating manual must be available to the operating and maintenance personnel at all times in order to avoid operating errors. The safety regulations, instructions and information **must be strictly observed and complied with**. During repairs on the entire E*LDS system, the accident prevention regulations and general safety regulations must be strictly complied with. Important information (safety instructions and hazard warnings) are indicated by appropriate symbols, see chapter Conventions. Follow these instructions in order to prevent accidents and danger to life and limb, as well as damage to the E*LDS system!

Always observe the following information:

DANGER

Warning of dangerous electrical voltage! Danger of electric shock!

Beware of external voltage at the digital inputs and outputs! Connections/plug connectors of the device may only be plugged in, removed and/or wired when **no voltage is present**.

- Work on the electrical system may only be performed by **authorised, skilled personnel** (according to the definition of skilled persons in DIN/VDE 0105 and IEC364) while observing the applicable
 - VDE regulations
 - Local safety regulations
 - Intended Use
 - Five safety rules according to DGUV Regulation 3
 - ESD measures
 - Operating manuals
- For safety reasons, the equipment must not be used for any applications other than described in the operating manual and only for the intended use.
- **Before** using the device, check whether it is suitable for your application with regard to its limit values.
- The equipment **must** be installed in an electrically shielded area within the switch cabinet.
- Before connecting the device, it **must** be checked whether the power supply is suitable for the device.
- When using uncoded plug connectors, it is possible to connect them so that there is a danger to life and limb! If this cannot be ruled out, coded plug connectors must be used.
- Specified ambient conditions (e.g. humidity and temperature limits, see chapter Technical Data) **must** be observed and complied with at all times to prevent malfunction.
- **Before** switching on the device, check the correct wiring of the connections.
- The device must **never be operated without** its housing. Before opening the housing, the device **must** be de-energised.
- Note the maximum load of the relay contacts, see chapter Technical Data.
- Note that all supply lines from and to the device, particularly those of the CAN bus and Modbus, must be shielded or installed sufficiently far away from live cables. This prevents faulty measurements and protects the device against electrical interference via the analogue inputs. Connection in parallel of RC elements is recommended for applications with critical environment.
- Contact the supplier in the case of any malfunction.

WARNING

Warning of damage to goods!

In our experience, the transmission of fault messages is not yet functional during the putting into service (no internet connection, no telephone line installed, etc.). It is strongly recommended in such cases to monitor the controller via the CAN bus using a system centre, a store computer or an operator terminal and to enable the transmission of fault messages, for example using a GSM modem via a mobile telephone system. In standalone operation, or as an alternative to monitoring via system centre / store computer / operator terminal, an available alarm contact on the controller must be used to enable the transmission of fault messages via a telephone network.

 For more information, refer to [E*LDS basics](#), [safety instructions](#), [CAN bus & Modbus](#).

2.1 Disclaimer in the event of non-compliance

These operating instructions contain information on the commissioning, function, operation and maintenance of the controls and of the associated components.

 **Observance** of these operating instructions is a prerequisite for safe and trouble-free operation.

2.2 Requirements for the personnel

Special technical knowledge is required for planning, programming, installation, putting into service and maintenance work. This work may **only** be performed by skilled, specially trained personnel. The installation, putting into service and maintenance personnel must have training that authorises them to perform interventions in the system and the automation system. The planning and programming personnel must be familiar with the safety concepts of automation technology. Working on electrical systems **requires special technical knowledge**. Work on electrical systems may only be performed **by instructed electrically skilled persons** or under the guidance or supervision of such persons. The applicable regulations (e.g. DIN EN 60204, EN 50178, DGUV Regulation 3, DIN-VDE 0100/0113) must be observed. The operating personnel must be instructed in how to handle the system / machine and the controller and must be familiar with the operating instructions.

2.3 Intended use

This control system may only be used for the purpose for which it is intended: The UA 400 CC / UA 400 AC control system has been designed for use as case controller in commercial and industrial refrigeration systems with the intended functional scope as described in these operating instructions, and it is to be used under the environmental conditions in these instructions.

Read the safety instructions and the instructions for installation and putting into service, operation and maintenance. THEN start the commissioning and/or operation of the machine / system.

The safety and functionality of the machine / system are only guaranteed for this intended application. Never use the machine / system, its components, control components or parts for any other purpose. The system must not be put into operation until conformity with the applicable EU Directives has been established for the entire system.

2.4 Five safety rules according to DGUV Regulation 3

The following rules must be strictly observed!

1. **Disconnect:** The entire system to be worked on must be disconnected from the power supply at all poles.

DANGER

Warning of dangerous electrical voltage! Warning of dangerous electrical voltage! Danger of electric shock!

Beware of a possible external power supply! **BEFORE** connecting and disconnecting it must be checked that **no voltage is present** at the controller! Connections/plug connectors of the device may only be plugged in, removed and/or wired when **no voltage is present**.

2. **Secure against reconnection:** Attach information signs to the disconnected operating equipment stating:

- What has been disconnected.
- Reason for the disconnection.
- Name of the person who made the disconnection.
- Reconnection must be prevented using a suitable lock (e.g. padlock).

3. **Prove dead (authorised skilled personnel only):**

- Check voltmeter just before use.
- Prove dead on all poles at the disconnection point.
- Prove dead on all poles at the work area.

4. **Ground and short-circuit:** All electrical parts at the work area **must be grounded and then short-circuited**.

5. **Cover or block off adjacent live parts:** If there is live equipment adjacent to the work area, it must be covered using appropriate materials (e.g. insulation blankets / plates).

2.5 Electrostatic-sensitive components and control components (ESD)

All electrostatic-sensitive components and control components (referred to as "ESD" below) are labelled with the warning sign shown. Electrostatic charges arise from friction of insulating materials (e.g. floor covering, items of clothing made of synthetic fibres etc.). Even small charges can result in damage to or destruction of components. Such damage is not always immediately noticeable; in some cases, it does not lead to failure until after a certain operating time.

ATTENTION



Risk of destruction of the control component / controller! Electronic components and control components (e.g. circuit boards) are sensitive to electrostatic charges. Therefore, the guidelines for handling electrostatic-sensitive components and control components must be strictly observed.

2.5.1 ESD - Rules for handling and working

Transport and store ESDs only in the protective packaging provided.

Avoid materials that may produce electrostatic discharge, for example

- Plastic containers and table tops
- Synthetic fibre clothing
- Plastic-soled shoes
- Plastic file covers
- Styrofoam packaging
- Computer monitors, etc.

Preferably wear the following:

- Cotton work clothes
- ESD shoes with conductive soles or leather soles

Use the following:

- Conductive flooring
- ESD workstations equipped with suitable tools (grounded soldering guns, antistatic wrist straps, etc.)
- Conductive ESD bags, conductive plastic containers, IC tubes or cartons lined with conductive foam
- Containers and worktops made of wood, metal or conductive plastics or paper bags

2.6 Abbreviations used

- DGVV Regulation 3 - Accident Prevention Regulation for Electrical Systems and Equipment (previously: BGV A3 - Employer's Liability Association Regulation for Occupational Health and Safety)
- DIN Deutsches Institut für Normung e.V. (German Standardisation Institute)
- EDP: Electronic Documentation Platform of Eckelmann AG
- ESD Electrostatic-Sensitive Device
- ESD Electro-static discharge (Electro Sensitive Devices)
- IEC International Electric Committee
- VDE Verband der Elektrotechnik Elektronik Informationstechnik e.V. (German Association for Electrical, Electronic and Information Technologies)

3 System Design of UA 400

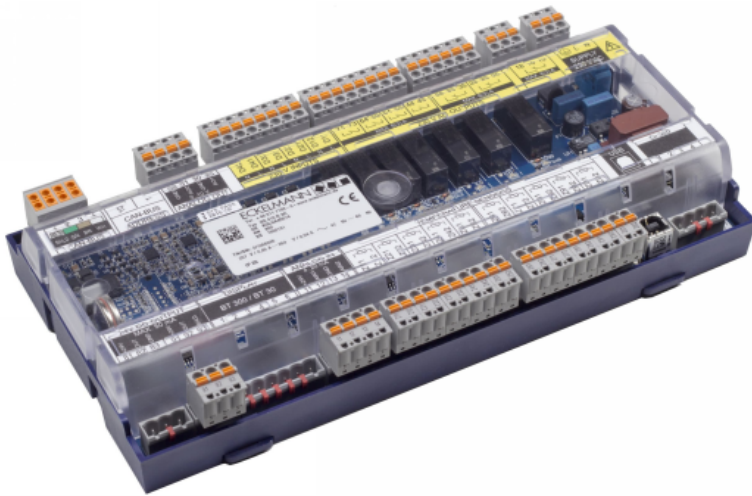

Figure: UA 400 AC - full configuration

3.1 Application

The UA 400 case controller for thermostatic expansion valves (TEV), is suitable for the control and monitoring of up to two temperature zones in refrigerated display cases and cold rooms for normal cooling and low temperature refrigeration (NT/LT).

The appropriate application for refrigerated shelves, refrigerated display cases, island freezers and freezer rooms can be simply set using the DIP switches on the controller. Factory settings for the desired application, tried and tested in praxis, are then loaded.

The use of the case controller for electronic expansion valves offers decisive advantages thanks to a reduced pressure difference between the high and low pressure sides, lower superheat at the evaporator as well as constant conditions for the goods and evaporator thanks to continual regulation. The adaptive suction pressure control generates further savings potential thanks to the load independent increase in suction pressure.

A range of functions for cost and energy saving such as defrost on demand, latent heat utilisation, intelligent fan control, enthalpy controlled frame heating and the constant temperature control of the goods are available with this case controller.

In order to fully utilise its performance features the controller is typically connected to the CAN bus, through which it communicates with further control and monitoring components across the entire network.

Via the CAN bus an intelligent data exchange is carried out with the following system components:

- System Centre / Store computer: Archiving of the operating data as well as alarm and message management, Connection to LDSWin for analysis, configuration and evaluation
- Pack controller: Data exchange between the E*LDS components, Consumer lock (emergency function in the event of pack failure)

A BT 300 x Operator Interface and one to four BT 30 Temperature Displays can be connected to the controller when required. Electrical connections are described in Section [Pin and Terminal Assignments of UA 400](#).

3.2 Hardware

The case controller is housed in a plastic casing for DIN rail mounting and does not require any further optional expansion modules. Up to 99 case controllers can be used within the LDS system. As required, a BT 300 x Operator Interface and up to 4 BT 30 Temperature Displays can be connected. For the direct parameterisation via LDSWin or for a firmware update, the controller can be connected to a laptop or PC via the USB interface. The application range of the case controller is described in more detail in [chapter Versions](#). The following diagram illustrates the system architecture of the UA 410 AC case controller (complete):

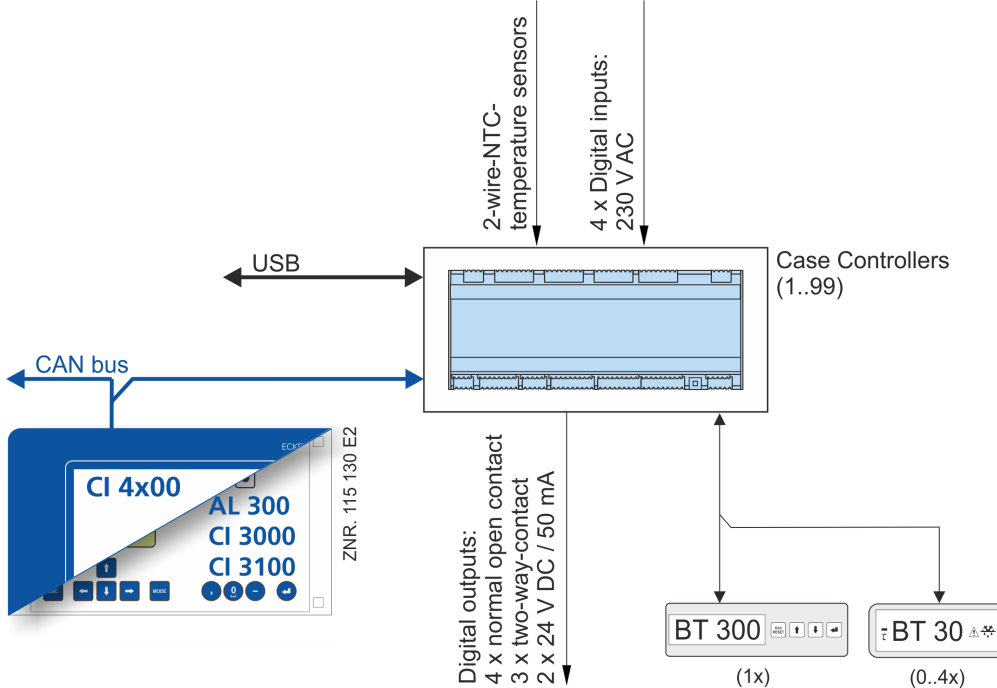

Ports

- CAN bus: Communication in E*LDS-System, new version
- DISPLAY: Connection for BT 300x Operator Interface and up to four BT 30 Temperature Displays
- CI 320: Communication with LDSWin software / Connection to the legacy system CI 320
- USB: For conducting a firmware update

Inputs/outputs

- 4 digital inputs 230 V AC, floating
- 10 analog inputs Connection for two-wire NTC temperature sensors
- Only UA 410 AC: 2 x analogue inputs 4..20 mA - currently without function

Outputs

- 3 relay output 230 V AC / 6 A (changeover)
- 4 relay outputs 230 V AC / 6 A (N.O.)
- 2 transistor outputs 24 V DC / 50 mA (for lighting control and frame heater)
- Only UA 410 AC: 2 x analogue outputs 0..10 V DC - currently without function

Real-time clock

- Only UA 400 AC: Battery-backed, lithium cell

i For precise details of the different features of the controllers UA 400 CC and UA 400 AC see [chapter Controller types](#). The connection and terminal configurations are described in the [chapter Pin and Terminal Assignments of UA 400](#).

4 Applications of UA 400

4.1 Versions

Distinguishing features of the case controllers:

	UA 400 CC *	UA 400 AC * (complete design)
For DIN rail mounting	•	•
For integration in the CAN bus E*LDS system	•	•
Replacement controller for UA 300	•	•
Replacement controller for the LDS1 system (connection to the LDS1 system via the CI320 interface)		•
Suitable for standalone operation		•
With integrated real-time clock (lithium cell power reserve)		•
With integrated archive memory for data recording		•

Abbreviations used

- CC stands for **CAN bus and Cabinet / DIN rail mounting** (C = with CAN bus and C = DIN rail mounting).
- AC stands for **All in one and Cabinet / DIN rail mounting** (All = with CAN bus and real-time clock and C = DIN rail mounting).

i * **Special feature:** The controller is available in two device generations; the DIP switch provides a quick distinguishing feature:

1st generation: since 2011 (8-way DIP switch)



2nd generation: from Oct. / Nov. 2018 (9-way DIP switch)



Note: The range of functions described in this operating manual refers to both device generations.



4.2 Controller types

Case controllers for refrigeration points with thermostatic expansion valves contain a range of different controller types with different fields of application which are summarised as follows:

Controller type		Applications
Case controller	UA 111	Multidecks without defrost heater
	UA 111 D	Multidecks without defrost heater with twin compressor pack
	UA 121	Normal temperature (NT) refrigeration (multidecks, islands, chests, counters) with defrost heater
	UA 131 without fan control UA 131 with fan control	Low-temperature (LT) refrigeration (islands, chests, cabinets, freezer set) with defrost heater, NT cases with defrost heater
	UA 131 LS with enhanced fan control	Low-temperature (LT) refrigeration (islands, chests, cabinets, freezer set) with defrost heater, NT cases with defrost heater
	UA 131 DD	The controller type has been specially developed for use in refrigerated cases that are operated on a refrigeration pack system with 2-pipe hot gas defrost. Since version V2.20, it has replaced the controller type UA 131 A that was suitable for LT islands with twin compressor pack.
	UA 141	Service counters without defrost heater
Cold room controller	UR 141 NK	NT cold rooms with / without defrost heater
	UR 141 TK	NT / LT cold rooms with / without defrost heater and hot gas defrost

For definition of the basic control action, **only one controller type** can be set, which is set using the **DIP switch S3**:

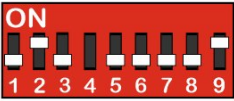
Special feature: Two device generations are available. The DIP switch S3 provides a quick distinguishing feature:

2nd generation controller (from Oct. / Nov. 2018)	1st generation controller (since 2011)
Characteristic: 9-pole DIP switch 	Characteristic: 8-pole DIP switch 

Example: Setting of the coding switches for the controller type UA 131 E; for details, see chapter [Setting of the controller type and master/slave mode](#).

Controller type or master / slave mode		DIP switch S3 (switch positions of the coding switches 1 .. 9)								
		1	2	3	4 Master / Slave mode	5	6	7	8	9 Normal Operation / Firmware Update (only 2nd generation controllers)
Case controller	UA 111	OFF	OFF	OFF	ON/OFF	OFF	OFF	OFF	OFF	ON
	UA 111 D	OFF	ON	ON	ON/OFF	OFF	OFF	OFF	OFF	ON
	UA 121	ON	OFF	OFF	ON/OFF	OFF	OFF	OFF	OFF	ON
	UA 131 without fan control UA 131 with fan control (terminals 73/74)	OFF	ON	OFF	ON/OFF	OFF ON	OFF	OFF	OFF	ON
	UA 131 LS with enhanced fan control (terminals 15/16/18)	ON	ON	ON	ON/OFF	ON	OFF	OFF	OFF	ON
	UA 131 DD	ON	ON	ON	OFF	OFF	OFF	OFF	OFF	ON
	UA 141	ON	ON	OFF	ON/OFF	OFF	OFF	OFF	OFF	ON
	Cold room controller	UR 141 NK	OFF	OFF	ON	ON/OFF	OFF	OFF	OFF	OFF
UR 141 TK		ON	OFF	ON	ON/OFF	OFF	OFF	OFF	OFF	ON

i Operation with an unsupported DIP switch setting is not permitted. In the event of change of the controller type, all parameters are reset to their factory settings.

The controller can be operated via

- a central computer e.g. via network / modem with connection to the system centre / store computer,
- the system centre, a store computer or an operator terminal,
- a local BT 300 operator interface x via the DISPLAY interface on the controller or
- a laptop (PC) with the PC software LDSWin connected via USB.

i For more details, see chapter [Operation of UA 400](#).

4.3 Updating firmware

The case controller is supplied with the current firmware, ready for operation. Future software versions can be loaded into the case controller as required by means of a firmware update, and thus updated.

⚠ Danger data loss! In some cases a change of firmware version can lead to the loss of all the setpoints in the case controller. As a precaution, the settings must be backed up by saving them to the LDSWin PC software, **prior** to the update. After the firmware update the backup settings can be reloaded into the controller from LDSWin. A software update is only to be carried out by trained staff or factory-side by the manufacturer. Further details on firmware updates can be found in [chapter Firmware Update](#).

5 Function of UA 400 / UA 410

 The parameters mentioned in this section are described in [Menu structure UA 400](#). Changing the default settings for these parameters will not normally be necessary. Parameters that cannot be changed are referred to as fixed parameters in the following description.

5.1 Starting characteristics

The following are distinguished for any start-up of the controller:

- First start
- Restart

5.1.1 First start- reset controller to factory settings

 **Caution: data loss!** A first start causes all parameters to be reset to the factory settings!

The first start can be initiated using the following procedure:

1. Disconnect controller from the power supply for safety reasons (see also chapter [Setting of the controller type and master/slave mode](#)) make a note of the DIP switch S3 settings (e.g. OFF-ON-OFF-...).
2. Adjust settings at the DIP switch S3 (e.g. OFF-OFF-OFF-...).
3. Power on the controller again and wait approx. 1 minute while the controller starts up.
4. Disconnect controller from the power supply for safety reasons (see also chapter [Setting of the controller type and master/slave mode](#)).
5. Reset DIP switch S3 to the noted starting position.
6. Switch on controller again.
7. The settings of the controller have been reset to the factory settings.

 A first start is also performed when a different controller version (e.g. UA 400 UA 410 D UA 400 E UA 410 L) is loaded on the controller via firmware update (see chapter [Battery replacement](#)). A sensor scan (Menu 6-1) **must** be performed during commissioning or after a first start! The sensor scan is the only possibility to define the sensors to be monitored; see chapter [Necessary and optional sensors](#).

5.1.2 Restart - restart of the controller

For a restart, the device is restarted with all configured parameters and the CAN bus address set on the rotary switch. A restart can be initiated using the following procedure:

- Disconnection and reconnection of the power supply

5.2 Selection of the temperature sensors

The case/cold-room controller uses two-wire NTC temperature sensors to perform control.



All sensors connected **must** be the same type and parameters are not set separately for the sensors. The type of sensor used can be defined by the Sensor Type parameter (Menu 6-2-5).

The following NTC sensor types are usable:

- L243 (K243) Temperature range -50°C to 50°C ;
Type K243 sensor can be used in place of type L243. Characteristics of these two sensors are identical.
- K277 Temperature range -50 to 50°C
- 5K3A1 Temperature range 0 to 100°C

For details of the dimensions see chapter [Mechanische Daten der Temperaturfühler L243 / 5K3A1](#).

Detailed information on the temperature sensors is contained in the data sheet [Mechanische Daten der Temperaturfühler L243 / 5K3A1](#).

- ⚠** All due care must be exercised when installing temperature sensors. Sensor leads need not be shielded when installed exclusively within the refrigerated display case to be controlled and when interference is not to be expected (for example from power wires running parallel to the leads). Otherwise suitable precautions must be taken to protect the sensor leads from external interference.

5.2.1 Necessary and optional sensors

Depending on the controller type and the operating mode (single-zone operation / two-zone operation), there are necessary and optional temperature sensors for the case controller. A sensor scan is performed automatically during [Erstanlauf - Regler auf Werkseinstellungen zurücksetzen](#) of the controller. The number of scanned sensors can be checked in the menu (6-1) or with the LDSWin PC software. This allows unconnected sensors to be removed from the monitoring for sensor fault.

The following list shows the necessary and optional temperate sensors for the regulation.

Controller type	Sensors necessary for regulation	Optional sensors (advanced functions)
Single-zone operation		
UA 111 / UA 141	R2.1	R2.2 R2.3 R2.4 R4.1 R4.2 R4.3 R4.4
UA 121 / UA 131 / UA 131 LS	R1.1 R2.1	R1.2 R1.3 R1.4 R2.3 R4.1 R4.2 R4.3 R4.4
UR 141 NK	R4.1	R1.1 R1.2 R1.3 R2.1 R2.3 R1.4 R4.2 R4.3 R4.4
UR 141 TK	R1.1 R4.1	R1.2 R1.3 R1.4 R2.1 R2.3 R4.2 R4.3 R4.4
UA 111 D	R2.1	R2.2 R2.3 R2.4 R2.5 R4.1 R4.2 R4.3 R4.4 R4.5
UA 131 DD	–	R1.1 R1.2 R1.3 R1.4 R2.1 R2.3 R4.1 R4.2 R4.3 R4.4
Two-zone operation		
UA 111 / UA 141	R2.1 R2.3	R2.2 R2.4 R4.1 R4.2 R4.3 R4.4
UA 121 / UA 131 / UA 131 LS	R1.1 R1.3 R2.1 R2.3	R1.2 R1.4 R4.1 R4.2 R4.3 R4.4
UR 141 NK	R4.1 R4.3	R1.1 R1.2 R1.3 R1.4 R2.1 R2.3 R4.2 R4.4
UR 141 TK	R1.1 R1.3 R4.1 R4.3	R1.2 R1.4 R2.1 R2.3 R4.2 R4.4
UA 111 D	Not applicable as controller type does not support two-zone operation	
UA 131 DD	–	R1.1 R1.2 R1.3 R1.4 R2.1 R2.3 R4.1 R4.2 R4.3 R4.4

Explanation for the sensor designation

Legend: Ry.x		
y = type of the sensor	1	Evaporator sensor (defrost sensor)
	2	Supply air sensor
	4	Return air sensor / room air sensor
x = case	1..5	case 1..5

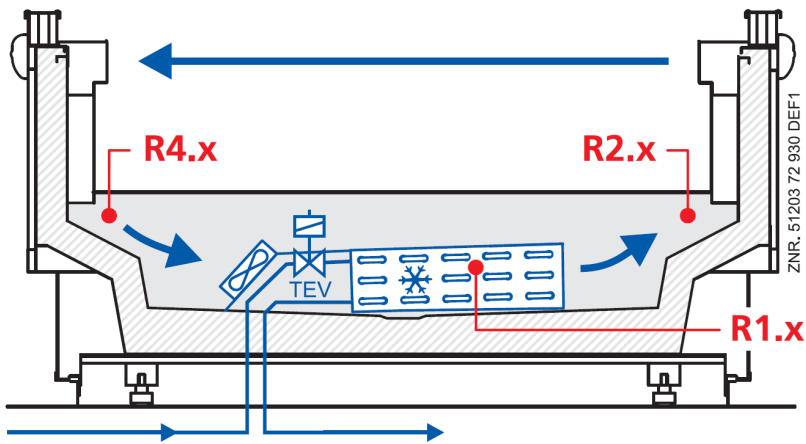

Error message in the event of sensor fault

An alarm (sensor fault) is triggered if necessary sensors are not attached. If optional sensors are not attached, this alarm only occurs if these sensors have been incorporated in a sensor scan. A sensor scan can be initiated in menu 6-1.

- i In the case of optional sensors that are not included in a sensor scan, no actual values are archived in the system centre / store computer.

5.3 Controller function

The sections following describe the various functions of the Case/Cold-room Controller. Availability of certain controller functions depends on the controller type set on DIP switch S3 (see Section [Setting of the controller type and master/slave mode](#)).

5.4 Cooling

5.4.1 Temperature control by supply and return air in single-zone operation

Controller type: UA 111, UA 111 D, UA 121, UA 131, UA 131 DD, UA 141

Double on-off control by supply and return air (type UA 111, UA 121, UA 131, UA 131 DD, UA 141)

Control is made alternatively by two temperature sensors (supply air or return air temperature in pilot case). The cooling relay de-energizes when temperature reaches the setpoint (switch-off value) on one of the two sensors connected. The cooling relay re-energizes with the set hysteresis of the sensor causing switch-off.

Two-stage (twin) control by majority (type UA 111 D only)

Type UA 111 D is a special controller for multideck cases not equipped with a defrost heater and operating on a twin condensing unit.

With its five supply air and five return air sensors, the controller is capable of controlling maximum five case length modules. Compressors are controlled as a function of the majority of all connected temperature sensors of a case line-up. This means that the peak-load compressor will be stopped when temperature reaches the setpoint (switch-off value) on the majority of the connected supply air or return air sensors (e.g. 3 out of 5). The base-load compressor is stopped when temperature reaches the setpoint (switch-off value) on the last remaining supply air or return air sensor. The base-load compressor is restarted when temperature exceeds the switching differential on the majority of the connected supply air or return air sensors. The peak-load compressor is restarted when temperature exceeds the switching differential on all supply and return air sensors. Base load rotation is integrated to avoid varying operating times of the base-load and peak-load compressors.

Base load rotation takes place every time a compressor is started or stopped, not later than every 2 hours. By contrast with the base-load compressor, which starts immediately the start temperature is obtained, the peak-load compressor only starts after a definable start delay has expired (parameter Delay 2nd Comp (Menu 6-3).

 If only one of the two sensors (supply or return air) is fitted, control is made exclusively by the one sensor.

Single-zone operation

Control is made by two temperature sensors (supply air or return air sensor of the pilot case). Cooling can take place in single-zone or two-zone operation.

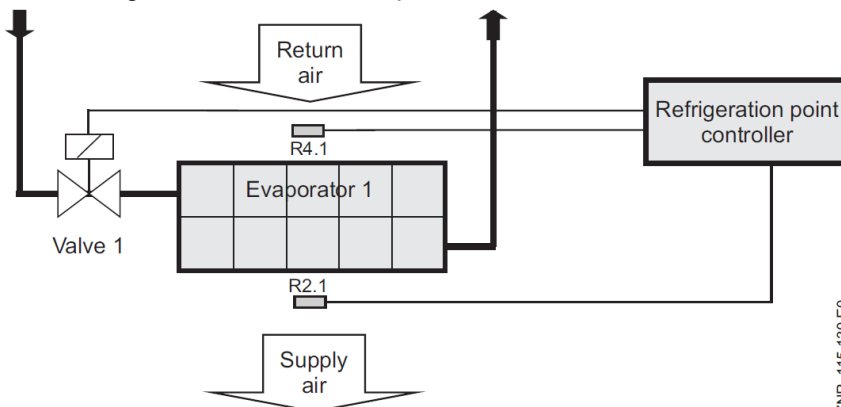

R2.1: Supply air sensor

R4.1: Return air sensor

Eckelmann

Solenoid valve: Relay for Solenoid Valve 1

5.4.2 Temperature control by supply and return air in two-zone operation

Controller type: UA 111, UA 121, UA 131, UA 131 DD, UA 141

Double on-off control by supply and return air (type UA 111, UA 121, UA 131, UA 131 DD, UA 141 only)

Control is made alternatively by two temperature sensors (supply air or return air temperature in pilot case). The cooling relay de-energizes when temperature reaches the setpoint (switch-off value) on one of the two sensors connected. The cooling relay re-energizes with the set hysteresis of the sensor causing switch-off.

i If only one of the two sensors (supply or return air) is fitted, control is made exclusively by the one sensor.

Two-zone operation

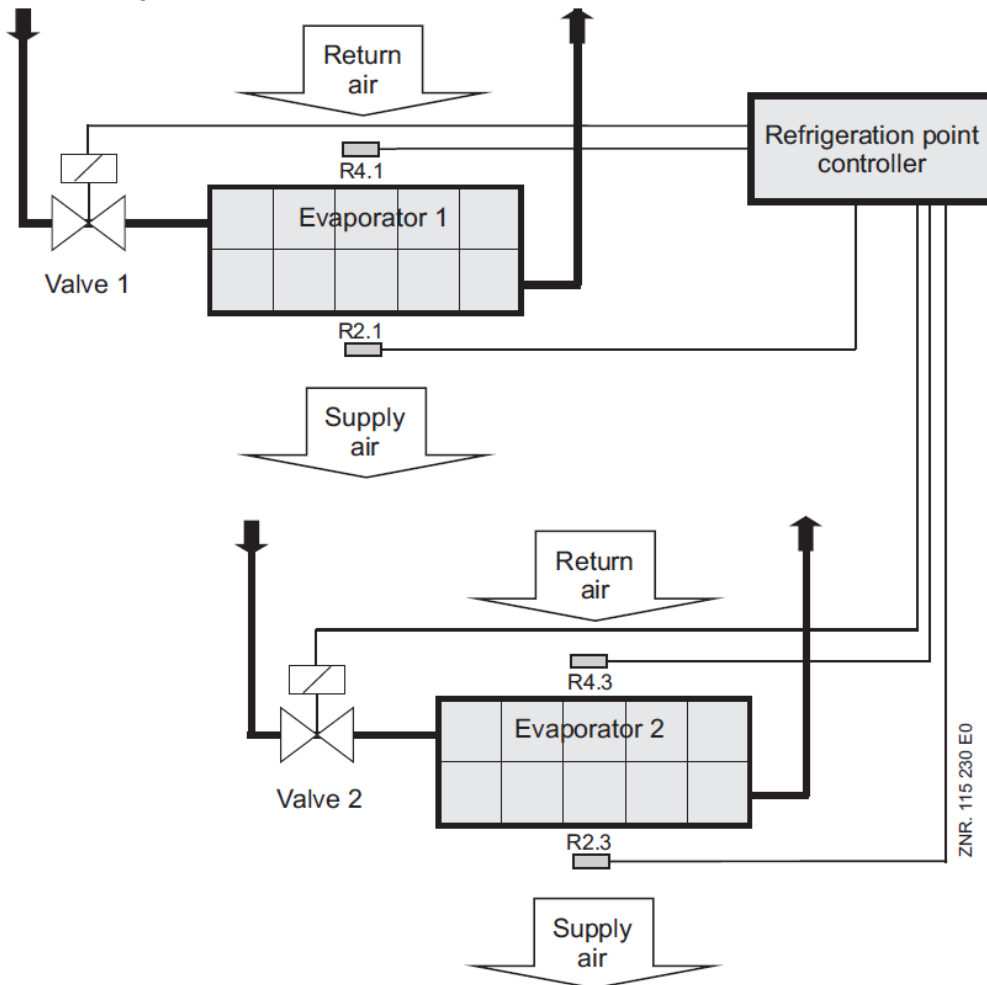

R2.1: Supply air sensor

R4.1: Return air sensor

R2.3: Supply air sensor

R4.3: Return air sensor

Solenoid valve 1: Relay for Solenoid Valve 1

Solenoid valve 2: Relay for Solenoid Valve 2

ZNR. 115 230 E0

5.4.3 Temperature control by cold-room air sensor

Controller type UR 141 TK (LT), UR 141 NK (NT)

Single on-off control

Cooling is controlled by temperature measured on the cold-room sensor. The cooling relay de-energizes when temperature reaches the setpoint (switch-off value) on the cold-room sensor and re-energizes with definable hysteresis.

Single-zone operation

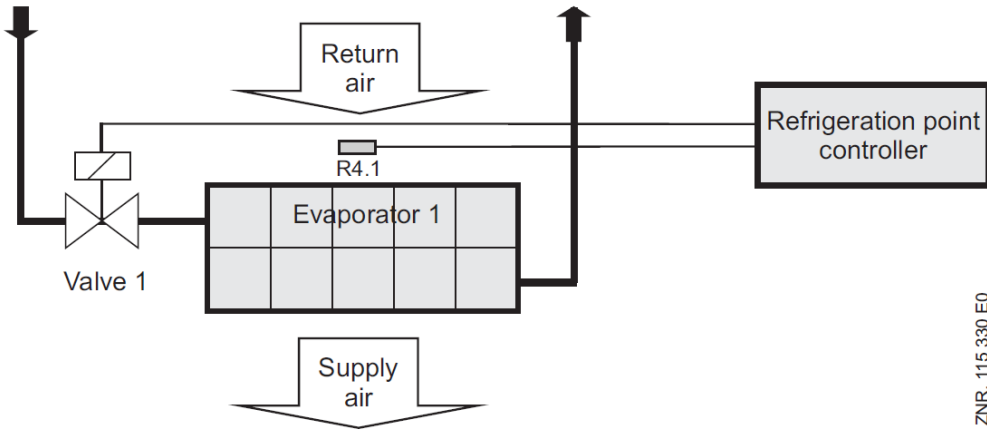

ZNR. 115 330 E0

R4.1: Room air sensor

Solenoid valve 1: Relay for Solenoid Valve 1

Two-zone operation

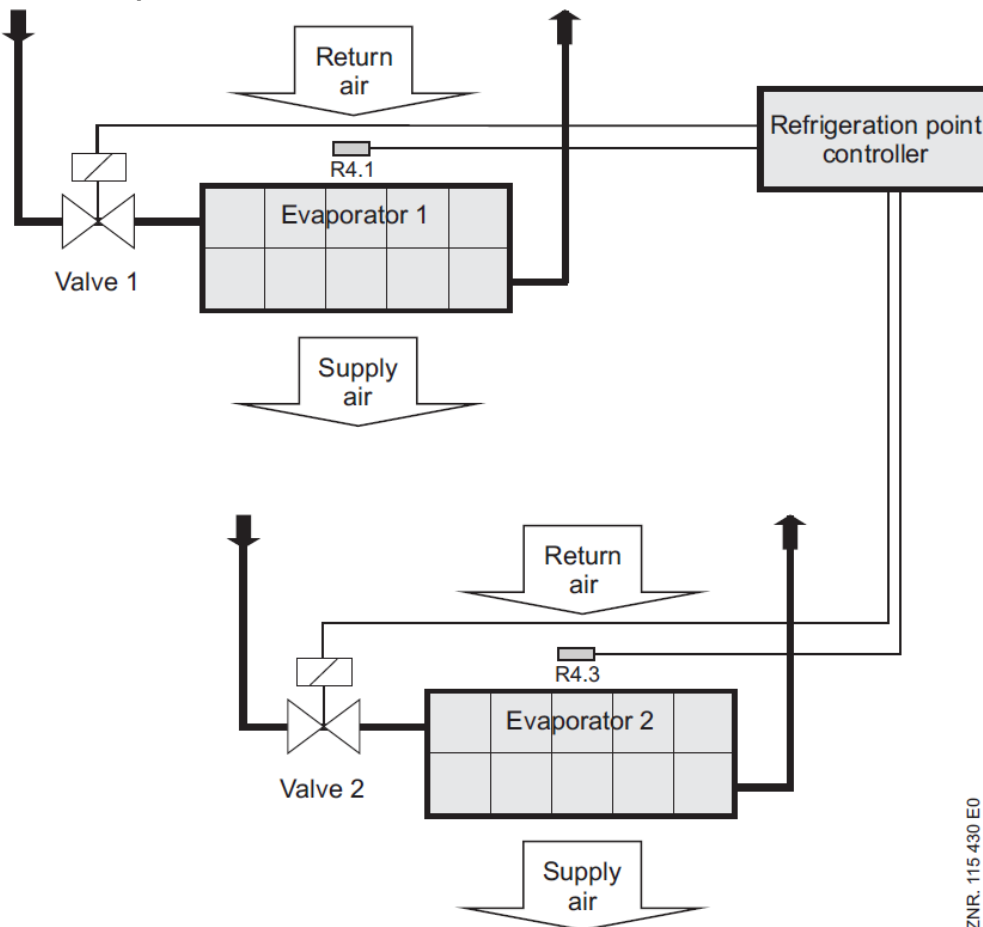

ZNR. 115 430 E0

5.4.4 Continuous running monitoring

Controller type: UA 111, UA 111 D, UA 121, UA 131 DD, UA 141 only

Continuous running of refrigerated cases, e.g. in aggravated ambient conditions, has negative effects especially with multidecks.

It results in icing of the evaporator and reduced air curtain cooling. Run time continuous running monitoring provides for automatic forced shutdown of cooling as a means of preventing icing. This limits the operating time of the cooling.

The duration of these forcibly actuated shutdowns is set via the parameter *Cont Cool Mon.* (menu 6-3).

Commencement of forced shutdown is predefined. When necessary, forced shutdown always takes place 1.5 hours after commencement of defrosting and after each additional hour.

The following condition also applies: If actual supply air temperature drops below SupplyAirSetpoint+1K in one zone, continuous run monitoring is deactivated in this zone for one cycle (1.5 or 1 h).

- ⓘ When forced shutdown is active, it will be terminated before the set duration elapses if temperature rises 4K on the supply air sensor R2.1.

5.4.5 Minimum on and off time

Short-cycling of cooling (i.e. the compressor) can occur when a small hysteresis is set, for example. Monitoring is therefore incorporated to ensure definable minimum on and off times for cooling.

More precisely, this means:

If cooling is stopped by the temperature setpoint being reached, it will remain off until the set minimum on time has expired. If the temperature setpoint is not reached until after the minimum on time has expired, cooling will then be stopped immediately. The same procedure applies to minimum off time before starting cooling.

5.4.6 E*COP+ (SDS TEV)

The auto-adaptive E*COP+ control process dynamically adjusts the suction pressure to the current cooling power requirement. The algorithm evaluates the operating data of all controllers and determines the optimum suction pressure over the respective requesting cooling units. The suction pressure p_0 i.e. evaporation temperature t_0 is raised dynamically as far as possible.

The procedure makes use of the fact that an increase in p_0 i.e. t_0 requires less compression work. Dependent on the operating status, raising the evaporation temperature by 1 K can save ca. 3 % energy. In the case of fluctuating partial loads E*COP+ always finds the ideal operating point and improves the COP (Coefficient of Performance).

In order for the case controller to be included in the control process the parameter *SDS TEV* must be set to ON (see menu 6-7-1) and the corresponding pack number set (see menu 6-1).

- ⓘ Further details are contained in the pack controller operating manual.

5.4.7 Two temperature zones

These controller types generally allow of controlling a line-up of maximum four refrigerated display cases with one temperature zone (pilot case and three add-on cases) or two temperature zones (two pilot cases each with maximum one add-on case).

The pilot cases detect the temperatures necessary for control and input control actuations to the cooling relay. Temperature sensors of the add-on cases are largely monitored or used for defrosting.

Cold-room temperature controllers UR 141 NK (NT) and UR 141 TK (LT) allow of independently controlling two temperature zones (two evaporators). Where required, the evaporators in cold-rooms can each be fitted with two defrost sensors.

5.4.8 Heating circuit control

Controller type: UR 141 NK (NT) and UR 141 TK (LT) only

⚠ Damage to equipment and goods! Faulty adjustment of setpoints entails the risk of damage to the system and merchandise! The setpoint for the heating circuit must be set lower than for cooling. As an alternative to a second temperature zone, the temperature in coldrooms can be controlled with an auxiliary heating circuit. Heating circuit control comprises plain on-off control. The heating circuit control relay energizes when temperature reaches the setpoint and hysteresis. It de-energizes when the temperature exceeds the dead band.

i In this instance the second zone must **not** be selected. Only then is it possible to adjust the setpoints. In order to deactivate the heating circuit regulation the parameter *Ht. Cir. Setp.* (Menu 211 i.e. 213) must be set to "--".

5.4.9 Operation of cooling relay

Operation of the cooling relay conforms to refrigeration safety requirements and is determined by the controller type selected:

- UA 111, UA 111 D, UA 141, UR 141 NK (NT): N.O. control, i.e. cooling is OFF when the case controller is de-energized.
- UA 121, UA 131, UA 131 DD, and UR 141 TK (LT): N.C control, i.e. cooling is ON when the case controller is de-energized.

5.4.10 Start delay after fan

Controller type: UR 141 TK (LT) only

With freezer coldrooms, cooling can be set to start with a definable delay after the fan has started. This function is useful in large low temperature coldrooms to prevent temperature stratification (warm at the top cold at the bottom) in the event of longer evaporator idle times.

In such an instance starting may be delayed while the evaporator fan circulates the cold-room air for a few minutes. If temperature on the sensor then reaches the setpoint, the controller cancels demand for cooling and the evaporator fan stops.

5.4.11 Emergency operation

Cooling can continue for a definable on time (0 to 100%) in the event of failure of temperature measurement or the control temperature sensors (Menu 6-3). The emergency operation interval is 10 minutes, which means that when a 10% on time is set cooling is ON for 1 minute and OFF for 9 minutes of the interval.

-  In emergency operation, cooling alternates for the first and second zones so as to avoid unnecessary load due to simultaneous actuation of refrigeration points.

5.5 Defrosting

-  **Fire hazard!** On grounds of fire prevention, during the planning of the installation a device for shutting down the defrost heating in the event of excessive temperature (e.g. "KLIXON") must be provided.

5.5.1 Types of defrosting – an overview

The following types of defrost are described in the following chapters:

- Chapter [Defrost in general](#)
- Chapter [Druckgasabtauung \(Heißgasabtauung\)](#)
- Chapter [Brine defrosting](#)
- Chapter [Master-Slave-Modus - Abtau-Synchronisation über CAN-Bus](#)
- Chapter [Master-Slave-Modus - Abtau-Synchronisation über Verdrahtung](#)
- Chapter [Folgeabtauung \(FA\) über CAN-Bus](#)

5.5.2 Defrost in general

Defrosting prevents icing of the evaporators due to normal control action. Defrosting is performed by supplementary heating of the evaporator by the off-cycle method. Refrigeration point temperature control is deactivated during defrosting. Defrosting differs for single-zone and two-zone operation.

Defrosting in single-zone operation

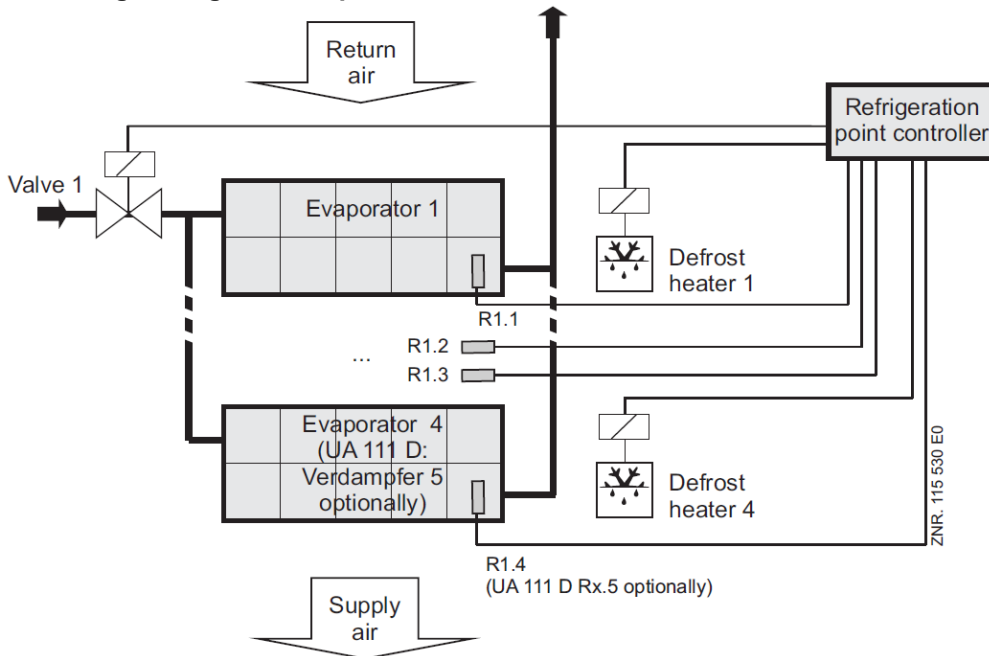

R1.x: Evaporator sensor (with UA 121, UA 131, UR 141 NK/TK, UA 131 DD these sensors are used for defrosting)

R2.x: Supply air sensor (with UA 111, UA 111 D, UA 141) these sensors are used for defrosting)

Solenoid valve 1: Relay for Solenoid Valve 1

Defrost heater 1 to 4: Relay for Defrost Heater 1 to 4 (depending on controller type)

Allocation of sensors to defrost relays

Optional, non-connected sensors are not used for operation of the defrost relays.

Controller type	Required sensors	Allocated defrost relay
UA 111 / UA 111 D / UA 141	R2.1 R2.2 R2.3 R2.4 (R2.5 with UA 111 D only)	Defrost relay 1
	–	Defrost relay 2
UA 121	R1.1 R1.2 R1.3 R1.4	Defrost relay 1
	–	Defrost relay 2
UA 131 / UA 131 DD	R1.1	Defrost relay 1
	R1.2	Defrost relay 2
	R1.3	Defrost relay 3
	R1.4	Defrost relay 4
UR 141 NK(NT) / UR 141 TK(LT)	R1.1 R1.2	Defrost relay 1
	R1.3 R1.4	Defrost relay 2

Defrosting in two-zone operation

In two-zone operation, sensors Rx.1 act on Relay 1 and Rx.2 on Relay 2.

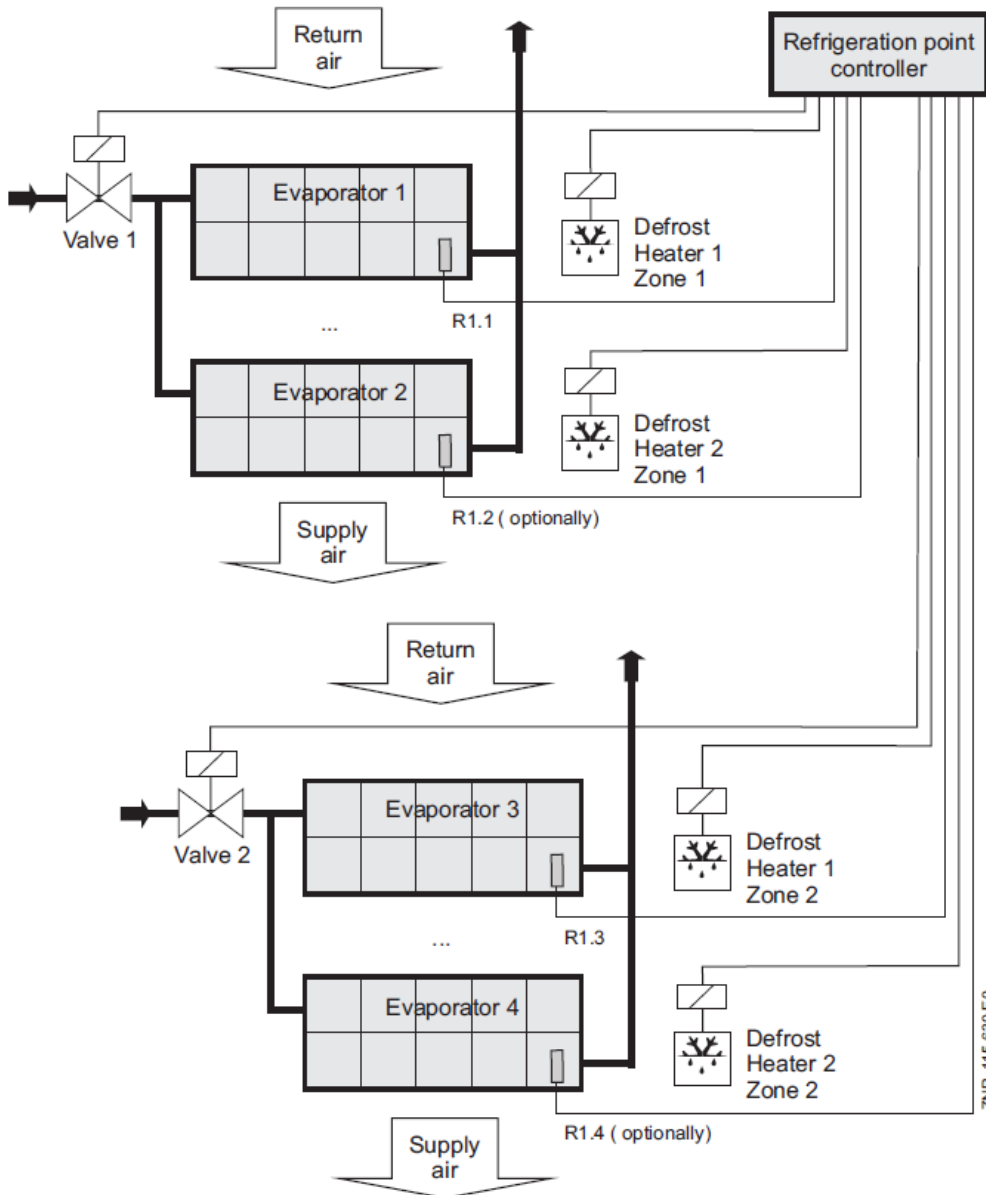

R1.x: Defrost sensor (with UA 121, UA 131, UR 141 NK/TK, UA 131 DD these sensors are used for defrosting)

R2.x: Supply air sensor (UA 111, UA 111 D, UA 141 these sensors are used for defrosting)

Solenoid valve 1: Relay for Solenoid Valve Zone 1

Solenoid valve 2: Relay for Solenoid Valve Zone 2

Defrost heater 1 to 4: Relay for Defrost Heater 1 to 4 (depending on controller type)

Controller type	Required sensors	Allocated defrost relay
UA 111 / UA 141	R2.1 R2.2	Defrost relay 1
	R2.3 R2.4	Defrost relay 2
UA 121	R1.1 R1.2	Defrost relay 1
	R1.3 R1.4	Defrost relay 2
UA 131 / UA 131 DD	R1.1	Defrost relay 1
	R1.2	Defrost relay 2
	R1.3	Defrost relay 3
	R1.4	Defrost relay 4
UR 141 NK(NT) / UR 141 TK(LT)	R1.1 R1.2	Defrost relay 1
	R1.3 R1.4	Defrost relay 2

Defrost initiation

Defrosting can be initiated by four methods:

- **By internal clock (not UA 131 DD)**

 A further defrost can only be initiated after the end of the safe defrost time (defrost parameters), even when the defrost has already been terminated via the evaporator temperatures. Defrosting should be timed to take place between 0200 and 0300 hours where possible so as to avoid problems of missed or duplicated defrosting when changing to or from daylight saving time.

- **Using an external timer** via digital input D11/D12 (factory setting).

 **Warning – hazardous electrical voltage! Danger of electric shock! BEFORE** connecting and disconnecting it must be checked that the 230 V AC digital inputs are off load! The controller and connected voltage carrying components remain supplied with power!

External defrosting without master-slave mode: The external defrost signal must be active for the maximum duration of defrosting. Accordingly the external defrost signal assumes the internal defrost function of Safe Defrost Time. Defrosting is however terminated regardless of the defrost signal being active when defrost termination temperature is exceeded on the defrost sensors.

External defrosting with master-slave mode: The external defrost signal may only be applied only briefly, as in this instance it is only used to initiate defrosting. Maximum defrost duration is again governed by the internal Safe Defrost Time parameter (Menu 3-2). The defrost signal must always be shorter than the internal safe defrost time (minimum 10 sec, preferably not longer than 5 min).

By command signal via CAN bus (manual or higher-level control e.g. Combi Gateway) in every instance, defrosting is not initiated unless the conditions for defrosting are found to be fulfilled. These are:

- Evaporator temperature lower than defrost termination temperature
- In demand defrosting, defrost counter set to 1
- With defrost initiation by internal clock, a new defrost cycle cannot be initiated before the safe defrost time has expired regardless of defrosting being previously terminated by evaporator temperature.

By command from the pack controller via CAN bus (UA 131 DD, UR 141 TK (LT) only):

Defrosting (discharge gas defrosting) is initiated without checking for conditions.

i With controller types UA 121, UA 131 and UR 141 TK (LT) defrosting will also be inhibited when the following conditions are all met:

1. Temperature alarm is active or alarm delay is set to 0 minutes.
2. Evaporator temperature R1.1 or R1.3 is higher than the defined return air setpoint.

Separate defrost start according to the two temperature zones using the internal defrost timer

Usually it is sufficient if the defrost is started simultaneously for both zones. However, should an application require it, a separate defrost for each zone can be carried out. Additional parameters are available for this purpose.

In the E*LDS system, defrost time refers to the time for the start of a defrost. In order to activate separate defrost times for the two temperature zones the parameter *Defrost Timer* must be set to "INT" (menu 3-2-a). The parameters available for this function, „*Safe Defr Time*" and "*Defrost 1..14*" are identical to those for the first zone and can be set as usual.

i The simultaneous deployment of separate defrost zones and the master/slave function is not recommended! If these functions are nevertheless used together, it should be noted that, depending on the parameterization, this can result in very long defrost phases!

Defrost termination

Defrosting can be terminated by three methods:

- By defrost termination temperature being obtained
- By completion of safe defrost time
- By command signal from the pack controller via CAN bus (UA 131 DD, UR 141 TK (LT) only)

Defrost termination by obtaining defrost termination temperature depends on the set controller types as described below:

- **UA 121** Every evaporator has an evaporator sensor. *Single-zone operation*: One defrost relay switches the heaters of 1-4 evaporators. *Two-zone operation*: Two defrost relays switch the heaters of 1-2 evaporators each for 2 zones.
- **UA 131, UA 131 DD** Defrosting is terminated separately for each evaporator by the temperature on the respective evaporator sensor. Defrosting is terminated via the evaporator sensor at least four minutes after the initiation of the defrosting. This applies for initiation via the external contact as well as for initiation via the CAN bus.
- **UR 141 NK (NT)** Defrosting is terminated separately for each evaporator according to the temperature on the respective evaporator sensor (when only one evaporator sensor is fitted) or on both evaporator sensors (when two are fitted). This means that as many as four evaporators can be connected to the controller with off-cycle defrosting.
- **UR 141 TK (LT)** Conditions are the same as for the UR 141 NK (NT). However, with defrosting by electric heater only two evaporators can be connected to the controller, because defrosting is controlled through only two defrost relays.
- **UA 111, UA 111 D, UA 141** Defrosting is terminated jointly for all evaporators when defrost termination temperature is obtained on each supply air sensor connected.

i Defrosting is always terminated by the safe defrost time when defrost termination temperature is set to --. In this instance, no time defrost termination alarm is entered in the alarm log.

Demand defrosting (controller type UA 131, UA 131 DD, UR 141 TK (LT) only)

Demand defrosting means that a decision is made, depending on duration of a previous defrosting cycle, whether defrosting is actually initiated or skipped on becoming due.

A defrost counter is set to 6 at the commencement of defrosting and counts down as a function of the set counting rate until temperature on the evaporator sensor of the pilot case is in the range between -3 °C and +3 °C. Setting the counting rate to 0 deactivates demand defrosting. If the counting rate is set low, the demand defrost counter will count down faster to 1. This means that **all** defrost cycles are indeed initiated when due. If a higher counting rate is set, more defrost cycles will be **skipped** (maximum 5 cycles). If a hot gas defrost is carried out then the defrost counter for the demand defrost is reset.

Waiting time (controller type UA 121, UA 131, UR 141 NK (NT), UR 141 TK (LT) only)

A wait between the time cooling is stopped and the defrost heater is started can be set at the initiation of defrosting. This prevents simultaneous operation of the defrost heater while the evaporator is being pumped down.

Drain time (controller type UA 121, UA 131, UR 141 NK (NT), UR 141 TK (LT) only)

Restart of cooling following defrosting can be delayed by a definable drain time. Drain time does not commence until the last defrost relay de-energizes. This allows drip water to drain from the evaporator before cooling restarts.

Defrosting with two temperature zones

When two zones have been selected for control of cooling, each zone is treated separately for defrosting. Defrost start time is however the same for both zones.

Second defrost stage (controller type UR 141 NK (NT), UR 141 TK (LT) only)

The two defrost stages function can be used for example if a risk exists on a display case fitted with a drain water collecting pan of the pan outlet freezing up when single-stage defrosting is used. To activate a second defrost stage, the controller must be set to one zone by the Temperature Zones parameter (Menu 6-1). This will then display the menu item for a second defrost stage (Menu 2-2-1). Defrosting is initiated by starting the first defrost stage. The second defrost stage is started when evaporator temperature (R1.1) rises above the setpoint for this stage.

Defrost termination is controlled by evaporator sensors R1.3 and R.1.4 for the second defrost stage and by evaporator sensors R1.1. and R1.2 for the first stage. The defrost termination temperature set for Zone 1 is used. The relay for the second defrost stage is the Zone 2 defrost relay.

If the 2nd defrost level is deactivated (parameter 2nd defrost level = "--"), then both defrost relays are employed.

i In the case of discharge gas defrosting the 2nd defrost stage must not be parameterized otherwise the 2nd defrost relay is not activated, as is generally desired with discharge gas defrosting.

Stock compartment on service counters

The relay "Invers defrost" (contacts 63 and 64, invers operation), which interrupts cooling of the stock compartments, is available when configuring case controllers UA 111, UA 111 D, UA 121 and UA 141. This relay is open when cooling is on and closed when defrosting is initiated.

Defrosting of the stock compartments extends for the full safe defrost time and therefore can run longer than defrosting in the 1st or 2nd temperature zone. The relay is not operated until the waiting time has expired.

Manual defrosting (not with UA 131 DD and UA 131 in master-slave mode)

For a manual defrost (e.g. for service purposes), the defrost can be initiated via the system centre / store computer / operator terminal, as follows:

- By opening Menu 5 Remote Operation – Select Refrigeration Point (or CAN bus address) - 3 Clock - 2 Defrost Timer and selecting ON in the line *Man. Defrost* or on the
- Host Computer (see operating instruction description of LDSWin).

i When defrosting is initiated (by controller or in LDSWin) and is terminated or skipped by **demand defrosting / terminated by defrost sensor**, the complete safe defrost time must have expired before manual defrosting can again be initiated. If manual defrosting is to be initiated again immediately following, the first defrost cycle **must** previously be terminated by either of the following: **By controller:** Menu 5 Remote Operation – Select Refrigeration Point (CAN bus address) - 3 Clock - 2 Defrost Timer, set parameter "*Man. Defrost*" (Menu 3-2) OFF. **In LDSWin:** Click on Terminate Defrosting button. Manual defrosting can then be restarted immediately.

5.5.3 Discharge gas defrosting (hot gas defrosting)

Discharge gas defrosting involves feeding discharge gas into the evaporator and can be performed with either hot or cold gas.

The discharge gas is supplied from a point upstream of the condenser (hot gas defrosting) or from the receiver downstream of the condenser (cold gas defrosting).

Compressor damage!

Danger due to liquid refrigerant on the suction side of the compressor! Discharge gas defrosting as described herein is D2D two-pipe discharge defrosting, which can be performed only with hot gas.

Notes on discharge gas defrosting (controller type UA 131 DD, UR 141 TK (LT))

These notes apply to two-pipe discharge gas defrosting. In doing so, the defrost relays are used for the actuation of special solenoid valves for the discharge gas defrosting. In discharge gas defrosting allowance is made for the specific properties of the discharge gas:

- Demand defrost counter ignored on initiation of defrosting
- No internal initiation of defrosting
- No interruption of defrosting in occurrence of temperature alarm
- Discharge gas defrosting requires a pack controller in the system. Case controllers which participate in the hot gas defrosting must be assigned to a pack controller using the parameter *Refr.Sys.No.*. The parameter *Refr.Sys.Type* must also be set for VS 3010 BS pack controllers. No further parameters have to be set here.

Activating discharge gas defrosting on UR 141 TK (LT):

Discharge gas defrosting is always active on the UR 141 TK (LT) and does not require any further parameter setting.

Termination of discharge gas defrosting on UA 131 DD:

Defrosting is terminated by the defrost termination temperature sensors at the earliest 4 minutes after defrost initiation.

Termination of discharge gas defrosting on UR 141 TK (LT):

Defrosting is terminated by the defrost termination temperature sensors without delay. If an internal defrost timer is set on the UA 141 TK (LT), it will be changed automatically to external defrosting by the pack controller the first time discharge gas defrosting is initiated. This prevents the case controller from automatically initiating defrosting.

 **Compressor damage! Danger due to liquid refrigerant on the suction side of the compressor!** During the first start of the UA 131 a defrosting is initiated immediately following the start. If the installation is not secured with suitable pack controller control lines for initiating the discharge gas defrosting, liquid refrigerant can e.g. enter the suction hose. Therefore care must be taken with applications with discharge gas defrosting that the manual defrost is deactivated following the start of the controller and that the defrost timer is set to external defrost. Alternatively, i.e. in addition, the activation of the regulator control elements specific to the discharge gas can be secured using suitable control lines, e.g. from the pack controller.

 Discharge gas defrosting cannot be used together with the master-slave function. With discharge gas defrosting the operation must be terminated when the CAN bus defrost command ends. With master-slave defrosting the operation would normally continue until the safe defrost time expires.

5.5.4 Brine defrosting

Defrosting with brine may be considered a special form of discharge gas defrosting (hot gas defrosting). The brine defrosting is initiated and ended via the CAN bus by the pack controller. A special feature of brine defrosting consists in synchronized operation of the cooling relay and defrost relay, meaning that the cooling relays remain open during defrosting.

Cooling relays and defrost relay are energized on initiation of brine defrosting. The display (Actual Values menu on controller or in LDSWin) shows cooling to be off, as the cooling relays then assume a defrost function and not a cooling function.

The defrost relays and cooling relays are de-energized separately by zones when defrost termination temperature is obtained on the defrost sensors. Cooling does not resume until defrosting is terminated by the pack controller via the CAN bus.

 Demand defrosting is ignored when brine defrosting is initiated. Any waiting time set is disregarded on initiating brine defrosting. The defrost timer switches from INTERNAL to EXTERNAL when brine defrosting is initiated.

Fan controller - case controller

UA 111; UA 121; UR 41 NK (NT); UA 111 D: Fans are switched to continuous running during brine defrosting.
UR 141 TK (LT); UA 131 DD: Fans are switched off during brine defrosting.

Fan controller - cold-room controller

UR141 NK (NT) / UR 141 TK (LT): Heating circuit and second defrost stage are controlled as before in single-zone operation. The second cooling relay remains off however during brine defrosting in single-zone operation and does not simulate the second defrost stage.

5.5.5 Master/slave mode – defrost synchronisation via CAN bus

All controller types versions \geq V4.00

⚠ Damage to the installation and stock loss! When using this function, it must be ensured that **incorrect parametrisation** does not result in simultaneous defrost and cooling of the synchronised refrigeration points.

Requirements

- Setting of the DIP switch S3, coding switch 4 **must** be set to **OFF**; for details, see chapter [Setting of the controller type and master/slave mode](#).

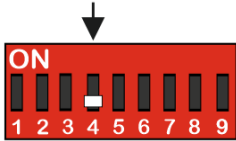

- Software settings, see below for details.

Function Description

The master/slave mode is used for refrigerated cases, for which the operation of multiple evaporators can result in reciprocal icing of the evaporators without further protective measures.

This problem is prevented due to the defrost synchronisation in master/slave mode. All refrigerated cases and case zones defrost simultaneously and then switch to cooling together. For this type of master/slave mode, multiple involved controllers are synchronised via the CAN bus.

The master/slave defrost covers the following function: Following a joint defrost, a group of controllers only switches back to cooling when all the controllers have completed their respective defrost. Therefore, the transition from defrost to cooling operation is synchronised for all the case controllers in a defrost group.

The case controllers in the defrost group are divided into one defrost master and the defrost slaves. The defrost master sets the defrost start, and at the end of the process, enables cooling again. All the other defrost participants (when existing) are called defrost slaves and follow the instructions of the defrost master. Several independent defrost groups can be realised, i.e. a number of defrost masters who each administer an arbitrary number of defrost slaves. In addition to the defrost groups, further controllers entering defrost within the system can exist independently of the groups.

The size of the defrost groups as well as the number of defrost groups is only limited by the maximum number of participants in the E*LDS system.

Execution or sequence of the master/slave defrost via the CAN bus

A defrost is initiated at the master. From this point in time, all the slaves enter a defrost. As long as any of the participants (slaves or the master) is still in defrost, none of the controllers involved will switch to cooling.

If the defrost end temperature has been reached at one of the controllers, this controller sets its own defrost relay to OFF, but remains in the defrost state and does not change to the cooling state.

When all controllers involved have reached the end of the defrost cycle (whether via the safety time or via the defrost termination temperature), they all return to the "cooling" state together.

The safety time set at the master and any waiting or dripping time set at the master is also used by the slaves.

Configuration / parametrisation of master/slave defrost via CAN bus

The controllers must be configured so that defrosting can take place. In the case of the master, a defrost is activated via the internal clock, the external contact or via manual defrost (CAN/local). The master, with respect to the parameter "M/S Abt Fkt" must be set to "Master" (menus 2-2-1 and 2-2-2). The parameter "M/S CAN Adr." is of no relevance for the master.

i It is recommended to set the parameter "M/S CAN Adr." on the master to "—".

The slaves, with respect to the parameter "*M/S Abt Fkt*" are set to "*Slave*". The parameter "*M/S CAN Adr.*" **must** be set to the CAN address of the master controller, and that for all participating slave controllers.

Application special case - Synchronisation of both defrost zones

If the M/S CAN address on a slave is set to "—", then a defrost via internal and external defrost timers is possible. This enables both zones of the respective controller to be synchronised so that they return to cooling simultaneously following the defrost.

Short guide

1. Set which controllers should defrost or switch to cooling together. Define one of the controllers as the defrost master.
2. Configure the defrost master (e.g. controller with CAN address 11) as follows: under 2 Setpoints - 2 Defrost - 1 Zone 1:
 1. Set M/S Abt. Fkt.Master and
 2. M/S CAN Adr. to "--"
3. Configure all slaves as follows: under 2 Setpoints – 2 Defrost – 1 Zone 1:
 1. Input M/S Abt. Fkt Slave and
 2. M/S CAN Adr. (CAN address of the master, e.g. 11)
4. Configure defrost on the master,
 1. safe defrost time and defrost times or external defrost in menu 3 Clock - 2 Defrost timer (note: during master / slave operation, the controller always reacts to the external defrost timer even if defrost timer has been set to INT).
 2. defrost termination temperature, wait time and drip time for zones 1 and 2 in the menus 2-2-1 and 2-2-2 (note: the slaves adopt the wait time and the drip time from the corresponding zones of the master. If the master should operate in single-zone mode, a slave in two-zone mode adopts the wait time and drip time from zone 1 of the master for for both zones).
5. Check whether the sensor for the defrost termination temperature (R1.x) is connected and is supplying plausible values.

Necessary measures for the parametrisation of the master/slave defrost via CAN bus

- The safe defrost time of the master is also applicable for the slave controllers. Possibly deviating values set at the slave controllers are not taken into account:
- The wait and drip times of the master are also applicable for the slave controllers. Possibly deviating values set at the slave controllers are not taken into account:
- The initiation of a defrost (manual, external, internal, CAN) on a slave node is not permitted and will be prevented.
- Exception: Slaves with the M/S CAN address = "—" can have external defrost sources (see Special Application Case).
- The defrost on demand only functions on the master. Any possibly parametrised defrost on demand for the slave controllers will be ignored.
- The defrost termination temperature must be set individually for each slave controller.

Status values

The total number of controllers participating in the master/slave process is displayed in menu 1-3 (parameter "*M/S Anz. Sl.*"). The number is recalculated with each reset and setting of the parameter "*M/S Abt Fkt*" to "*Master*".

In addition, menu 1-3 also displays the last UA that did not give any feedback to the master during defrost (parameter "*M/S verl. Sl.*"). If the defrost proceeded without error, this value is "--".

If a defrost is requested at the master (defrost timer, manual or external) and the master itself has already reached the defrost termination temperature, it does not defrost and defrosting of the slaves is not initiated at all.

Behaviour of a Master/Slave CAN slave when it receives a defrost request from a master and the defrost condition is not fulfilled (slave too warm): the slave does not defrost and does not cool while the cooling remains blocked by the master.

Alarm signalling when defrost is not performed

The "No Defrost" message is output by both the master as well as the slave controller if the defrost was not performed. The output of this message is linked to the delay time for this alarm and is therefore automatically sent by all affected controllers if no defrost takes place. In master/slave operation the alarm "No Defrost" can also mean that a slave no longer has any contact to the master. If a slave fails to receive a signal from its defrost master for a period longer than 60 minutes, then this message is generated.

Special cases/useful information

- The master/slave defrost via CAN bus cannot be used together with the wired variant of the master/slave defrost.
- UA 400 / UA 400 E mixed operation is possible with both the master/slave defrost (MSD) and the consecutive defrost (CD).
- Once a defrost has been initiated on a slave, this can only be interrupted when the parameter 2-2-1 (Defrost 1) – "M/S Abt Fkt." on the slave is set to "OFF" for a minimum of 10 seconds and then reset to "Slave". In general, this procedure is only recommended for commissioning situations, as an interruption in defrosting can result in increased icing.
- Slaves with the M/S CAN address = "—" can have external defrost sources
- Slave with M/S CAN-Address "—" -> defrost via INT / EXT possible
- The master does not start the defrost of the slaves if it has already reached the defrost termination temperature.
- Even if all the slaves have already reached their defrost termination temperature, they do not switch to cooling until the end of the delay time.
- The master does not switch on the defrost heater (= relay is NOT activated) if it is already too warm.
- Safe defrost, delay and drip times are transmitted to the slaves from the master during both a master/slave defrost (MSD) and a consecutive defrost (CD) and are used irrespective of the slave parameters set by the user.

5.5.6 Master/slave mode – defrost synchronisation via wiring

All controller types versions \geq V4.00

⚠ Damage to the installation and stock loss! When using this function, it must be ensured that **incorrect parametrisation** does not result in simultaneous defrost and cooling of the synchronised refrigeration points.

Requirements

- External wiring on hardware side; for details, see chapter [Wiring of the master-slave function for defrost synchronization](#).
- Setting of the DIP switch S3, coding switch 4 **must** be set to **ON**; for details, see chapter [Setting of the controller type and master/slave mode](#).

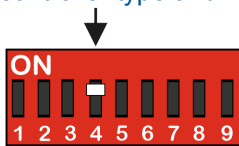

⚠ This function requires **additional external** wiring for multiple participating controllers. It must be ensured for the wiring of master and slave case controllers that the power supply is only implemented with **one phase** (e.g. only via L1).

Function Description

The master/slave function is used for refrigerated cases when the operation of several evaporators, without additional protective measures can result in the reciprocal icing of the evaporators (all controller types except UA 131 DD).

This problem is prevented due to the defrost synchronisation in master/slave operation. All refrigerated cases and case zones defrost simultaneously and then switch to cooling together. Multiple participating controllers are synchronised via hardware wiring, see [chapter Wiring of the master-slave function for defrost synchronization](#). In addition, in the case of **one** controller in two-zone operation, this can be used to force the joint return of both zones to cooling following a defrost.

5.5.6.1 Master/slave mode for the synchronisation of the zones of a single controller

Operation

Master configuration: The internal defrost timer must be active for the case controller (menu 3-2, parameter *Abtauuhr = INT*). This case controller is then designated as the master. On reaching the defrost end temperature for the respective zone the defrost relay is switched off. Cooling is only resumed once all the control zones have completed the defrost or the safe defrost time has elapsed.

 Further details of special features and limitations are provided in [chapter Besonderheiten und Einschränkungen](#).

Example: Synchronised defrost termination for **one** controller with two temperature zones

In standard operation with two temperature zones, the defrost in each zone is terminated dependent on the defrost termination sensor of the respective zone and then immediately switched to cooling. On the other hand, if an operating mode is required where both zones should simultaneously switch to cooling after the defrost, the coding switch 4 on the DIP switch S3 must also be set to ON for the master/slave function.

In this case, the cooling operation does not restart until both zones have finished defrosting. The relay for the defrost heater continues to be switched individually for each zone according to the temperature of the defrost termination sensor.

The special features and limitations for the master then apply, see [chapter Besonderheiten und Einschränkungen](#).

5.5.6.2 Master-slave mode for the synchronisation of multiple controllers

Operation

Master configuration: The internal defrost timer must be active on one of the participating case controllers (menu 3-2, parameter *Abtauuhr = INT*). This case controller is then designated as the master.

Slave configuration: The other case controllers must be configured for external defrost start (menu 3-2, parameter *Abtauuhr = EXT*). These are then automatically slave case controllers.

i Further details about special features and limitations are explained in [chapter Special features and limitations](#).

The defrost relay is switched off when the defrost termination temperature of the respective zone is reached. Cooling is only resumed when all the control zones of all the participating controllers have completed the defrost or the safe defrost time has elapsed.

Defrost process example

Case controller UA M is configured as master. Case controller UA S is configured as slave. The synchronised master / slave defrost process is initiated using the integral defrost timer:

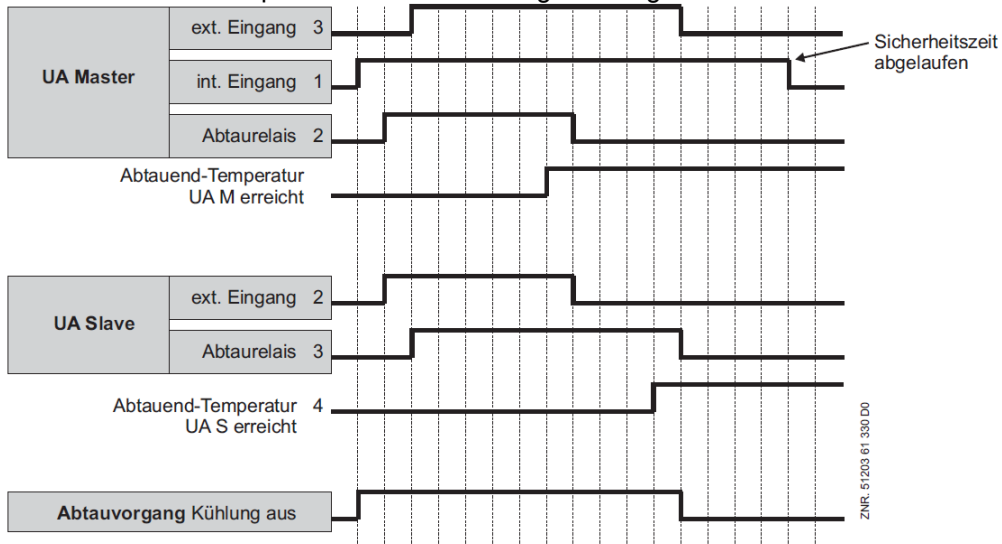

The following must be noted for this example: The internal defrost signal is present over the entire safe defrost time. However, the end of the defrost process generally depends on switching off the last defrost relay.

5.5.6.3 Necessary settings for the master / slave mode

- **Controller - Hardware**

In order to activate the master/slave mode, the coding switch 4 on the DIP switch S3 on the case controller **must** be set to **ON**.

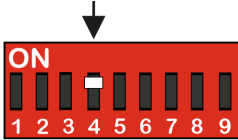

The change is not adopted until the controller is restarted (switch off and then switch on again).

i Explanations for the master / slave wiring are described in the chapter [Wiring of the master-slave function for defrost synchronization](#).

- **Controller - Software**

The activation of the Master / Slave mode can be checked in the menu 6-2-1.

5.5.6.4 Special features and constraints

All defrost relays are energized simultaneously at the commencement of defrosting. As defrosting proceeds, the evaporator defrost relays are de-energized separately and exclusively as a function of defrost termination temperature.

i Return to cooling mode is not however made until defrosting is completed on all synchronized cases. Defrosting can be carried out on the master by inputting a signal to the defrost input. It is possible to send a defrost command from the master to the digital input D11/D12 of the slave via a 230 V AC impulse (parameter Eing. 1 must be set to ABTAUJHR, see menu 6-2-4).

All the characteristics of the defrost function such as defrost on demand, defrost via CAN bus and manual defrost are preserved by the master case controller and also need to be parameterized here (on the master).

Configuration

The master-slave function can be employed with all controller types. In order to activate the master/slave mode DIP switch 3 on coding switch 4 must be switched to ON on all participating case controllers. The change is only adopted when the controller is restarted (switched off and back on again).

i The set controller mode and activation of master-slave mode can be checked in the Type and Version menu 6-2-1.

The following items must definitely be observed to **ensure** correct operation.

⚠ Damage to equipment and goods!

- Faulty setting of coding switches and defrost timer (INT/EXT) can result in evaporator icing due to non-synchronised defrosting or failure of defrosting to take place!
- Demand defrosting works only on the master case controller. The initiation of a manual defrost on the slave is also prohibited.
- Due to a defrost on demand configured in a slave it is possible that the master defrosts while the slave continues to operate in cooling mode.
- The safe defrost time for the slave must be exactly the same as the safe defrost time for the master in order to prevent one of the two case controllers switching to cooling mode before the other as a result of the elapse of a safe defrost time
- Counting rate for demand defrosting must be set to zero (0) on the slave controller. The Waiting time for commencement of defrosting must not be set to any other value but 0 on the slave, as otherwise defrosting on master and slave will not be synchronised.
- Operation with 1 or 2 temperature zones is possible. Defrost on demand only functions on the master case controller. On the slave the counting rate for the defrost on demand must be set to the value 0 (zero).
- When using an external defrost timer on a master its internal defrost timer should be set to "—". If this is not the case then the internal defrost time will be taken into account along with the external defrost. The signal from the external defrost timer may only be employed as an impulse (> 10 seconds) for the initiation of the defrost. In order to configure the master's defrost timer the parameter *Defrost Timer = INT* must also be set, see menu 3-2.
- Manual defrosting cannot be initiated on the slave case controller.
- The *No Defrost alarm* applies to master and slave. Demand defrosting on the master can lead to this fault report being generated erroneously on the slave, for example when monitoring time is set too low. Any drain time set will not commence until defrosting has been fully completed and cooling resumes.
- Any drip time which may have been set will only begin when the defrost has been completed and cooling has resumed.
- Once defrosting is started by the internal clock, no new defrost cycle can be initiated until the safe defrost time has expired even though the controller may have returned to cooling mode before then.

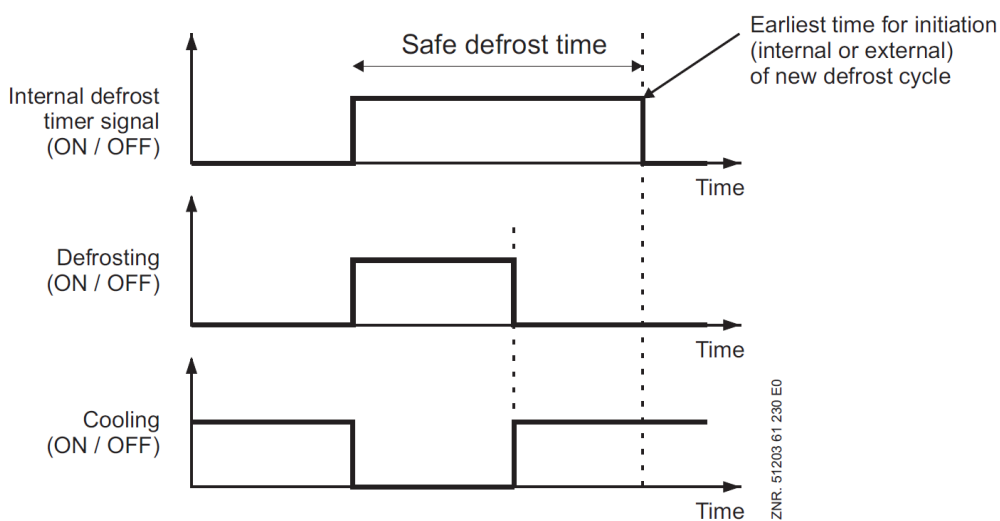

5.5.7 Defrost sequence (DS) via CAN bus

All controller types from version \geq V 4.00

Function description

Defrost sequins (DS) via CAN bus covers the following functions:

Different refrigeration points, organised into groups, are to start their defrost at different times. A common application is the temporal distribution of the energy requirements generated by the defrost, together with the shortest possible total defrost time for the store. Simultaneously, the total time required for the completion of all the participating defrosts is kept as short as possible.

As soon as one of the defrost groups has completed its defrost, then the next group can start its defrost. A delay time can be specified for the period between two defrosts. The organisation of the defrost groups is carried out by the defrost sequence master (DS master). All other participants in the defrost sequence are called defrost sequence slaves (DS slaves).

It is possible to deploy several independent defrost sequence masters within one CAN bus segment. In addition to the groups of defrosting controllers, there can be further controllers within the E*LDS system which independently conduct a defrost.

The number of DS masters as well as the number of controllers assigned to them is only limited by the maximum number of participants in the E*LDS system.

Within a defrost sequence system (master and its assigned slaves) the sequence is established by group numbers. The allocated group numbers are defrosted in ascending order beginning with group number 1. If several controllers assigned to a DS master have the same group number, then they are termed a group (DS group) and are defrosted at the same time. The group with the next group number is only defrosted when all the participants in the previous group have completed their defrost.

Execution i.e. sequence of the defrost sequence

A defrost is initiated on the master controller for the defrost sequence (DS master).

 The DS master **always** belongs to DS group 1!

The DS master initiates a defrost of all the DS slaves in group 1. If there are no DS slaves with the group number 1, then the DS master defrosts alone. All the controllers (DS slaves) with other DS group numbers continue to operate in their normal cooling mode.

If the defrost termination temperature is reached by **all** the controllers of the DS group or their safe defrost times have elapsed, then the DS master initiates a defrost for the next highest DS group number.

If a delay time "*DS-Wait time*" (menu 2-2-1, i.e. menu 2-2-2) has been parameterized then the start of the defrost sequence for the subsequent DS group is delayed accordingly.

The defrosts are continued until the entire chain of controllers has been run through. The defrost sequence is now finished and all controllers have resumed cooling.

Configuration / parameterization of defrost sequence

The defrost is parameterized in menu 2 – Setpoints – 2 Defrost Zone 1.

The first thing to be configured is the function of the controller with respect to the defrost sequence (master or slave, i.e. OFF if the controller is not to participate in the defrost sequence, parameter "*DS-Function*").

In the case of the slaves the corresponding DS group (parameter *DS-Group*) and the CAN bus address of the DS master (parameter *DS-Master*) must be set. The DS master is automatically in DS group 1, if it is set to a different group this has no effect on the master. Furthermore, the delay time between two group defrosts must be set on the DS master.

Example: Configuration of a defrost sequence

Start of defrost

In the case of the DS master controller a defrost is activated via the internal clock, the external contact or via manual defrost (CAN/local).

Configuration of the group members

With respect to the parameter "*DS-Function*", the DS master must be set to "Master". The parameter "*DS-Wait time*" specifies the delay time in minutes which the DS master maintains between the defrosting of two groups. The delay time applies unchanged across all groups.

The parameters "*DS-Group*" and "*DS-Master*" are ignored by the DS master and should be set to "--".

With respect to the parameter "*DS-Function*", the DS slaves must be set to "Slave".

On the slaves the parameter "*DS-Group*" must be set so that the controller is defrosted in the desired group with other controllers and/or in the desired sequence relative to other controllers. For purposes of clarity, the group numbers should be assigned in ascending order and without omissions along with the CAN bus address, however this is not obligatory.

With the parameter "*DS-Master*" the CAN bus address of the DS master is set for every slave. This specifies which of the controllers coordinates/executes the defrost. The parameter "*DS-Wait time*" is ignored by the DS slave and should be set to "-". Similarly, the parameters for the defrost timer should be configured so that no additional defrosts occur on the slave if no additional defrosts are desired outside of the defrost sequence. To this end, it is recommended to set all the defrost times to "-" and the parameter "*Defrost Timer*" to "INT" (menu 3-2).

Example configuration:

1. Specify the sequence in which the controllers should defrost (e.g. first the controllers with the addresses 11 and 12, then 22, 25 and 27, then 5 and 28).
2. The controllers that defrost first belong to group 1:
 - a. For one of these controllers (e.g. address 11) under 2 Setpoints – 2 Defrost – 1 Zone 1:
 - i. Set the *DS-Function* to "Master"
 - b. For all other controllers in group 1 (e.g. UA with address 12) under 2 Setpoints – 2 Defrost – 1 Zone 1:
 - i. Set *DS-Function* to Slave and
 - ii. Set *DS-Group* to 1 and
 - iii. Set *DS-Master* to the CAN bus address of the master controller (in example "11").
3. The controllers which are to be defrosted next receive the group number 2.
 - i. For all these controllers (in example controllers 22, 25 and 27):
 1. Set *DS-Function* to Slave and
 2. Set *DS-Group* to 2 and
 3. Set *DS-Master* to the CAN bus address of the master controller (in example "11").
4. Apply the same procedure to further groups (in the example controller 5 and 28) and enter the respective group number (here group number 3).
5. If required a delay time can be set on the master controller (e.g. 11) for the period between group defrosts under 2 Setpoints – 2 Defrost – 1 Zone 1 - *DS-Wait time*.

Further measures for the parameterization of the defrost sequence

- The initiation of an additional, separate defrost (manual, external, internal, CAN) on a defrost sequence slave is to be avoided (defrost time set to "--"), however if needed it can nevertheless be carried out.
- Safe defrost times, drip and delay times and defrost on demand can be assigned individually for every controller of the consecutive chain.
- The parameter "DS Master" cannot be set to CAN bus addresses that do not exist. If the controller does not exist or is unable to execute a defrost, then the alarm "Defrost Malfunction" is generated.

Group numbers

The defrost sequence master is automatically in group 1 as it starts the defrost, and if the conditions are met, will also defrost itself in the process. The number of the group determines the defrost sequence. Numbers can also be jumped over. If one group has finished defrosting, the group with the next highest number will be automatically defrosted following the elapse of the delay time set on the master. By remaining in regular contact with the other controllers on the CAN bus, the DS master has an overview of all the DS slaves and the corresponding group numbers. The controllers must be configured so that the defrost sequence is carried out in the desired sequence.

Actual values

Under 1 Actual Values – 3 Defrost the following actual values for the defrost sequence can be found: The parameter "*DSq Nof. Sl.*" on the defrost sequence master indicates the number of slaves recognised by the master. The parameter "*DSq Lost Sl.*" On the DS master shows "lost" defrost sequence slaves: When a previously available defrost sequence slave can no longer be contacted, then the CAN bus address of the DS slave which the master first lost contact with during the last defrost is shown here. Otherwise (normal case) "-" is displayed.

Special cases / useful information

Information on the initiation of the defrost sequence

- Even if the defrost sequence master does not itself meet the defrost condition (e.g. defrost termination temperature already reached) at the time the defrost is to be initiated, the defrost of the groups is still initiated.
- Once a defrost has been initiated in master/slave operation this can only be interrupted when the parameter "*DS-Function*" is set to "OFF" for a minimum of 10 seconds and then reset to "SLAVE", see menu 2-2-1 – Defrost 1. It is generally recommended that this procedure only be employed for commissioning situations as an interruption of the defrost can result in increased icing.
- During a defrost sequence the slave's safe defrost, delay and drip times are retained, the parameters set by the user on the slave are used.

Defrost start times dependent on the number of groups and their defrost durations

The defrost start times configured in the defrost master must have sufficient time between them. It is not permitted for the defrost master to initiate a further defrost while the previous defrost is still underway. If, for example, there are 3 defrost sequence groups each with a safe defrost time of 60 minutes for the slaves, then the time period between each defrost start on the DS master must be at least 3 hours. If a DS delay time is configured between the groups, then this time is increased accordingly (in the case of n defrost groups (n-1) delay times).

Combination with the master/slave function

A defrost sequence slave can also function simultaneously as a master in a master/slave defrost via CAN bus.

-  During the initiation of the defrost sequence via an external defrost timer, the external 230 V signal, as is customary, may only be applied to the controller, in this case the master controller, for the duration of the defrost. Only when the defrosting of the master has ended - through the removal of the external signal - can the other groups begin with their defrost!

Alarms and messages

The alarm 125 „No Defrost" can also indicate that a defrost sequence has not been correctly configured.

5.5.8 Fan control with case and cold-room controllers

5.5.8.1 Fan control on multidecks

Controller type: only UA 111, UA 121, UA 111D

During cooling and defrost the fans run continuously and can be stopped for an adjustable period via the parameter Laufzeit Rollo (only with external setpoint shift from setpoint data record 1 to setpoint data record 2 (not the reverse)). This is necessary to ensure trouble-free closing of the night blind (e.g. on Light OFF). The fan relay is the normally closed (inverted) type:

- when the controller turns on the fan, then the relay contact (73/74) is opened;
- when the controller turns off the fan then the relay contact (73/74) is closed.

5.5.8.2 Fan control - Controller type UA 131

Controller type: UA 131

The functions for the fan control are activated via the DIP switch S3 on the controller circuit board, see chapter [Belegung der 230 V AC-Relaisausgänge](#). The terminal assignment, with the exception of the assignment of the 230 V relay outputs, is identical with the terminal assignment of the UA 131 (see chapter [UA 400 installation and start-up](#)).

The fan relay operates inverted: - when the controller turns on the fan, then the relay contact (73/74) is opened; - when the controller turns off the fan then the relay contact (73/74) is closed.

 When using the fan control **no** defrosting can be controlled via the relay 73/74.

Parameterization of the fan control

The relevant parameters for the fan control are found in the operator menu of the case controller under menu item 2 setpoints - 6 fan and can be used for the normal setpoint or the alternative setpoint.

Functional characteristics

The fan relay is switched on throughout the cooling. At the start of a defrost the fan relay switches off. During the defrost the fan relay remains switched off. When the defrost is completed the fan relay switches back on in the event of an undershooting of the Fan start parameter on the evaporator.

During single-zone operation only the evaporator sensor R1.1 is required to undershoot the Fan start value in order for the fan relay to be switched on.

During two-zone operation both the evaporator sensors R1.1 **and** R1.3 must undershoot the Fan start value in order for the fan relay to be switched back on. If the evaporator sensor R1.3 is not attached then the fan relay will only be controlled via R1.1, even during two-zone operation. In order for the fan to remain switched on during cooling and defrosting (continuous operation), the Fan start value must be set to "-".

5.5.8.3 Fan control - controller type UA 131 LS with enhanced fan control

Controller type: only UA 131 LS with enhanced fan control

The enhanced functions for the fan control must be activated via the DIP switch S3 (5=ON) on the circuit board of the case controller.

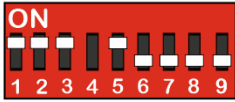

Apart from the terminal assignment of the 230 V relay outputs, the terminal assignment is identical to the terminal assignment of the UA 131 (see [chapter Belegung der Analogeingänge für Temperaturfühler](#)).

The fan relay operates inverted:

- if the controller switches on the fan, the relay contact (15/16) is closed;
- if the controller switches off the fan, the relay contact (15/16) is opened.

⚠ When using the fan control, **no** alarm signalling via the 230 V alarm relay can be performed. However, the 24 V DC output at the terminals 81 / 82 / 83 can be used for alarm signalling.

Parametrisation of the enhanced fan control

The relevant parameters for the fan control are in the Operation menu of the case controller under menu 2 Setpoints - 6 Fans and can be used for the normal setpoint and the alternative setpoint. The desired operating mode must first be selected for the fan control. This is done via the parameter *BetrArt*.

The following four parameters are available for the operating mode:

- *DAUERLAUF* (continuous operation)
- *VORLAUF* (flow)
- *NACHLAUF* (overrun)
- *VERZ.N.ABT.* (delay after defrost)

The two parameters *Lüfterverzöger* and *Lüfter Über* are used for control of the fans via the temperature at the evaporator sensors R1.1 and R1.3. These parameters are not effective in all operating modes.

Function description of the 4 operating modes

1. Operating mode "continuous operation"

The fan relay is always switched on in this operating mode.

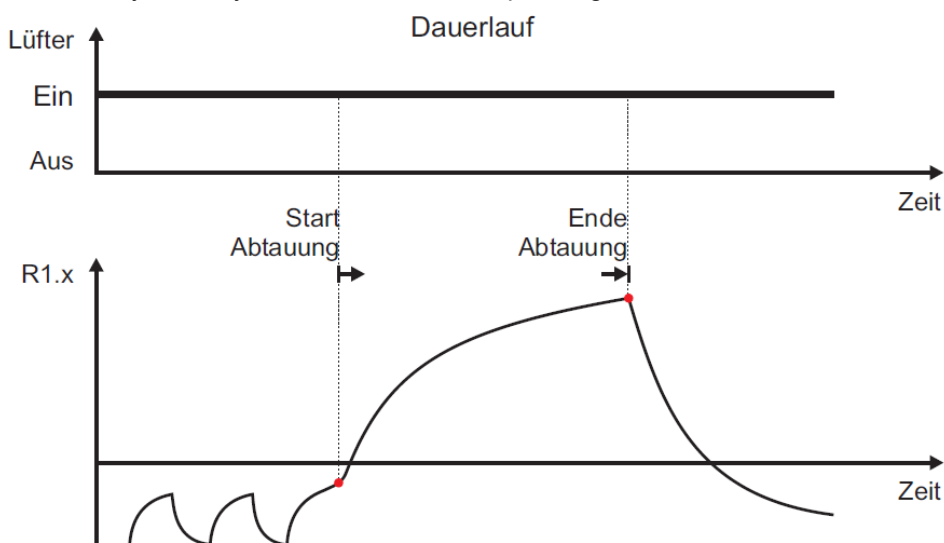

ZNR. 103 030 D0

i The two parameters *Lüfteranlauf* and *Lüfter Über* have no effect in this operating mode.

2. Operating mode "flow"

The fan relay is switched on continuously during the cooling in this operating mode.

The fan relay switches off at the start of a defrost. The fan relay switches on if the parameter *Lüfter Über* at the evaporator sensor is exceeded.

When the defrost is complete, the fan relay is switched on again in all cases.

Only the evaporator sensor R1.1 is used for fan control in single-zone operation. Both evaporator sensors R1.1 **and** R1.3 are used for fan control in two-zone operation. If the evaporator sensor R1.3 is not attached, then only the evaporator sensor R1.1 is also used for fan control in two-zone operation.

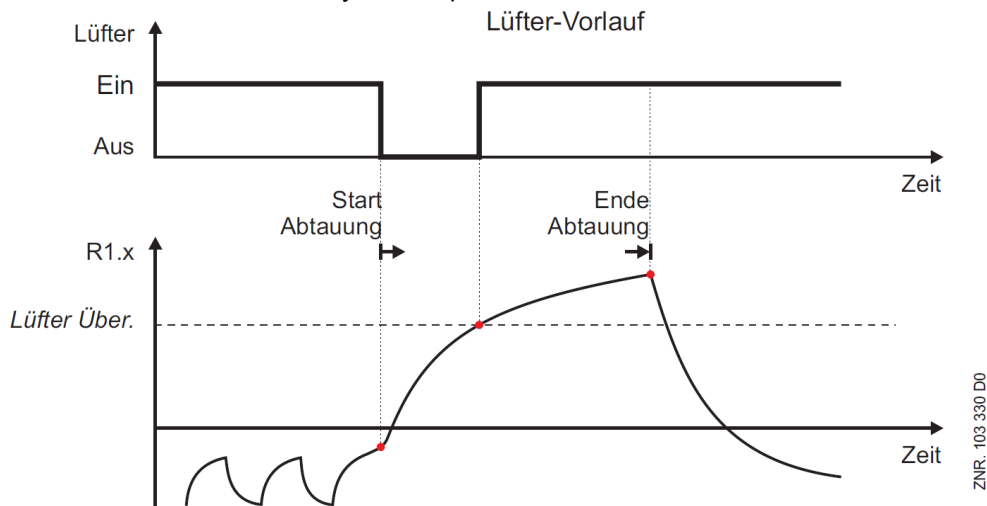

i The fan relay does not change its state during any possibly parametrised drip time. The parameter *Lüfter Über* is already evaluated during a possibly parametrised wait time. The parameter *Lüfterverzöger* has no effect in this operating mode.

3. Operating mode "overrun"

The fan relay is switched on continuously during the cooling in this operating mode.

The fan relay initially remains switched on when defrosting starts. The fan relay switches off if the parameter *Lüfter Über* at the evaporator sensor is exceeded. When the defrost is complete, the fan relay is switched on again if the parameter *Lüfterverzöger* is undercut again at the evaporator.

Only the evaporator sensor R1.1 is used for fan control in single-zone operation.

Both evaporator sensors R1.1 and R1.3 are used for fan control in two-zone operation. If the evaporator sensor R1.3 is not attached, then only the evaporator sensor R1.1 is also used for fan control in two-zone operation.

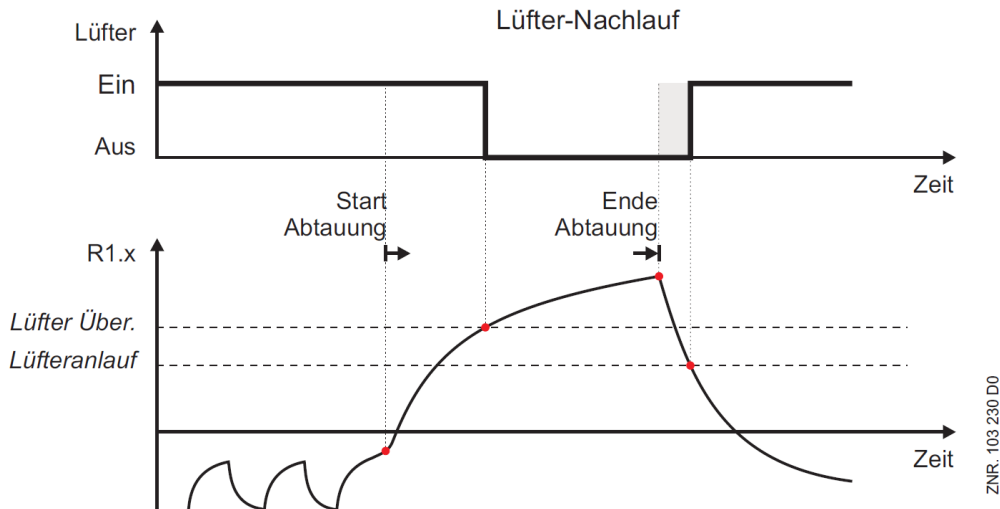

- i** The fan relay does not change its state during any possibly parametrised drip time. The parameter *Lüfter Über* is already evaluated during a possibly parametrised wait time.

4. "Delay after the defrost" operating mode

The fan relay is switched on continuously during the cooling in this operating mode. The fan relay switches off at the start of a defrost. The fan relay remains switched off during the defrost. When the defrost is finished, the fan relay switches on again if the parameter *Lüfterverzöger* on the evaporator is undercut again.

In single-zone operation, only the evaporator sensor R1.1 has to fall below the value of *Lüfterverzöger* so that the fan relay is switched on.

In two-zone operation, both evaporator sensors R1.1 **and** R1.3 must fall below the value of *Lüfterverzöger* so that the fan relay is switched on again. If the evaporator sensor R1.3 is not attached, then the fan relay is also only controlled via R1.1 in two-zone operation.

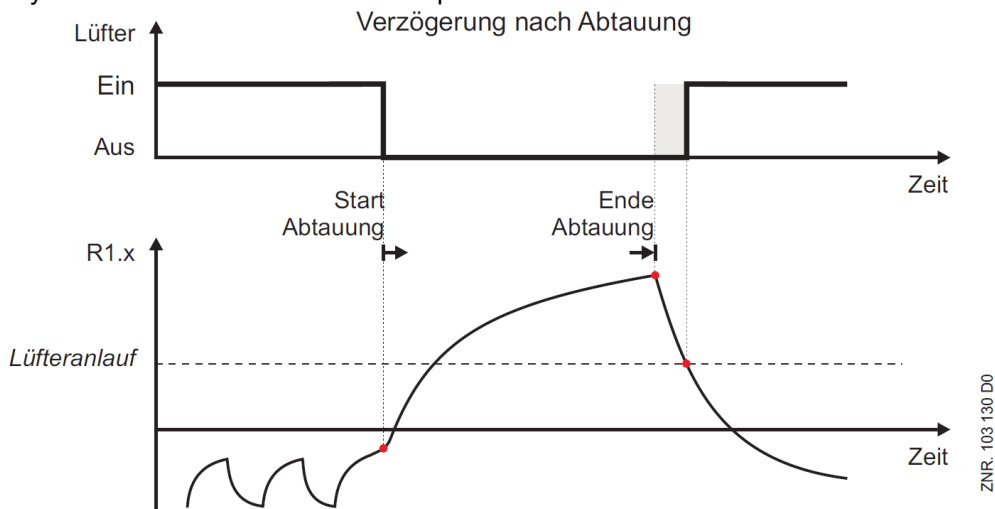

- i The fan relay is switched off during any possibly parametrised wait or drip time. The parameter *Lüfter Über* has no effect in this operating mode.

5.5.8.4 Fan control - Controller type UA 131 DD

Fan control works with the first defrost sensor of a zone and a relay.

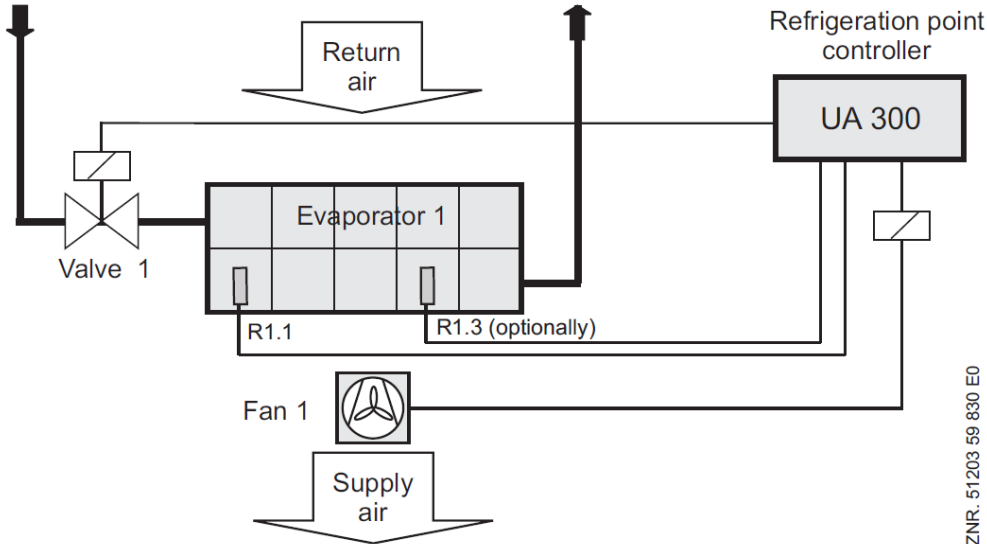

R1.1: Evaporator sensor

R1.3: Evaporator sensor (optional in two-zone operation)

Fan 1: Fan control relay

The fan continues running during cooling and is stopped during defrosting. With external toggling of setpoints from Set 1 to Set 2 - but not vice versa - the fans stop for a definable time. This is necessary to ensure trouble-free closing of the night blind (e.g. on Light OFF).

If a thermal fan delay has been set, the fan is initially not switched on after the defrosting in order not to blow any heat into the display case. The fan relay is the normally closed (inverted) type:

- the relay contact (15/16) is open when the controller switches on the fan;
- the relay contact (15/16) is closed when the controller switches off the fan.

Fan relay: inverted activation

Single-zone: R1.1 acts on fan relay

Two-zone: R1.1 and R1.3 acts on fan relay

5.5.8.5 Fan control - Controller type UA 141 E

The case controller does not contain any fan control for this controller type.

5.5.9 Fan control with cold-room controllers

The fan control differs in single zone and two zone operation.

Single-zone operation

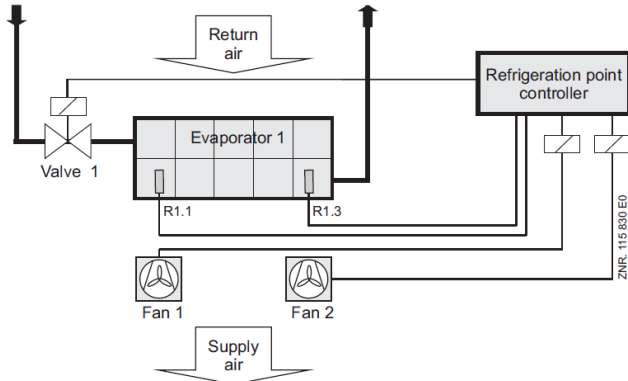

- R1.1: Evaporator sensor
- R1.3: Evaporator sensor (optional)
- Fan 1: Fan control relay 1
- Fan 2: Fan control relay 2 (optional)

Two-zone operation

In two-zone operation, evaporator sensor sensors R1.1 and R1.3 and the fan control relays each act separately on one zone.

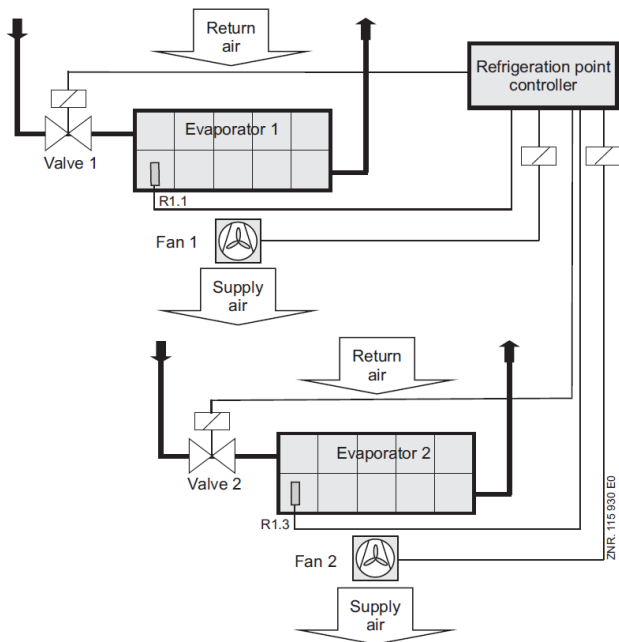

- R1.1: Evaporator sensor zone 1
- R1.3: Evaporator sensor (optional) zone 2
- Fan 1: Fan control relay 1 zone 1
- Fan 2: Fan control relay 2 (optional) zone 2

5.5.9.1 Cold-room with defrost heater - Controller type UR 141 TK (LT) only

Parameters for fan control on the UR 141 TK (LT) are as follows:

- Fan time delay (fan lead time, as standard set to 0 minutes)
- Thermal fan delay

The fan starts running when cooling is started. If cooling is stopped during cooling mode, e.g. due to exceeding the setpoint and dead band, the fan is also stopped (time-controlled fan delay set to 0). This is the case when the fan time delay (parameter *Fan forerun.*, menu 6-3) is set to 0 minutes.

If a thermal fan delay has been set (parameter *Fan forerun.*, menu 2-3-1...2-3-4), the fan is not turned on immediately following defrosting in order to avoid blowing warm air into the cold room. If the setpoint and hysteresis are exceeded on the cold-room air sensor during cooling mode and time-controlled fan delay is set greater than 0, only the fan will be started initially and cooling will not be started.

The purpose of this is to transfer any cold remaining in the evaporator to the cold-room and to remove any stratification of warm and cold air layers in the room. Cooling is not started until setpoint and hysteresis are still exceeded on the room air sensor following expiration of the time-controlled fan delay.

The fan is stopped during defrosting. If a waiting time has been defined (parameter *Wait Time*, Menu 2-2-1...2-2-4), the fans that are running will not be stopped before initiating defrost until the set waiting time has expired. This allows the refrigerant remaining in the evaporator when the solenoid valves are closed to evaporate.

Application examples for fan control with cold room controllers:

Example 1: Thermal fan delay - factory setting

Fan time delay deactivated (parameter *Fan forerun* set to 0 minutes, menu 6-3) Thermal fan delay = 0 °C (parameter *Fan Delay*, menu 2-3-1...2-3-4)

The fan switches on and off again with the cooling. In the event of defrosting the fan is switched off. Following defrosting the fan is switched on as soon as the evaporator sensor registers a temperature below 0 °C.

Example 2: Energy-optimized operation

Fan time delay activated (parameter *Fan forerun* set to 2 minutes, menu 6-3) Thermal fan delay = 0 °C (parameter *Fan Delay*, menu 2-3-1...2-3-4)

The fan switches off with the cooling. If refrigeration is required again, then the fan is switched on for the programmed lead time (here 2 min.), then the cooling. In the event of defrosting the fan is switched off. Following defrosting the fan is switched on as soon as the evaporator sensor registers a temperature below 0 °C.

Example 3: Fan time delay

Fan time delay activated (parameter *Fan forerun* set to 2 minutes, menu 6-3) Thermal fan delay = – (parameter *Fan Delay*, menu 2-3-1...2-3-4)

The fan switches off with the cooling. If refrigeration is required, then the fan is switched on for the programmed lead time (here 2 min.), then the cooling. In the event of defrosting the fan is switched off.

Example 4: All fan delays inoperative

Fan time delay deactivated (parameter *Fan forerun* set to 0 minutes, menu 6-3) Thermal fan delay = – (parameter *Fan Delay*, menu 2-3-1...2-3-4)

The fan switches on and off again with the cooling. In the event of defrosting the fan is switched off.

5.5.9.2 Cold-room without defrost heater - Controller type UR 141 NK (NT) only

As a rule the fan continues running during cooling and defrosting. When the *Overrun Time* parameter is set greater than 0 minutes and the *Fan Overrun* (see menu 2-3-1) parameter is set other than to "--", the fan starts simultaneously with cooling and stops after a delay when cooling is stopped. The fan stop delay is dependent on two conditions, both of which must be satisfied:

- The set time-controlled fan delay (parameter *Fan Delay*) must have expired.
- The set thermal fan delay (parameter *Fan Overrun*) of the fans must be obtained or exceeded on the evaporator sensor.

Example 1: Energy-optimized operation - latent heat utilization - factory settings

Thermal fan delay deactivated (parameter *Fan Overrun* set to --, menu 2-3-1..2-3-4) Fan time delay = 0 min. (parameter *Overrun Time*, menu 2-3-1...2-3-4)

Case 1: If the time delay is exceeded during cooling operation after switching off the cooling relay and the evaporator sensor $< t_{Fan}$, the fan continues to run until the evaporator sensor reaches the set temperature.

The fan continues running during defrosting

Case 2: If the evaporator sensor temperature is already greater than t_{Fan} during cooling operation after switching off the cooling relay **and** the delay time has not expired, the fan continues to run **until** expiry of the delay time. The fan continues running during defrosting

Example 2: All fan delays inoperative

Thermal fan delay deactivated (parameter *Fan Overrun* set to --, menu 2-3-1..2-3-4) Fan time delay = 0 min. (parameter *Overrun Time*, menu 2-3-1...2-3-4)

During cooling and defrosting the ventilator runs without interruption (continuous operation).

5.5.9.3 Heating circuit (controller type UR 141 TK (LT) or NK (NT) only)

Fan control changes as follows: Zone 1 fan always starts together with the heater relay. If the temperature on R1.1 is higher than the fan delay temperature, the Zone 1 fan will stop with the heater relay. The starting conditions stated above apply equally to this condition, meaning that the fan will start when at least one of these conditions is satisfied. The fan relay is the normally open type. The fan relay operates according to the normally open principle (relay is activated, normally open contact closes).

5.6 Humidification - Controller type UA 141 only

A humidifier can be controlled as an alternative to the 2nd temperature zone. This requires that the 2nd temperature zone has not been selected. Only then can a setpoint be entered for humidifier on time. The humidifier will then be operated for the set time every time cooling is stopped. If cooling restarts before the set interval has expired, the humidifier will continue running for not more than 90 seconds.

5.7 Antisweat heaters

General

The frame and pane heaters are used to heat glass pane elements on refrigerated display cases so as to prevent them from fogging due to condensation of moisture from the ambient air. The Case Controller enables selection among three operating modes for these antisweat heaters:

- Fixed on time
- Setpoint-controlled on time (UA 131 only)
- Enthalpy-controlled on time

The operating mode wanted must first be selected. Additional parameters for the respective mode are described below.

Timing relay function for service counters (controller type UA 141 only)

A voltage pulse applied (e.g. by on-site pushbutton switch, min. 6 sec.) to the 230 V digital input for the frame heater causes the corresponding relay of the Case Controller to energize and subsequently de-energize after completion of the set pane heater on time. The same 230 V digital input is otherwise usable for manual shutdown, in which case the timing relay function will not be available.

Control by on time

As an alternative to the method described below for control as a function of cooling setpoints, the frame heater can be set to operate intermittently with an adjustable on time (0 to 100%). The full time interval is 10 minutes, meaning that the frame heater will be ON for 1 minute and OFF for 9 minutes when set to 10%.

Control as a function of cooling setpoint (controller type UA 131, UA 131 DD only)

As an alternative to the method described above for control by on time, the frame heater can be controlled as a function of working mode (supply air or return air mode) and the setpoint entered for the first temperature zone, as shown below:

- Return air mode
 - Return air setpoint $\geq -18^{\circ}\text{C}$, heating 40% ON
 - Return air setpoint $> -20^{\circ}\text{C}$, heating 50% ON
 - Return air setpoint $< -20^{\circ}\text{C}$, heating 60% ON
- Supply air mode
 - Supply air setpoint $\geq -32^{\circ}\text{C}$, heating 75% ON
 - Supply air setpoint $< -32^{\circ}\text{C}$, heating 95% ON

These percentage on rates mean that with a defined interval of 10 minutes the frame heater will be ON for 4, 5, 6, 7.5 or 9.5 minutes respectively. The frame heater is off during defrosting.

Operation of transistor output (91/92) for frame heater (controller types UA 111, UA 111 D, UA 121, UA 131, UA 131 DD, UR 141 NK (NT), UR 141 TK (LT))

Operation is inverted (factory setting). The transistor output (91/92) delivers a signal of 0 V when the frame heater is ON and 24 V / 50 mA when the frame heater is OFF. The function can be configured via the parameter „Invert Output“ (menu 2-5-2).

Operation of pane heater relay (controller type UA 141)

The relay (73/74) is closed when the pane heater is ON and is open when the pane heater is OFF.

Enthalpy-controlled on time

This operating mode requires the pack controller installed in the E*LDS system to be fitted with a humidity sensor and temperature sensor for the ambient room air. The case controller then continuously determines the optimum heater on time from these two measurements. Two parameters are used, emergency on time and offset for enthalpy-controlled frame heater.

The value entered for the Enthalp. Offs. parameter (Menu 2-5-2) is added to the on time calculated by the case controller as a function of room air humidity and temperature. The default setting of zero should be retained initially. If problems are observed, for instance fogging of glass pane elements, the setting can then be adjusted upwards to obtain a higher heating capacity.

If reception of ambient humidity and temperature signals from the pack controller is interrupted, the case controller will use the emergency on time setting (0-100%) as the on time.

Notes and limitations when using enthalpy-controlled heater

A minimum of one pack controlled fitted with ambient air humidity and temperature sensors must be installed in the store. If more than one pack controller is fitted with these sensors, the case controller will select one pack controller at new start/restart and then work only with the values transmitted by that pack controller.

-  We recommend equipping only one pack controller in the store with ambient air humidity and temperature sensor. These sensors should be mounted at locations that will ensure the humidity and temperature measurements supplied are as representative as possible for all refrigeration points in the store.
- Trouble-free operation is not ensured if only a temperature sensor or a humidity sensor is connected to a pack controller. The two sensors must always be connected as a pair to the same pack controller.

Failure of pack controller/CAN bus when using enthalpy-controlled heater

If the case controller does not receive ambient air temperature and humidity signals from the pack controller over a period of 10 minutes, it will automatically switch to the set emergency on time.

Timing relay function for service counters (controller type UA 141)

-  The timing relay function can be activated via digital Input 1 (terminals D11 and D12). This requires digital Input 3 to be set as PANE ACTU. for the switch on/off function to be available.

Via a voltage pulse applied (e.g. by on-site pushbutton switch, min. 10 sec.) to the digital input 3 for the frame heater (terminal D31/D32, (factory setting). causes the corresponding relay of the Case Controller to energize and subsequently de-energize after completion of the set pane heater on time.

This function is available on the UA 141 supplementary to the fixed on time or enthalpy-controlled on time functions. To ensure compatibility with earlier software versions, a fixed on time of 0% is set on the UA 141 at first start, meaning that the pane heater is then controlled exclusively by the timing relay function. The function of the digital input can be configured via the parameter „Inv. D3" (i.e. Inv. D2) in menu 6-2-4.

On time interval

The full time interval for the frame and pane heater is 10 minutes, meaning that the frame heater will be ON for 1 minute and OFF for 9 minutes when set to 10%.

Defrosting

The frame heater is off during defrosting. With the UA 131 the frame heater is always switched off during defrosting. The frame heater is switched off according to the status of the first defrost zone. With other controller types, not the UA 131, the frame heater is not switched off during defrosting.

5.8 Automatic on/off control

Controller type: UA 141 only

The counter can be switched on and off by a voltage pulse (on-site push button switch, min. 6 sec.) at the 230 V AC counter shutdown digital input. As with manual shutdown, all controlled functions are switched off. The function of the digital input can be configured via the parameter „Inv. D3" (i.e. Inv. D2) in menu 6-2-4.

Additionally, electrical loads on the counter that are not controlled, e.g. lighting, fans and frame heaters, can be switched on and off through an external relay at the transistor output (terminals 91/92/93).

⚠ Warning - hazardous electrical voltage! Danger of electric shock! BEFORE connecting and disconnecting it must be checked that the 230 V AC digital inputs are **off load!** The controller and connected voltage carrying components remain supplied with power!

i Counter shutdown can be activated via digital Input 2 (terminals D21/D22, factory setting). This requires digital Input 2 to be set as AUTO ACTU. for the switch on/off function to be available.

Switch-on:

Up to 7 control times for automatic restarting of the counter can be set on an internal timer. The same 230 V input is usable as an external input for setpoint toggling, in which case the on-off function will not be available. The counter is switched on either by a voltage pulse applied to digital Input 2 or by the control times. The transistor output (terminals 91/92/93) is set to 24 V / 50 mA.

i Parameters of the internal restart time are displayed and can be adjusted when setpoint toggle is set to "INT" or "---" (see Screen 3-3 in the UA 141 menu structure).

Switch-off:

As with manual shutdown, all controlled functions are switched off by the voltage pulse applied to digital Input 2 (terminals D21/D22). The transistor output (terminals 91/92/93) is set to 0 V.

5.9 Door contact

Controller types UR 141 NK (NT) and UR 141 TK (LT) only

With coldrooms, one or two 230 V AC digital inputs (terminals D21/D22 and D31/32, factory setting) can each be allocated as a cold-room door contact. Cooling and the evaporator fan are switched off when the cold-room door is opened.

In the event of a permanently open door, an alarm is activated and the controller returns to cooling following the elapse of the adjustable alarm delay time.

 **Warning - hazardous electrical voltage! Danger of electric shock! BEFORE** connecting and disconnecting it must be checked that the 230 V AC digital inputs are **off load!** The controller and connected voltage carrying components remain supplied with power!

 Door Contact 1 can be activated via the digital input 3 (terminal D31/32). This requires Digital Input 3 to be set as *DOOR CONTACT* (Menu 6-2-4) for the door contact to be available. Door Contact 2 can be activated via Digital Input 2 (terminals D21/D22). This requires Input 3 to be set as *DOOR CONTACT* for the door contact to be available. The function of the two digital inputs can be configured via the parameter *Inv. D2* (i.e. *Inv. D3*) in menu 6-2-4. If the alarm delay is set to 0 minutes then the cooling and the evaporator fan are not switched off and the alarm is immediately discharged.

Conditions for switch-off

If the high temperature alarm setpoint (on cold-room sensor) is exceeded or if maximum door open time expires, cooling and the evaporator fan will be restarted before the door closes. High cold-room air temperature (high temperature alarm) also inhibits switch-off.

If the controller is operated with two zones and only the first 230 V digital input (Door Contact 1) is configured for cold-room door monitoring, the door contact switch will stop cooling and the evaporator fan in both zones. The same applies when only the second 230 V digital input is configured on Door Contact 2.

In single-zone operation the door contacts always act on first zone control. The only exception is when both 230 V digital inputs are set to door contact function, in which instance Door Contact 1 alone acts on control and Door Contact 2 has no function.

 No archiving takes place in the internal archive memory for the second door contact.

5.10 Manual shutdown

A voltage present at the 230 V input for the manual shutdown switches off all control functions (cooling, defrost,...) and the alarming (e.g. [Registration of external alarms](#)). However all interfaces and operating functions remain active.

⚠ Warning about dangerous electrical voltage!
Danger of electric shock! BEFORE connecting and disconnecting, it must be checked that **no voltage is present** at the 230 V AC digital inputs! The controller and connected voltage carrying components remain supplied with power!

All controller types

i The manual shutdown can be activated using all the digital inputs. The corresponding input must be parametrised as *HANDABSCH* (Menu 6-2-4) for this. The manual shutdown is not available until then. A manual shutdown via the digital inputs can also be performed separately for zone 1 and zone 2. This requires one digital input to be parametrised as *HANDABSCH.Z1* or *HANDABSCH.Z2* respectively. The function of the two digital inputs can be configured via the parameters *Inv. D1* to *Inv. D4* in menu 6-2-4. If multiple digital inputs should be configured with the same function, this function becomes active as soon as a signal is applied to one of these inputs. The same 230 V input can also be used as input for the pane heater or door contact for controller type UA 141 or UR 141 NK/TK. However, the function "Manual Shutdown" is then no longer available.

5.11 Registration of external alarms (e.g. CO₂ alarm)

A voltage applied at the 230 V AC input serves to register external alarms e.g. CO₂ alarms. The message text (CO₂ alarm, factory setting) can be freely entered in menu 6-2-4 (also with the BT 300).

⚠ Warning – hazardous electrical voltage! Danger of electric shock! BEFORE connecting and disconnecting it must be checked that the 230 V AC digital inputs are **off load!** The controller and connected voltage carrying components remain supplied with power!

i The external alarm can be activated via digital input 4 (terminals D41/D42). If the digital input is used for the monitoring of e.g. a CO₂ alarm, then for safety reasons its function should be inverted to "ON" via the parameter *Inv. D4* (menu 6-2-4).

5.12 Emergency power operation

Function

The aim of the emergency power operation is, in the event of an interruption in the power supply, to provide intelligent support for the emergency power supplied via an emergency generating unit. The LDS components are designed to prevent unnecessary power consumption which could endanger the emergency power supply. If the allocated pack controller detects an interruption in the power supply then this is transmitted to the case controllers via the CAN bus. In combination with the emergency power operation functions, the case controllers can block control functions as required. This serves to reduce the load on the emergency generating unit.

Activation of emergency power operation

The participation of the case controllers in the emergency power operation can be set individually. To do this it is necessary to specify the allocated pack controller via menu item 6-1 on the case controller. This pack controller must support emergency power operation and be parameterized accordingly in order for it to dispatch an emergency power message (see the pack controller operating instruction).

The behaviour of the case controller in emergency power operation can be set using the following parameters in menu 6-6:

- Cooling functionality Parameter Cool.funct.OFF
- Defrost functionality Parameter Defr.funct.OFF
- Fan functionality Parameter Fan funct. OFF
- Frame heating functionality Parameter Frame fct.OFF
- Light functionality Parameter Light fct.OFF

If, for example, the case controller is required to switch off the cooling on receiving an emergency power message, then the parameter *Cool.funct.OFF* must be set to Y (Yes). If this parameter is set to N (No), then the case controller continues cooling even during emergency power operation.

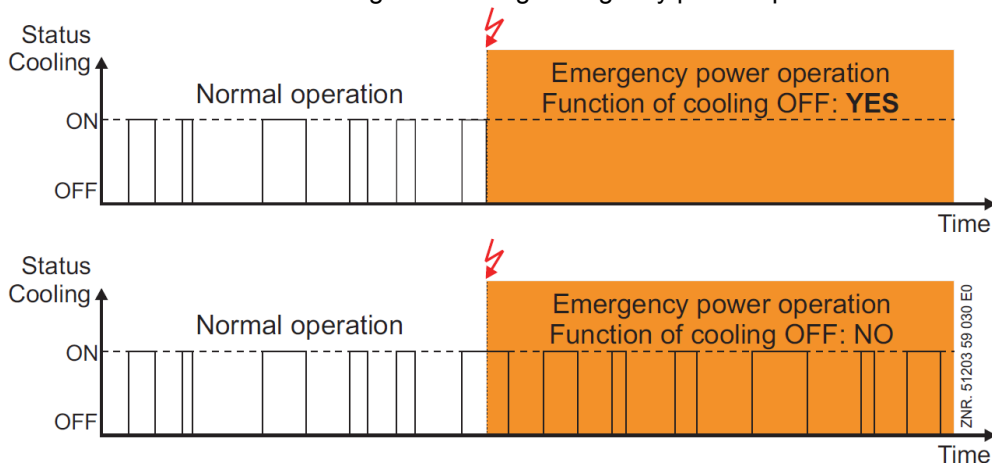

All other parameters in principle function the same. They determine whether the defrosting or the fan is switched off during emergency power operation. If the controller is conducting a defrost at the start of emergency power operation then the defrost is immediately interrupted. If the defrost command comes during emergency power operation then the command is ignored.

- i** Defrosts that are ignored or interrupted due to emergency power operation are not automatically repeated by the controller. If a defrost interruption occurs due to emergency power operation then the refrigeration capacity of the corresponding refrigeration points must be checked.

5.13 Setpoint toggle (day / night operation)

Controller setpoints can be entered double as a standard value and an alternative value. Setpoint toggle allows changing between these two values. Setpoint toggling can be made in two ways:

- **External:** By voltage applied to 230 V- Digital Input 2 (Terminal D21/D22, factory setting) by a switch or timer. Alternatively, with an appropriate parameterization of the digital inputs (menu 6-2-4), the setpoint switch can be carried out via digital input 1 (terminals D11/D12) or digital input 4 (terminals D41/D42). The function of the digital inputs can be configured via the parameters *Inv. D1 to Inv. D4* (menu 6-2-4). If more than one input has been parameterized with the same function, then this function is active as soon as a signal is applied to one of these inputs.

 **Warning - hazardous electrical voltage!**

Danger of electric shock! BEFORE connecting and disconnecting it must be checked that the 230 V AC digital inputs are **off load!** The controller and connected voltage carrying components remain supplied with power!

- **Internal:** By setting toggle times on the internal clock. (only active when the parameter *Toggle interv.* (Menu 3-3) is set to "--").
- **CAN bus:** With the use of a system centre or a suitable store computer (version 4.24 or higher) the setpoint can also be controlled from the system centre / store computer via CAN bus. Further information on setpoint switching can be found in the system centre's / store computer's documentation in the chapter "Special Inputs".

UA 111, UA 111 D, UA 121:

The fan stops for an adjustable time (night blind close time). The fan restarts when toggling back from alternative to standard setpoints.

Night blind run time

-  **Night blind close time** As a rule, the night blind is closed on refrigerated multidecks when toggling setpoints. Some cases require the fans to be stopped while the night blind is being closed to prevent it from being forced out of the case.

UA 141, UR 141 TK (LT), UR 141 NK (NT)

-  Setpoint toggle can be activated via digital Input 2 (terminals D21 and D22). This requires digital Input 2 to be set as SETP.TOGGLE (Menu 6-2-4) for external setpoint toggle to be available.

5.14 Light control

The case controller is equipped for activating the case lighting / night blind. Activation is carried out via the 24 V digital output (terminals 81/82). The on/off command is issued by a higher order controller (e.g. system centre / store computer / PLC) via the CAN Bus. The parameterization is carried out on the higher order controller, the case controller doesn't require parameterization. The condition of the output is displayed in the menu 1-2 ("Status light ON/OFF").

 The higher order controller must support this function.

5.15 Refrigeration point disabling

The Case Controller provides the option of initiating refrigeration point disable via CAN bus for the pack controller (e.g. VS 3010). Cooling is interrupted as long as refrigeration point disabling is active.

5.16 Forced cooling

The Case Controller provides the option of initiating forced cooling via CAN bus for the pack controller (e.g. VS3010). The Case Controller switches to continuous cooling as long as forced cooling is active. During a forced cooling the delay time for the low temperature alarm is reset in order to prevent a false alarm during the forced cooling operation.

5.17 Operating data archiving

5.17.1 Temperature recording

Temperature recording is provided only for systems that do not have higher-order temperature recording (e.g. by system centre / store computer). Temperatures measured on the return air/cold-room air sensors of both temperature zones and the status of alarm, cooling, defrosting, manual shutdown and cold-room door are recorded at intervals of 15 minutes and stored in ring buffer memory over a period of one year.

 This data recording does not meet the requirements of EU Regulation 37/2005 on the monitoring of temperatures in means of transport, warehousing and storage of quick-frozen foodstuffs intended for human consumption.

Local temperature recording on system centre / store computer

The Case Controller records temperature at 15 minute intervals and transmits the data via CAN bus to the system centre / store computer for archiving.

Temperature recording in stand-alone operation (local) (only UA 400 AC / UA 410 AC)

Temperatures are recorded at 15 minute intervals and stored in the flash memory of the Case Controller. The recorded data can be displayed on the local BT 300 x Operator Interface under Archive (Menu 5) or can be read out to a PC via the CI 320 port. For reading off via PC a TTY converter (accessory) is required, see LDSWin operating instruction.

Recording time

Recording	In CI 3000 store computer via CAN bus	Stand-alone operation	Length of protocol
Actual value archive of the statuses (can only be read off via LDSWin)	every 2 minutes	–	1 week
Actual value archive of all connected temperature sensors with sensor scan (max. 10, can only be read off via LDSWin)	every 5 minutes		
Archiving or EU archiving (see chapter 4.17.2) of two temperature sensors: Return air from zones 1 and 2, plus selected statuses	every 15 minutes		1 year
Local archiving in case controller of two temperature sensors: Return air from zones 1 and 2, plus selected statuses	–	every 15 minutes	
Run time / pulsing / frame heater	every 24 hours	–	

5.17.2 Temperature recording to EU Regulation 37/2005

Temperature recording in compliance with EU Regulation 37/2005 on the monitoring of temperatures in means of transport, warehousing and storage of quick-frozen foodstuffs intended for human consumption requires the use of a separate temperature recorder, e.g. UA 300 L / UA 410 L, see UA 300 L / UA 410 L operating instruction.

Operation at the LDS1 System

When operating the Case/Cold-room Controller in the earlier LDS1 System, communication takes place via the TTY interface.

Sending setpoints and actual values

The Case/Cold-room Controller supports the earlier LDS System's "short" and "long" protocol for data transmission. Attachment in the long telegram depends on the controller type selected. Setpoints and actual values not covered by the earlier system are not transmitted.

Setpoint adjustment

Setpoint adjustment of the earlier LDS1 System is not provided, as space is available in the telegrams for only a small part of the setpoints.

5.17.3 Recording of messages and alarms

In fault conditions, a maximum of 25 messages and alarms generated by the Case/Cold-room Controller is stored in a ring buffer with fault text, date/time of alarm start and date/time of alarm start end.

5.18 BT 30 temperature display

Up to 4 BT 30 temperature displays can be connected to the case controller.



The connection is made via the connection DISPLAY (terminals 1..6) using an RJ45 splitter.

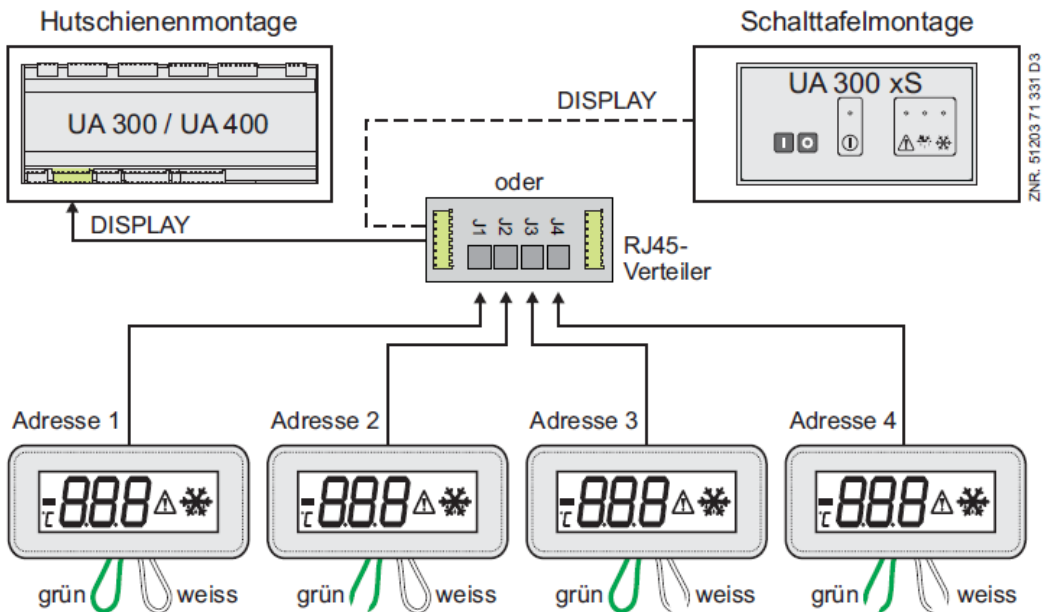

The following temperatures of a case controller or controller type can be displayed:

Controller type	Display of temperatures on the BT 30 in °C			
	Address 1	Address 2	Address 3	Address 4
UA 121 / UA 131 / UA 131 DD / UR 141 NK / UR 141 TK	R4.1	R4.2	R4.3	R4.4
UA 111 / UA 111 D / UA 141	R2.1	R2.2	R2.3	R2.4
Wire loop - BT 30 configuration				
green wire	closed	open	closed	open
white wire	closed	closed	open	open





i **Before** the connection to the case controller, all participating BT 30 temperature displays **must** be addressed using the two lead-out wire jumpers.

Practical tip: If all four BT 30 are configured the same (e.g. all wire jumpers closed = address 1), all BT 30 display the same temperature.

Further information and connection notes for the BT 30 can be found in the [operating manual of the BT 30](#).

Symbols and parametrisation

In addition to the temperature, the current status of the controller and the cooling is displayed using symbols.

	<p>Display of the current temperature: The temperature values in the temperature display can be impacted with a correction value (parameter "Offset", see Menu 6-2-2) in order to be able to compensate for differences between thermometers in the refrigerated case and in the display of the case controller.</p> <p>Note: This correction value only concerns the display; the actually measured temperatures are not corrected. This correction value has no influence on the regulation (cooling, defrost etc.).</p>
	<p>Symbol "Defrost": A defrost symbol is displayed during the defrost. The last measured temperature value is shown in the display for the duration of the defrost. This also applies during any possibly set wait time. The current temperature is not displayed again until 15 minutes after the end of the defrost. The drip time does not extend this delay time of 15 minutes.</p>
	<p>Symbol "Snowflake": Controller in cooling operation (cooling in zone 1 and/or zone 2 active)</p>
	<p>Symbol "Alarm": An alarm is pending!</p> <p>In order to counteract any uncertainty on the part of the public, the parameter "Alarmsymbol" (menu 6-2-2) can be used to activate or deactivate the display of the alarm symbol.</p>

6 UA 400 installation and start-up

⚠ Important safety instructions! Before the installation and commissioning of the controller, the chapter [Safety instructions](#) must be carefully read in its entirety and all safety instructions and hazard warnings observed.

ⓘ The controller should only be used with compatible versions of the LDSWin PC software, otherwise the scope of functions can be restricted.

Tip: The latest version of [LDSWin](#) should be used at all times.

6.1 Installation

The case controller is available in the models UA 400 CC / UA 400 AC

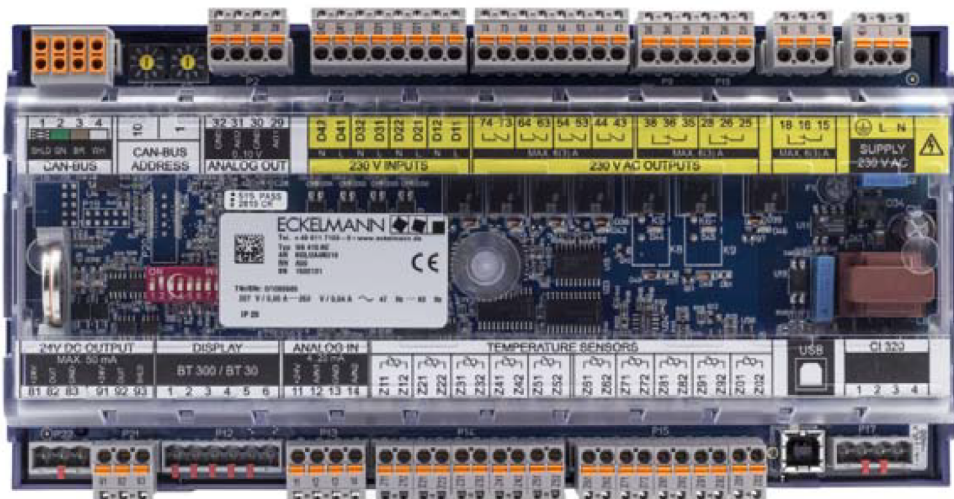

Further details about the distinguishing features of the controller types are explained in chapter [Controller types](#).

6.1.1 DIN rail mounting of the case/cold-room controller

i The power loss of the device is approx. 11 VA and must be taken into account for the installation.

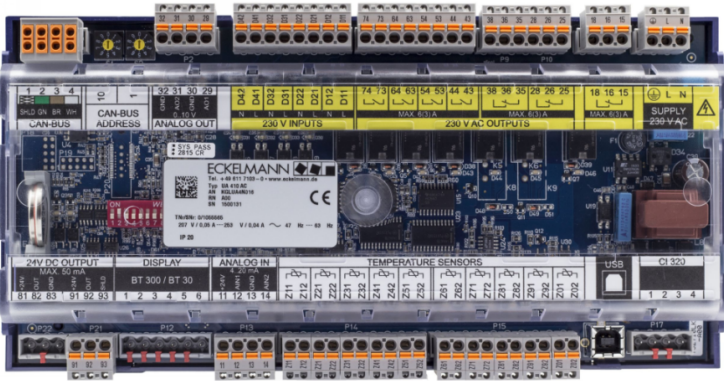

Similar to illustration

The case controller is attached to the DIN rail (35 mm) using two retaining springs. The DIN rail must have a minimum height of 5 mm.

⚠ The case controller may only be mounted on a Cap (DIN) rail and operated as an integrated regulation and control device (EN60730). All leads running to and from the case controller - especially those of the CAN bus - must be shielded (cable type: LiYCY)! No shielding is required on sensor leads when installed exclusively inside the refrigerated display case and when external interference (for example from parallel power wires) is not to be expected (see operating instruction "Introduction, General Safety and Connection Instructions"). As a general rule, care should be taken to ensure that signal leads and leads carrying a supply voltage are routed through separate cable channels.

i Electrical enclosure and dimensions are listed in Section [Specifications of UA 400](#).

6.1.1.1 Mounting on the DIN rail

⚠ Warning about dangerous electrical voltage! Danger of electric shock! The safety instructions and work safety instructions **must** be observed for the mounting. **All** plug connectors may only be inserted and removed when the power supply is disconnected.

Step 1: The two retaining springs on the underside of the device must be pulled out using a flat-blade screwdriver until they click into place.

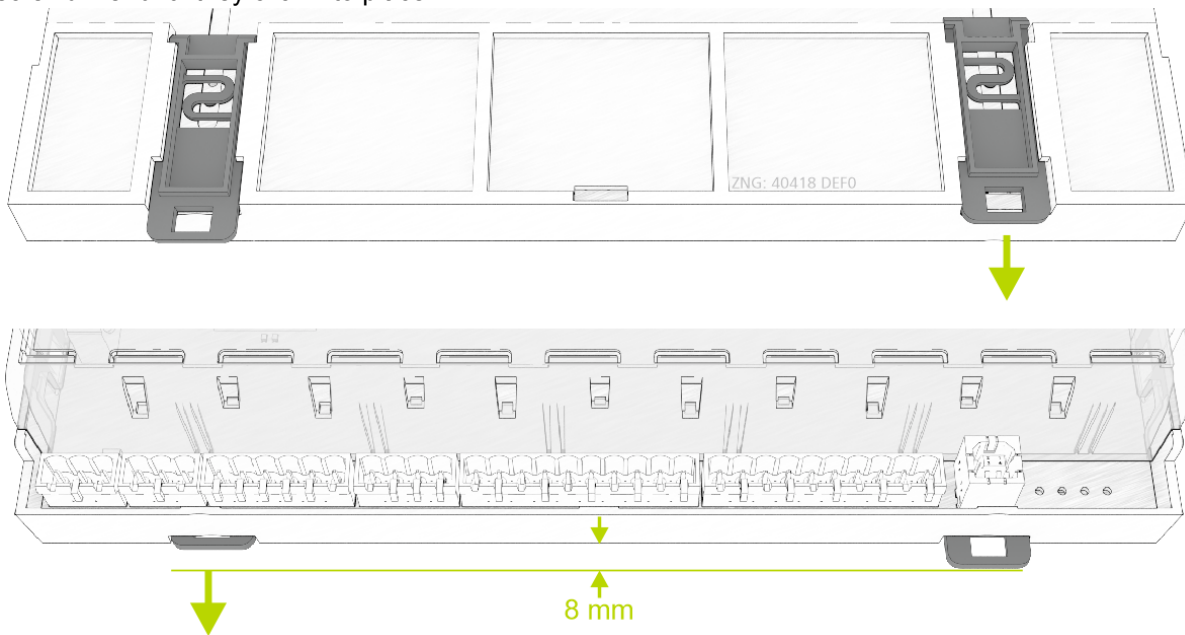

i In order to carry out the assembly / dismantling, there must be a distance of at least 8 mm from the next component (e.g. cable duct), otherwise the retaining springs cannot be pulled out.

Eckelmann

Step 2: Place the case controller on the top edge of the DIN rail (A) and swivel downwards until the case controller is positioned on the lower edge of the DIN rail.

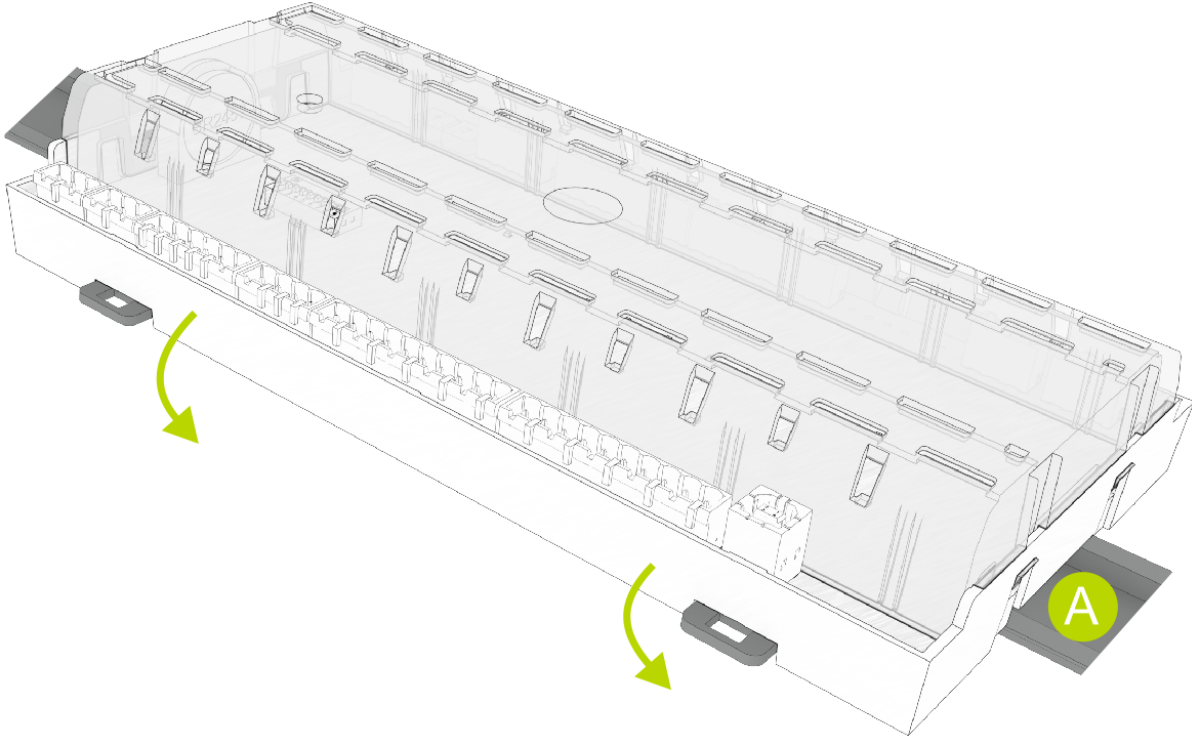

Step 3: Press in the two retaining springs until they click into place and check that the case controller is firmly attached to the DIN rail.

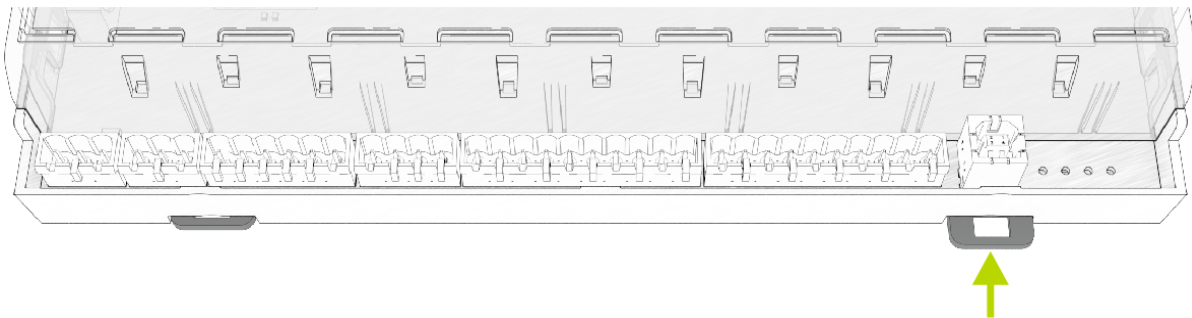

i The controller can be put into operation after completion of the mechanical and electrical installation of the case controller.

6.1.1.2 Disassembling from the DIN rail

⚠ Warning - hazardous electrical voltage! Danger of electric shock! When disassembling the safety instructions and work safety instructions **must** be observed. **All** connectors may only be connected and disconnected when power is off.

Step 1: Pull all mating plugs with cable from the case controller.

Step 2: Pull out the two retaining springs with a flat-bladed screwdriver until they click into place.

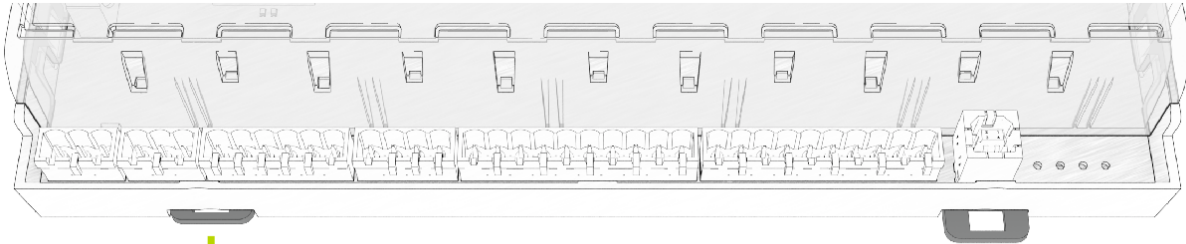

Step 3: Remove the device from the DIN rail (A) by tilting it upwards.

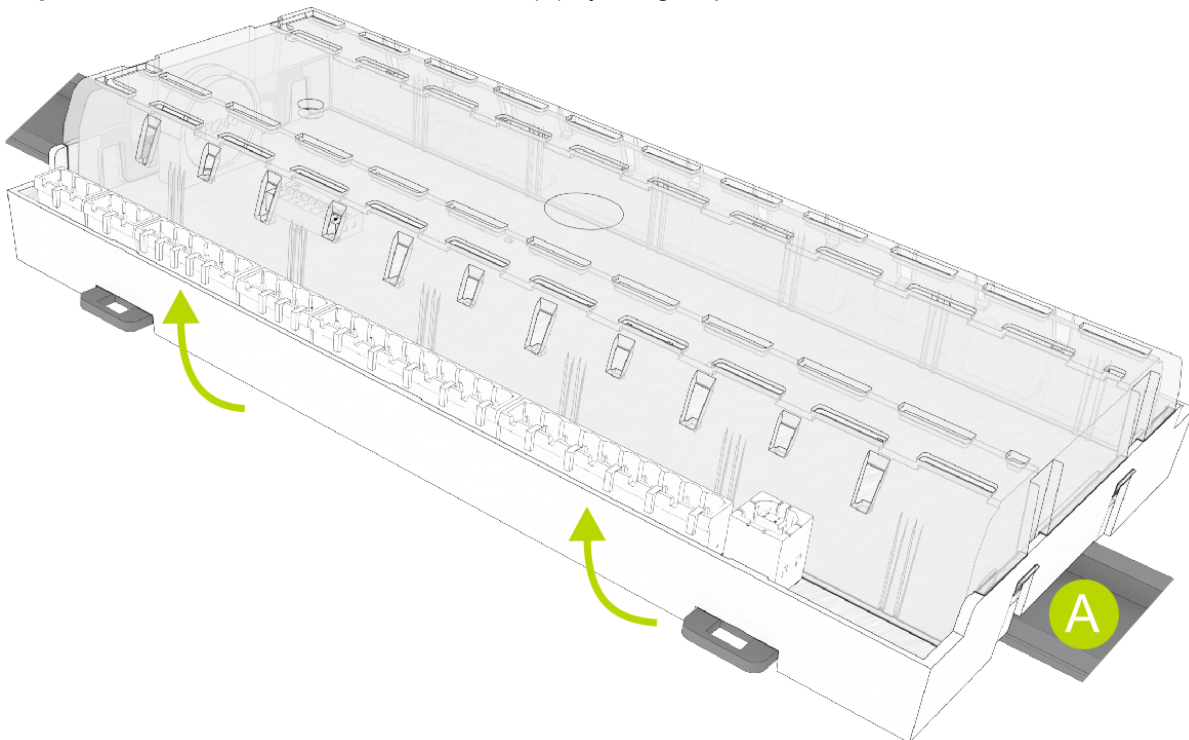

6.1.2 Handling of the spring terminals

All terminal connections of the controller are implemented with mating connectors with spring terminals (push-in spring connection) and have the following characteristics:

- Conductors with cross sections between 0.25 and 2.5 mm² can be used.
- All mating connectors are coded and any reverse polarity is therefore ruled out.

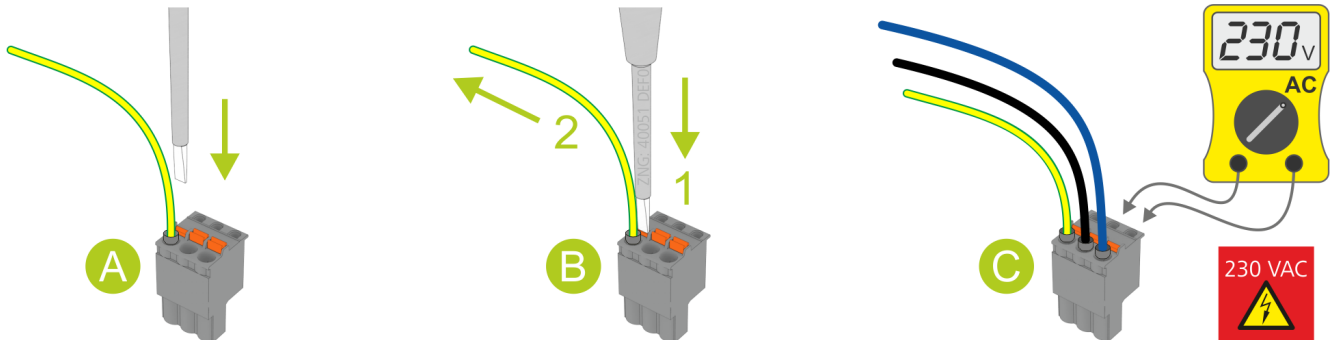

A - Installation

For fast installation without tools, direct conductor connection of prefabricated cables (these with 10 mm wire end sleeves) by simply inserting into the spring terminal is also possible. The orange push button must also be pressed during insertion to connect flexible wires of 0.25 to 2.5 mm² without wire end sleeve.

B - Disconnection

The wires are disconnected using a screwdriver (max. 3.5 mm width) via the orange push button at the terminal connection that has no direct contact to live parts.

Step 1: Press the orange push button vertically downwards using a screwdriver to detach the connection.

Step 2: Pull wire upwards.

C - Test

For voltage testing, each terminal connection has openings for probe tips of multimeters that are designed with protection against direct contact.

NOTICE

Risk of damage! All mating connectors **must always** be guided vertically and attached / disconnected without twisting so that the pins on the main board are not bent and damaged.

6.2 Basic settings

Settings BEFORE the connection of the power supply - S1, S2, S3

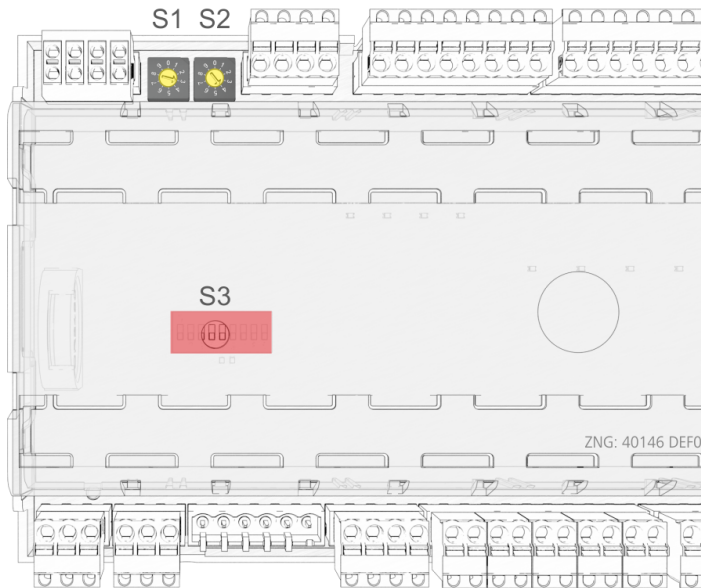

- **Decade switches S1 and S2:**
 - Setting of the CAN bus address (node number) 1..99, see chapter [Setting the CAN bus address](#)
- **DIP switch S3:**
 - Controller type setting
 - Master / Slave mode
 - Setting of special functions, see chapter [Setting of the controller type and master/slave mode](#)

Settings AFTER application of the power supply

- [Erstanlauf - Regler auf Werkseinstellungen zurücksetzen](#) (optional setting to default values to reach a defined initial state for a running operation)
- Configuration of the controller, see chapter [Grundkonfiguration des Reglers](#)

6.2.1 Setting the CAN bus address

Setting of the CAN bus address ($Kn.nnn = 1..99$) is performed using the two decade switches **S1** and **S2**. An individual CAN bus address must first be set at the two decade switches on all case controllers that are installed in refrigerated cases **before** commissioning.

⚠ Risk of confusion! In order to avoid mix-ups, it is recommended to use the position number of the refrigerated case as CAN bus address. A different CAN bus address that must be unique in this system must be allocated to each refrigeration point. The CAN bus address is inactive if both decade switches are set to 0 (i.e. the address is 00). The controller is **not** recognised as a bus node.

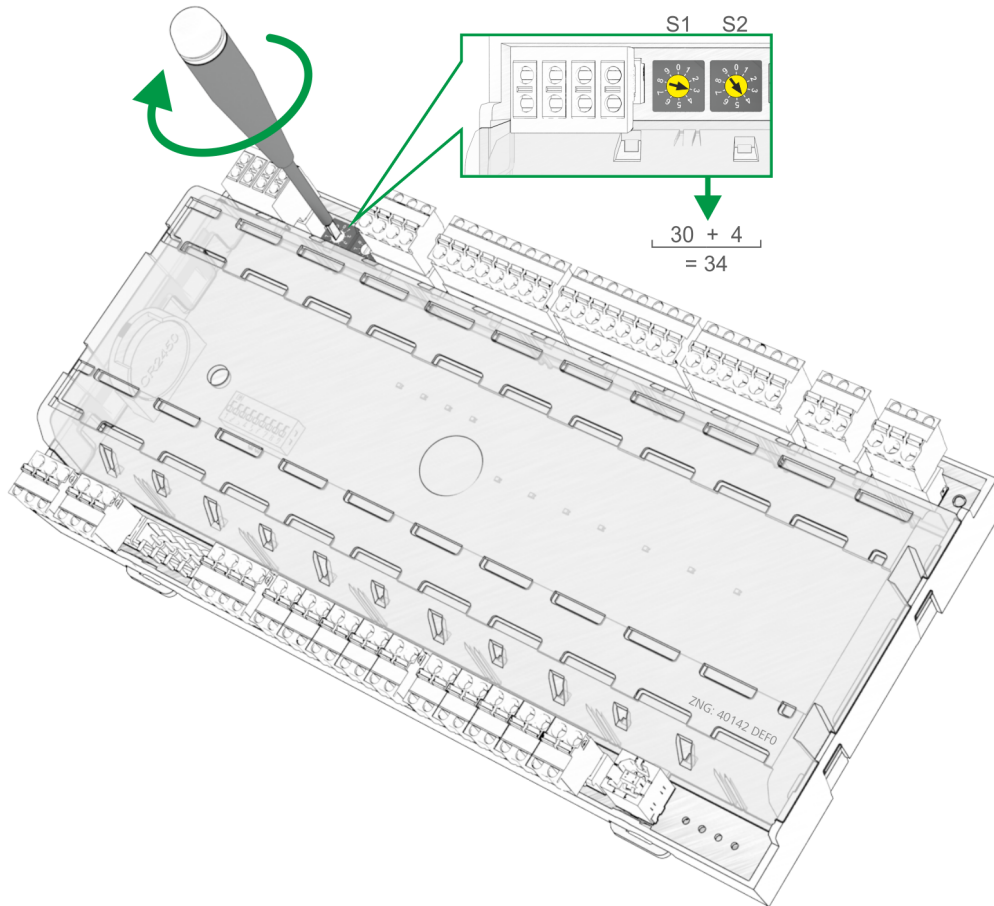

S1 (10 position)	S2 (1 position)	Configured CAN bus address	Function
0	0	00	CAN bus interface inactive (disabled)
0	1..9	01..09	Case controller: CAN bus address assigned
1..9	0..9	10..99	

Example:

S1 = 3 = 3 x 10 = 30 and

S2 = 4 = 4 x 1 = 4

→ CAN bus address = S1 + S2 = 30 + 4 = **34**

i The case controller does not accept the settings on the decade switches **S1** and **S2** until after the controller has been briefly disconnected from the power supply! In the case of case controllers that are installed in a switch cabinet, the CAN bus address has been set by the manufacturer. However, it can be subsequently adjusted.

6.2.2 Setting of the controller type and master/slave mode

⚠ Caution: data loss! All parameters are reset to their factory settings if the controller type is changed or due to a first start (see chapter [First start / reset controller to factory settings!](#))

Setting of the controller type

The required controller type can be set via the **DIP switch S3** by adjusting the coding switches 1..9 with a thin screwdriver (D = 2 mm) through a hole in the case cover:

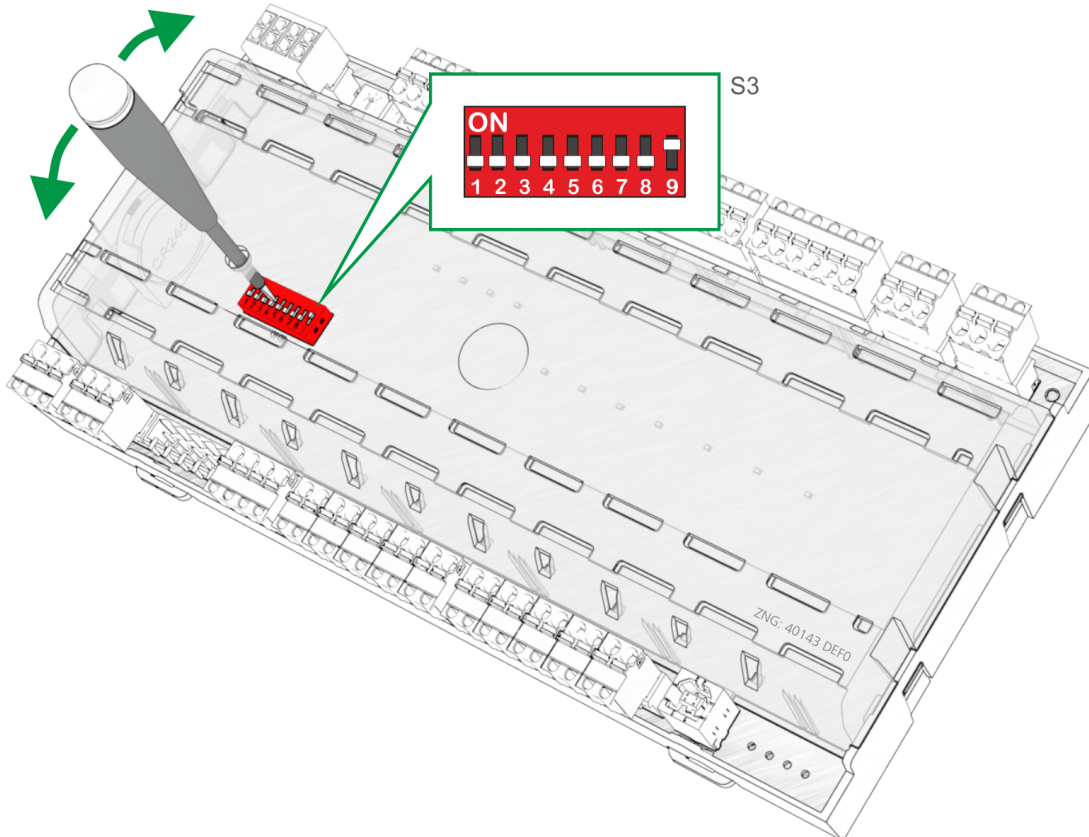

Depending on the now set controller type, the respective functionalities are then displayed or hidden in the menu of the controller. 8 controller types are available for the definition of the basic controller behaviour, see chapter [Controller types](#).

⚠ Warning about dangerous electrical voltage!
Danger of electric shock! The DIP switch S3 may only be adjusted when **disconnected from the power supply**. The changes are not applied until the next time the controller is switched on.

DIP switch S3

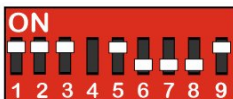

Example: Setting of the coding switches for the controller type UA 131 LS.

The following controller types can be set using the DIP switch S3:

Controller type or master / slave mode		DIP switch S3 (switch positions of the coding switches 1 .. 9)								
		1	2	3	4 Master / Slave mode	5	6	7	8	9 Nor mal Ope rati on / Fir mw are Upd ate (onl y 2nd gen erat ion con troll ers)
Case controller	UA 111	OFF	OFF	OFF	ON/OFF	OFF	OFF	OFF	OFF	ON
	UA 111 D	OFF	ON	ON	ON/OFF	OFF	OFF	OFF	OFF	ON
	UA 121	ON	OFF	OFF	ON/OFF	OFF	OFF	OFF	OFF	ON
	UA 131 without fan control UA 131 with fan control (terminals 73/74)	OFF	ON	OFF	ON/OFF	OFF ON	OFF	OFF	OFF	ON
	UA 131 LS with enhanced fan control (terminals 15/16/18)	ON	ON	ON	ON/OFF	ON	OFF	OFF	OFF	ON
	UA 131 DD	ON	ON	ON	OFF	OFF	OFF	OFF	OFF	ON
	UA 141	ON	ON	OFF	ON/OFF	OFF	OFF	OFF	OFF	ON
Cold room controller	UR 141 NK	OFF	OFF	ON	ON/OFF	OFF	OFF	OFF	OFF	ON
	UR 141 TK	ON	OFF	ON	ON/OFF	OFF	OFF	OFF	OFF	ON

* Enable of special functions. Information about whether the DIP switch 8 must be set to ON can be found for the corresponding functions in the chapter [Function of UA 400 / UA 410](#). After the DIP switch 8 has been changed, a controller restart must always be performed, otherwise the setting will not be adopted.

Due to the setting of the controller type, only a part of the functions and parameters of the case controller is always available.

In the case of any setting of coding switch combinations that are not present in the list, UA 131 is automatically applied as controller type and an alarm message is created.

- ⓘ Operation with an unsupported DIP switch setting is not permitted. In the case of any setting of coding switch combinations that are not present in the list, UA 131 is automatically applied as controller type and an alarm message is created. In the event of change of the controller type, all parameters are reset to their factory settings.

Master / Slave mode

The Master / Slave mode is set using the coding switch **4** of the DIP switch **S3**:

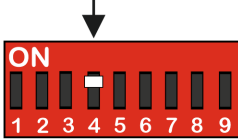

ON = Master / Slave mode ON

OFF = Master / Slave mode OFF

- ⓘ The case controller does not accept the changes on the DIP switch **S3** until after the controller has been briefly disconnected from the power supply!

6.3 Terminal assignment for 230 V AC power supply

- ⚠ **Warning - hazardous electrical voltage!**
Danger of electric shock! BEFORE and AFTER connection it must be checked that the 230 V AC supply cable is **off load!**

The power supply cable is connected to the case controller using the right hand terminal block PE/L/N:

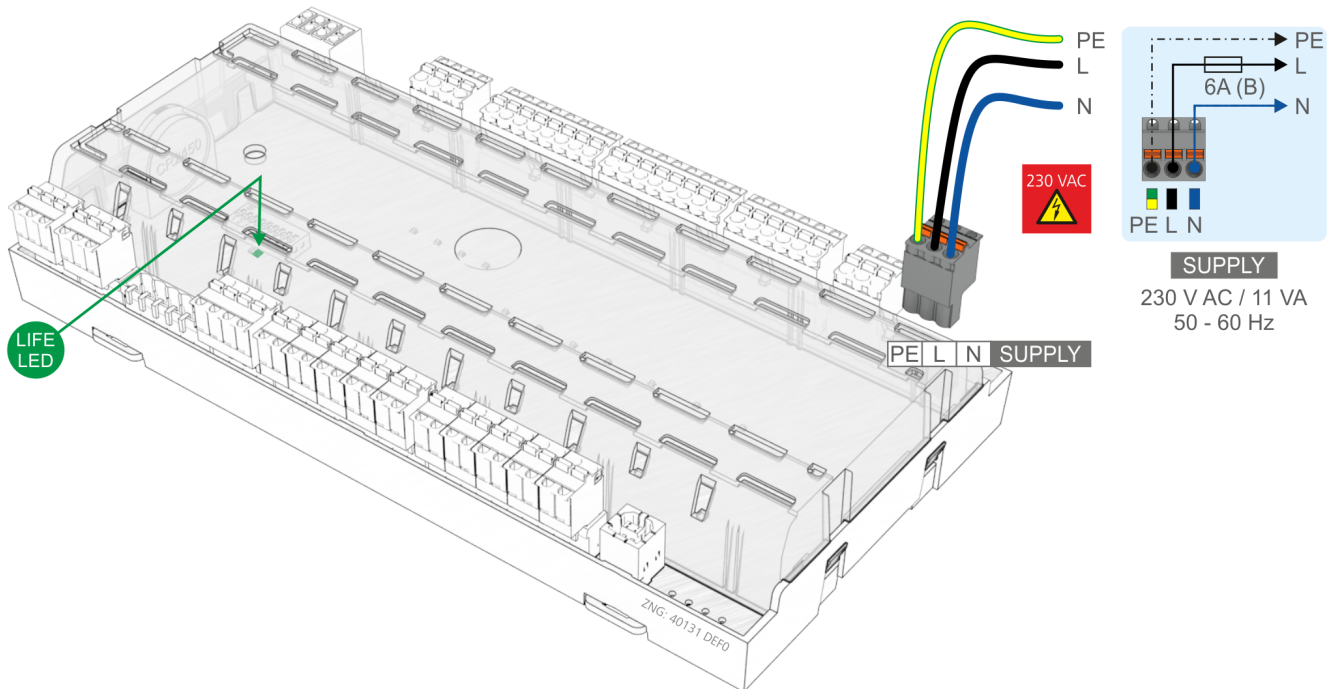

The case controller can now be supplied with power. If power is being received the active lamp (LIFE LED) flashes for approximately 10 seconds following actuation. If the case controller is also connected to the CAN bus, then the CAN bus LED flashes. For more details on the status LEDs see chapter [Status LEDs](#).

6.3.1 Status LEDs

⚠ DANGER

Warning about dangerous electrical voltage! Danger of electric shock! The device must never be operated without its case. Before opening the case, the device must be disconnected from the power supply.

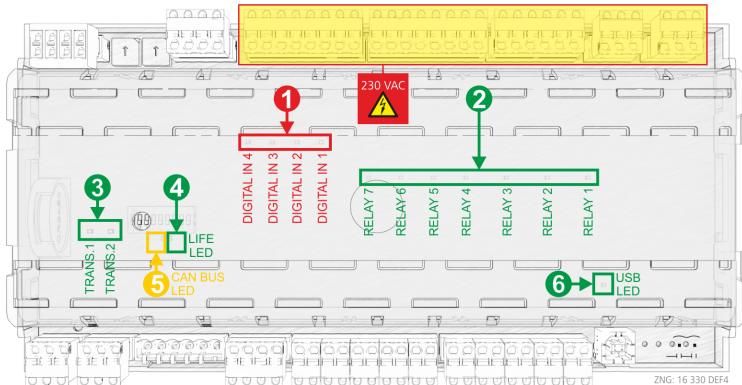

	Function	Colour	LED	Description
1	230 V AC Digital inputs	red	LED2 LED3 LED4 LED5	<p>ON: Digital input 1 is activated (terminals D11/D12) ON: Digital input 2 is activated (terminals D21/D22) ON: Digital input 3 is activated (terminals D31/D32) ON: Digital input 4 is activated (terminals D41/D42)</p> <p>ATTENTION: External voltage can be present at these terminals!</p>
2	230 V AC Relay outputs	green	LED6 LED7 LED8 LED9 LED10 LED11 LED12	<p>ON: Relay 1 is switched (terminals 15/16/18) ON: Relay 2 is switched (terminals 25/26/28) ON: Relay 2 is switched (terminals 35/36/38) ON: Relay 4 is switched (terminals 43/44) ON: Relay 5 is switched (terminals 53/54) ON: Relay 6 is switched (terminals 63/64) ON: Relay 7 is switched (terminals 73/74)</p> <p>ATTENTION: External voltage can be present at these terminals!</p>
3	Transistor outputs	green	LED13 LED14	<p>ON: Transistor output 1 is switched (terminals 81..83) ON: Transistor output 2 is switched (terminals 91..93)</p>
4	LIFE	green	LED15	<p>Controller with 8-pole DIP switch</p> <ul style="list-style-type: none"> FLASHING: Active lamp, controller is supplied with power, processor is running or controller is in firmware update mode (all coding switches 1..8 of DIP S3 are ON), for details see chapter OFF: Power supply interrupted or device defective Update für Regler mit 8-poligem DIP-Schalter <p>Controller with 9-pole DIP switch</p> <ul style="list-style-type: none"> FLASHING: Active lamp, controller is supplied with power, processor is running OFF: Power supply interrupted or device defective or controller is in firmware update mode (coding switch 9 of DIP S3 is ON), for details see chapter Update für Regler mit 9-poligem DIP-Schalter
5	CAN bus	orange	LED1	<ul style="list-style-type: none"> FLASHING: LED always flashes when data are being exchanged via the CAN bus with the system centre / store computer. OFF: CAN bus connection interrupted or CAN bus defective

Eckelmann

	Function	Colour	LED	Description
6	USB	green	LED16	<ul style="list-style-type: none">• ON: Connected to PC or data exchange via USB port• OFF: USB connection interrupted or USB connection defective

6.4 Basic configuration of the controller

The lock-down must previously be deactivated on the higher level controller (system centre / store computer or operator terminal) so that configuration settings can be made on the controller.

1. Cancelling entry block

- A. BT 300 operator interface; for details, see chapter [Lock-down of the setpoint change](#)
- B. System centre via Login symbol; for details, see chapter [System Centre](#).
- C. Store computer / operator terminal menu 8-3; for details, see chapter [Store computer CI 3x00 / operator terminal AL 300](#)

2. Opening main menu of the controller

- A. The main menu of the controller is shown directly in the operator interface.
- B. In the system centre, select the required controller in **Menu 4-2** and then tap the **Remote Control button** to display the main menu of the controller.
- C. In the store computer and operator terminal, a selection list of all CAN bus components is displayed in **Menu 5 Remote Control**. Select the controller with the corresponding CAN bus address (Kn,nnn = 1..99) to be parametrised in the selection list using the cursor or direct input and recall by tapping the **ENTER** button so that the main menu of the controller is displayed.

3. Basic configuration of the controller - select refrigeration point (Menu 6-1)

 The menus shown below only provide the overview; the display can be different for certain controller types. Details are described in the chapter [Menüstruktur UA 400](#).

In order to define the refrigeration point to be regulated by the case controller, various parameters can be entered and checked:

6 Configuration - 1 Refrigeration point	
KÜHLSTELLEPOS: XXX	
Refr. Pt. Name: XXXXXX	Check refrigeration point name (can only be freely edited using system centre)
Position: XXXXX	Check refrigeration point Item ID (can only be freely edited using system centre)
Priority: X	Alarm priority 0..99 (observe notes in chapter 10.1 "Alarm signalling")
Verbund Nr.: X	Number of the compressor pack that supplies the refrigeration point (1 to 9, important for multiple compressor packs)
Verbundsatz: XXX	Zone of the compressor pack that supplies the refrigeration point (Z1/Z2 only for VS 3010 BS)
Temperaturzonen X	Division of the refrigeration point into 1 or 2 zones
Fühleranzahl XX	Number of sensors. The number of connected sensors is scanned after leaving the parameter with the ENTER button.

⚠ Risk of failure of alarm messaging in the event of problems! Alarms can be suppressed if the alarm priority is set to 0. The value of the suction pressure for the control functions is not available to the case controller **until after** the pack number of the associated pack controller has been selected on the case controller.

Risk of damage to the system and stock loss! It must be strictly ensured that the correct pack number is set, otherwise this can result in damage to the installation or stock. The setting can be checked at Refrigeration point - 1 Actual values - 1 Temperature sensors. The value t_0 VS *korr.* displayed there is the offset corrected t actual value of the pack controller as indicated in the pack number field. In standalone operation via the local pressure transmitter, the pack number and the parameter t_0 VS *korr.* only have any meaning if the signal from the pressure transmitter is not available. In this case, the controller attempts to replace the missing signal with a pressure value measured at the pack controller and transmitted via the CAN bus (if available).

i A sensor scan (Menu 6-1) **must** be performed during commissioning or after a first start! The sensor scan is the only possibility to define the sensors to be monitored; see chapter [Notwendige und optionale Fühler](#).

4. Exit from the menu 1 Refrigeration point by tapping the ESC button once and select menu 6 Configuration - 2 Controller.

6 Configuration - 2 Controller	
REGLERPOS: XXX	
1 Type and version	Type, serial number and Master / Slave (ON/OFF)
2 Temperature display	Adjustment of the displayed temperature value
3 Alarm delay	Input of an alarm delay time
4 230 V inputs	230 V inputs
5 Sensor type	Selection of the temperature sensor of the type L243, K277 or 5K3A1

5. Select menu 6 Configuration - 2 Controller - 3 Alarm delay.

6 Configuration – 2 Controller – 3 Alarm delay.	
ALARMVERZ.POS: XXX	
Fühlerbruch XXm	Alarm delay for sensor fault
Über/Unter Tmp XXXm	Alarm delay for high temperature or low temperature
keine Abtauung XXXh	Alarm is tripped if no defrost is performed within this configurable time.
SelbsthaltungN	NO: Automatic reset of non-transient alarms YES: Alarms must be reset manually

Exit the menu by tapping the **ESC** button once.

6. Select menu **6 Configuration – 3 Cooling**.

6 Configuration - 3 Cooling	
KÜHLUNGPOS: XXX	
Korroff. to XXX	Correction offset which is applied to the t 0 actual value received from the pack controller via CAN bus. This enables pressure losses in the refrigerant line to be compensated. If this value is set to "-", the case controller regulates using the temperature sensors at the evaporator input and output (standalone operation).
Dauerl.Überw. XXm	Continuous use monitoring
DG-Betrieb AUS	This must be set for UA 131 E to guarantee that the D2D defrost runs correctly. The defrost timer should be set to EXT when activating this operating mode.
Lüfterverzöger XX°C	Maximum value at the defrost sensor, at which the fan should be switched on after a delay (e.g. after the defrost)

7. Exit the **Configuration** menu by tapping the **ESC** button twice and select **3 Clock – 2 Defrost timer** Input of the relevant parameters in the following screen.

3 Clock - 2 Defrost Timer	
ABTAUUHRPOS: XXX	
AbtauuhrINT	Selection of defrost using external or internal defrost timer
Sicherheitsz.60m	Safe defrost time; the defrost is not longer than this time.
Defrost 1 DD-DD hh:mm	Entry of defrost times
Defrost 2 DD-DD hh:mm	
...	
Defrost 14 DD-DD hh:mm	
man. AbtauungAUS	Manual defrost ON/OFF

8. Exit from the **2 Defrost Timer** menu by tapping the **ESC** button.

9. Select menu **3 Toggle Setpoint**, input of the relevant parameters in the following screen:

3 Clock - 3 Toggle Setpoint	
UMSCHALTNGPOS: XXX	
StatusAUS	Only visible if Sollumschaltg. is set to INT or EXT
Sollumschaltg.EXT	Selection INT, EXT, --: internal, external, deactivated toggle setpoint Selection INT: internal EXT: external --: deactivated toggle setpoint
Laufzeit Rollo0s	Input operating time of the blind of the multidecks
Um EIN: DD-DD hh:mm	Input time for toggle setpoint (only visible if Sollumschaltg. is set to INT)

Eckelmann

3 Clock - 3 Toggle Setpoint	
Um AUS: DD-DD hh:mm	
Um EIN: DD-DD hh:mm	
Um AUS: DD-DD hh:mm	

10. Tap the **ESC** button twice to exit the menu **3 Toggle Setpoint**.

11. Select menu **2 Setpoints - 1 Cooling - Zone 1 / Zone 2 / Zone 1U / Zone 2U**.

2 Setpoints - 1 Cooling - Zone 1 - 2 - Um1 - Um2	
KÜHLUNG xPOS: XXX	
...	
Überhitzung XK	Superheat setpoint of the superheat controller
Min. Überh. XK	If the minimum superheat is undercut, the controller closes the associated E-valve and sets the I-sum (NOT: I-component) to 0 if the parameter <i>Reset I-Summ</i> is set to ON.
Zweipunktreg .AUS	The temperature control no longer operates continuously but as on-off controller. This is used for enable / disable of the superheat control (TEV emulation).
MOP-Punkt XX°C	A value not equal to "-" must be set here if the MOP function is required. If t0 exceeds this value, the opening degree is reduced as t0 rises.

12. Return to the main menu of the store computer / operator terminal by tapping the **ESC** button multiple times.

13. Select the menu **7 Monitoring - 3 Configuration** in the main menu of the store computer / operator terminal and input, among other things, the node name of the case controller in plain text.

7 Monitoring - 3 Configuration	
KONFIGURATION Kn.nnn	Input of the CAN bus address: Select the case controller with the corresponding CAN bus address (node No. = 1..99) to be parametrised using the cursor or by direct input.
Teilnehmername	Input node name (e.g. Cheese Counter)
Position XXXXX	Input of the position of the node in the store
Priorität X	Input of the desired priority

14. **Ending basic configuration of the controller** Tap the **ESC** button multiple times to return to the main menu. This ends the basic configuration.

6.4.1 Naming of the controller

The following parameters are available for naming the controller:

- Refrigeration point name (19 characters, can be freely edited)
- Refrigeration point position (5 characters, can be freely edited)

The controller can be named using the system centre, store computer, operator terminal or the PC software LDSWin.

A. BT 300 operator interface the input is made in Menu 6-1.

 Any naming of the controller with a BT 300 x operator interface is only possible for the UA 410 L controller.

B. System centre See chapter [System Centre](#) for details.

A. Store computer / operator terminal the input is made in Menu 7-2.

D. PC software LDSWin See operating manual of LDSWin.

6.5 Battery replacement

Only UA 400 AC

The case controller has a buffer battery of the **type CR 2450 N, 3 V Lithium**. In order to change the battery, it is necessary to remove the case controller from the system. In this case, the refrigeration point is **not** regulated and monitored!

DANGER

- **Warning about dangerous electrical voltage! Danger of electric shock!** The safety regulations and work safety instructions in chapter [Conventions](#) must be observed for the battery replacement. A battery replacement may **only** be performed by trained personnel or at the factory by the manufacturer!
- **All** plug connectors may only be inserted and removed when the **power supply is disconnected**. Label connector if necessary before the removal and then detach.
- Circuit boards may only be replaced when the **power supply is disconnected**. Always hold circuit boards at the edge.



Observe ESD (Electrostatic Discharge) regulations (see manual [ESD - Rules for handling and working](#))!

- **Risk of false alarm!** The removal of the controller from the CAN bus generates an error message in the higher level controller ([System Centre](#)). Therefore, in addition to the precautionary measures that directly affect the control, consequences on the higher level controllers connected to the CAN bus must also be considered. It must be ensured that [Activating service mode](#) is activated on the higher level controller and that the service centre has previously been informed accordingly.

Performing the battery replacement

1. Disconnect case controller and refrigeration point from the power supply. Acknowledge alarm in the higher level controller if necessary.
2. Disconnect all plug connectors, remove the device from the DIN rail.

- **Warning about dangerous electrical voltage! Danger of electric shock!** A voltage of 230 V AC can be present on some connectors.

3. **(A)** Push the plastic lid's two left-hand snap lugs on the side upwards with a broad flat blade screwdriver and
(B) lift up the lid with a swivelling movement.

(C) Pull the battery (C) upwards out of the battery holder and dispose of it correctly.

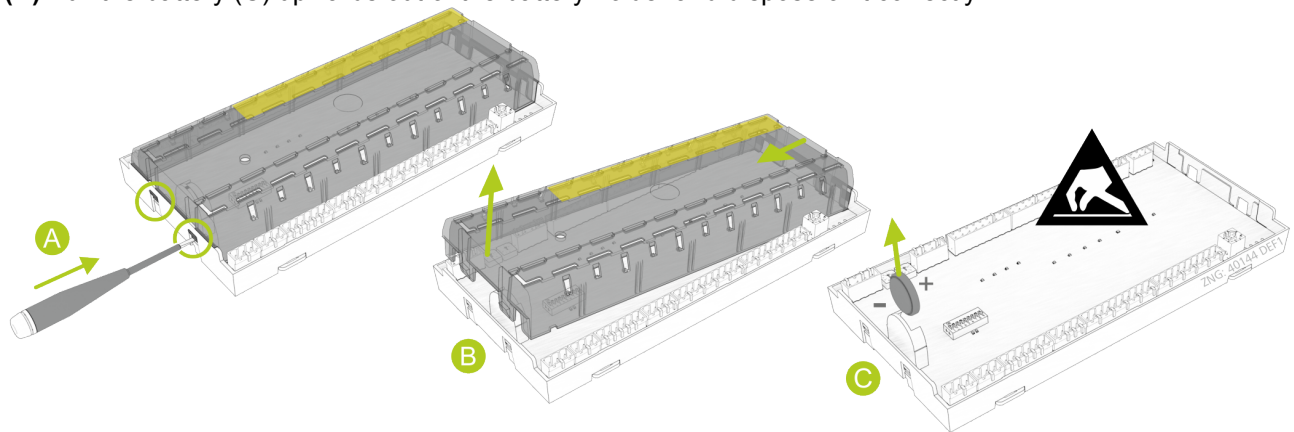

The device contains a lithium battery (for details, see chapter [Disposal](#)) that must be correctly disposed of separately!

Never dispose of this product with other domestic waste. Please inform yourself about the local regulations for the separated disposal of electrical and electronic products and batteries. The correct disposal of your old equipment protects the environment and people against possible negative consequences.

4. Pick up the new battery with a cloth and press it into the battery holder.

i Do **not** handle the new battery with metal pliers as the battery can be destroyed by the resulting short circuit:

- wipe with a clean and dry cloth.
- do **not** hold on the edge contact areas.

5. Check that the lid is in the correct position and push it down until it clicks into place.

6. Put device on the DIN rail and attach all connectors again.

⚡ Warning about dangerous electrical voltage! Danger of electric shock! A voltage of 230 V AC can be present on some connectors.

7. Restore power to the case controller and refrigeration point. Refrigeration point operates again.

8. **Controller in the CAN bus system:** With unchanged configuration of the system centre / store computer, the controller is automatically detected again via the CAN bus; date, time and automatic summer / winter time changeover are set automatically via the central time synchronisation.

9. **Controller in standalone operation:** The setting of date, time and automatic summer / winter time changeover is required for the data archiving (Menu 3-1).

In the case of [Restart - restart of the controller](#), (error) messages are output. These must be checked / acknowledged in the higher level controller or using the set-up unit!

6.6 Firmware Update

The case controller is supplied with the current firmware, ready for operation. Future software versions can be loaded into the case controller as required by means of a firmware update, and thus updated.

 A software update must only be performed by trained personnel is only to be carried out by trained personnel or at the factory by the manufacturer. Further details about the current firmware can be found in [E°EDP](#).

 **Damage to the system and stock loss! Before** the firmware update, the affected system component and the system must be brought into a safe state as the shutdown of the controller during the firmware update can have undesired effects on the system component and/or the system.



Caution: data loss! The loading of software via firmware update must not be interrupted. The power cable and USB A-B cable must not be disconnected during the firmware update. It must be ensured that power is supplied throughout the entire process. Any interruption of the firmware update can result in an inoperative controller. In some cases, a change of firmware version can result in the loss of all the adjusted setpoints in the case controller. As a precaution, the settings **should** therefore be backed up by saving them using the LDSWin PC software **before** the firmware update. After the firmware update, the saved settings can be reloaded into the case controller from LDSWin.

6.6.1 Requirements for firmware update

The following components are required for a firmware update:

- The controller for which the update is intended.

Special feature: Two device generations are available. The DIP switch S3 provides a quick distinguishing feature:

<p>2nd generation controller (from Oct. Nov. 2018) with 9-pole DIP switch</p> 	<p>1st generation controller (since 2011) with 8-pole DIP switch</p> 
---	---

Note: The settings depend on the controller type!

- Laptop or PC with Windows 7 / Windows 8 / Windows 10
- USB A-B cable *
- The following files are required for the firmware update *
 - The installation program "*Firmware_Uploader_Setup_vxx.exe*" (download as ZIP file)
 - The firmware files "*UA400_vx.xx.bin*", "*UA400_vx.xx.dfu*" or "*UA400_vx.xx.hex*" (download as ZIP file)

Note: After the download, all ZIP files must be extracted to any directory.

i **Administrator rights and an existing internet connection required during the initial installation!** With the operating systems Windows 2000, XP, Vista, Windows 7 and Windows 10, the PC **must** have an **existing internet connection** and the user **must** have **administrator rights** during installation while the installation program "*Firmware_Uploader_Setup_vxx.exe*" is being executed. Administrator rights will also be required when the controller is initially connected to the PC and the driver is installed by the operating system. Following installation and the initial connection of the controller to the PC, administrator rights are no longer required. In the event of questions concerning "administrator rights under Windows", the responsible IT administrator should be consulted.

Step 1: Install software

Before the first connection of the controller to the PC, the installation program "*Firmware_Uploader_Setup_vxx.exe*" must first be executed **once**. Please follow the instructions given by the installation wizard. The components to be installed can be selected in the following window.

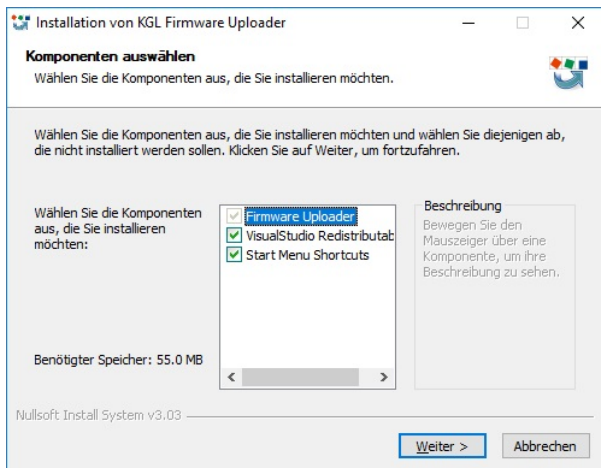

Then select the target directory:

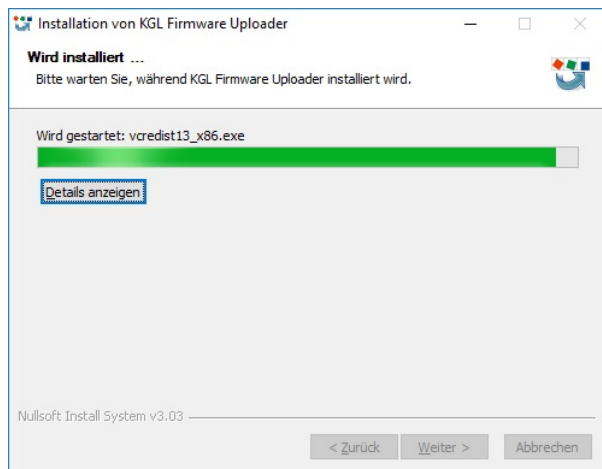
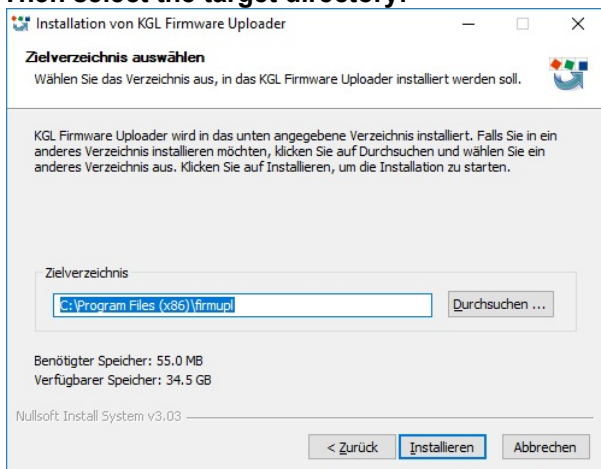

The installation of "Microsoft Visual C++ 2013 Redistributable" is started automatically after the installation of the firmware uploader:

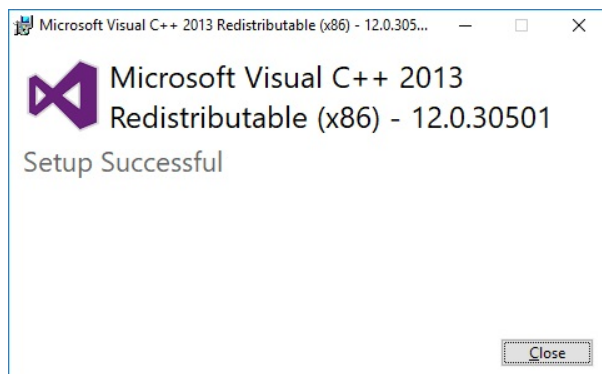
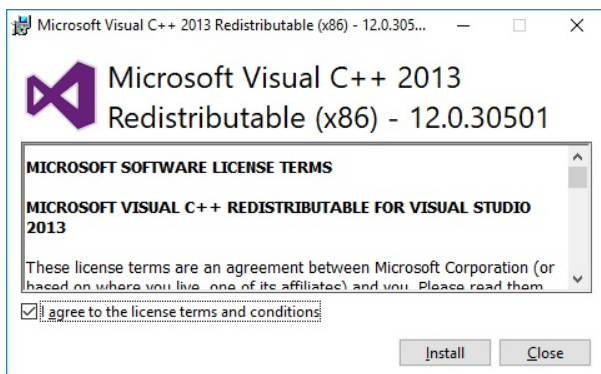

Note: Set a checkmark in the first screen to accept the licence agreement.

Step 2: The PC must be restarted after the installation process:

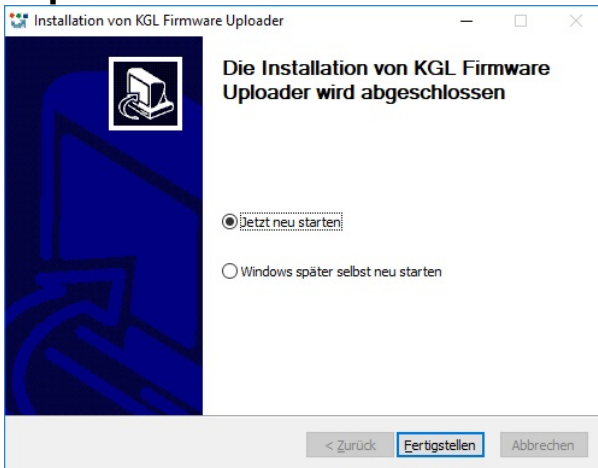

i No error message such as "USB device not found" should be displayed on the laptop or PC. *

* Further information:

- USB cable: see chapter [Zubehör](#)
- Installation program & firmware: see https://edp.eckelmann.de/edp/lds/_NbH4owBiFn
- Tips for [Rectification of driver problems](#)

6.6.2 Installing firmware update

When installing the firmware update, a distinction is made between two device generations:

- **2nd generation controller (from Oct./Nov. 2018)**
Characteristic: 9-pole DIP switch



- **1st generation controller (since 2011)**
Characteristic: 8-pole DIP switch

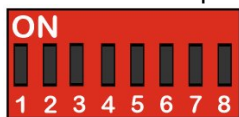

6.6.2.1 Update for controller with 9-pole DIP switch

Controller characteristic: 9-pole DIP switch



The settings depend on the controller type!

i The steps described in the chapter [Voraussetzungen für das Firmware-Update](#) must have been performed once for each PC in order to perform a successful firmware update.

Step 1: Set DIP switch S3 and connect controller to PC

Practical tip: The original position of the coding switches 1..9 of the DIP switch S3 should be documented, e.g. with a mobile telephone photo.

Before starting the firmware update, only coding switch 9 of the DIP switch S3 **must** be set to **OFF**:

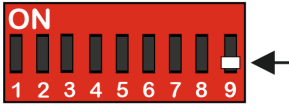

After the firmware update has been performed, the coding switch 9 of DIP switch S3 must be **reset to its original position**.

Connect the controller to the PC via a USB A-B cable while **disconnected from the power supply**:

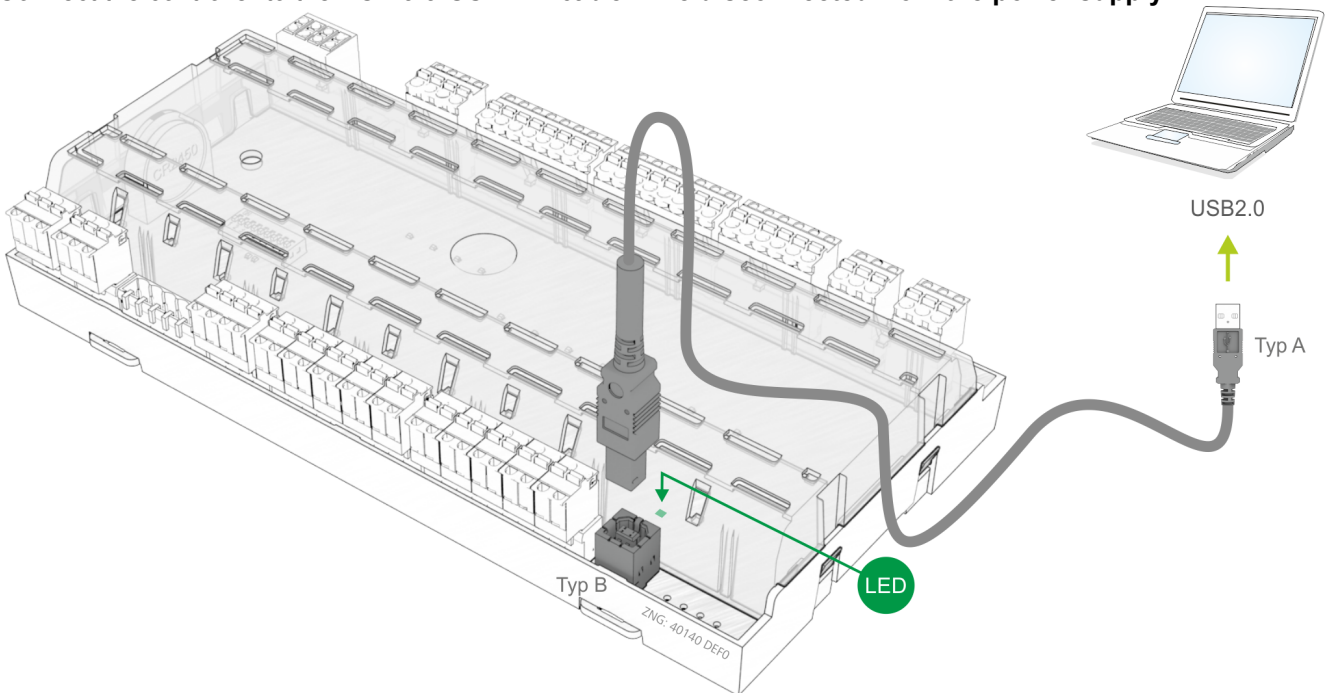

then supply the controller with power again, see chapter [Terminal assignment for 230 V AC power supply](#).

Step 2: Perform firmware installation

Under "*Start / Programs / ECKELMANN / Firmware Uploader*", start the program "*KGL Firmware Uploader*". The following window opens:

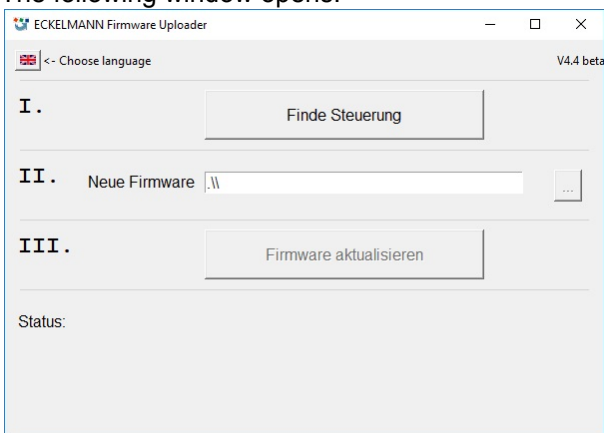

Click the "Find Controller" button to find the controller.

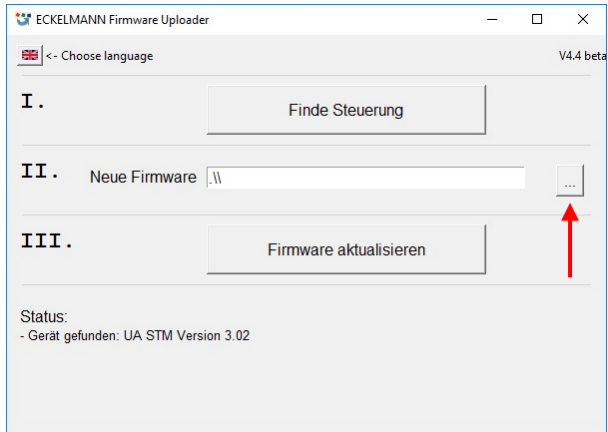

A notification is displayed in the status field if the controller has been found. Then select the current firmware file ("xxx.hex") from the directory into which the ZIP file was extracted (see arrow).

After the conversion, tap the button "Update firmware" to start the firmware upload:

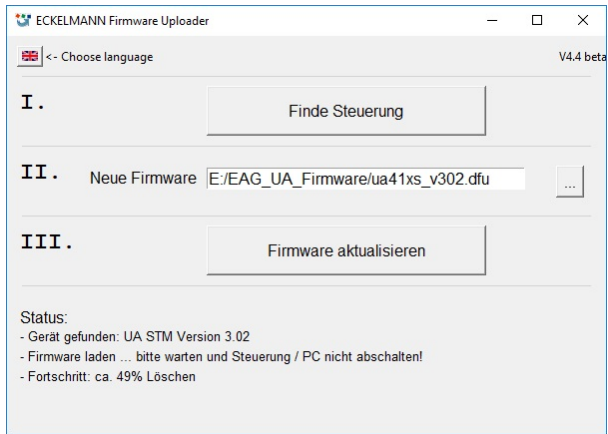

The program can be ended after the successful firmware update by closing the window.

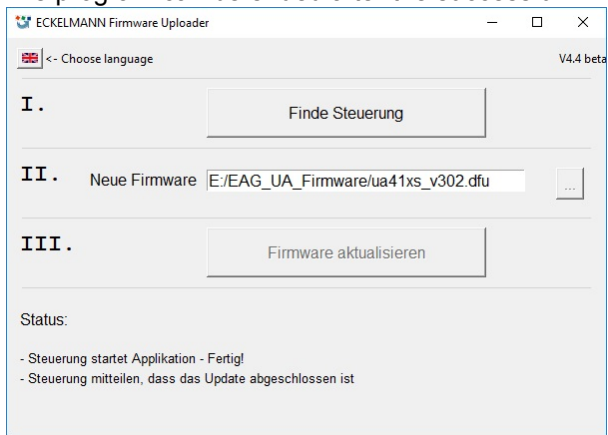



The USB A-B cable can now be disconnected from the controller.

Step 3: Reset DIP switch S3

After performing a firmware update, **only** the coding switch 9 of the DIP switch S3 **must be reset to ON**:



 **Risk of controller failure!** The controller only accepts the settings for DIP switch S3 **after** the controller has been briefly disconnected from the power supply!

 After the firmware update, the saved settings can be reloaded into the case controller from LDSWin as required..

6.6.2.2 Update for controller with 8-pole DIP switch

Controller characteristic: 8-pole DIP switch



The settings depend on the controller type!

- i** The steps described in the chapter [Voraussetzungen für das Firmware-Update](#) must have been performed once for each PC in order to perform a successful firmware update.

Step 1: Set DIP switch S3 and connect controller to PC

- i** **Practical tip:** The original position of the coding switches 1..8 of the DIP switch S3 should be documented, e.g. with a mobile telephone photo.

Before starting the firmware update, all coding switches 1..8 of the DIP switch S3 **must** be set to **ON**:

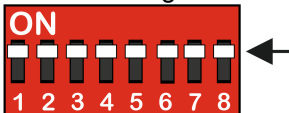

- i** **After** the firmware update has been performed, the coding switch 9 of DIP switch S3 must be **reset to its original position**.

Connect the controller to the PC via a USB A-B cable while **disconnected from the power supply**:

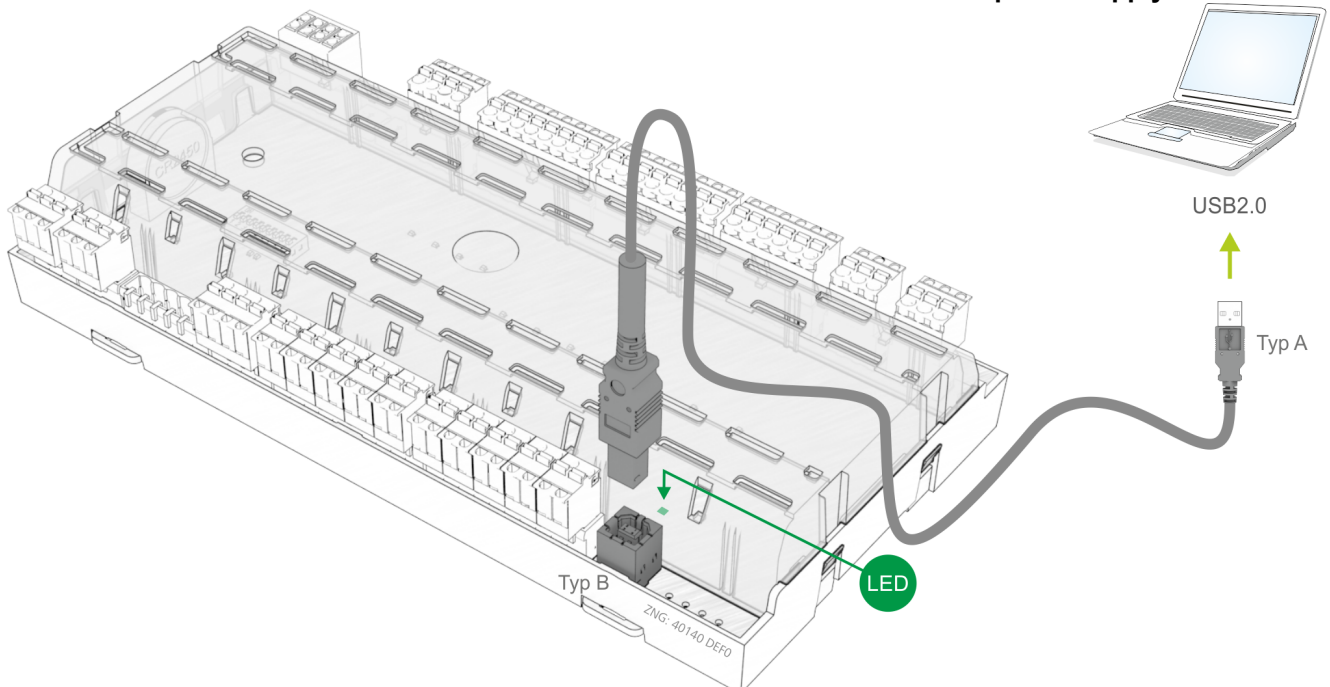

Then supply the controller with power again, see chapter [Terminal assignment for 230 V AC power supply](#).

Step 2: Driver installation

During the **first** connection of the controller to the PC, the "Scan for new hardware wizard" opens. Please follow the instructions of the wizard:

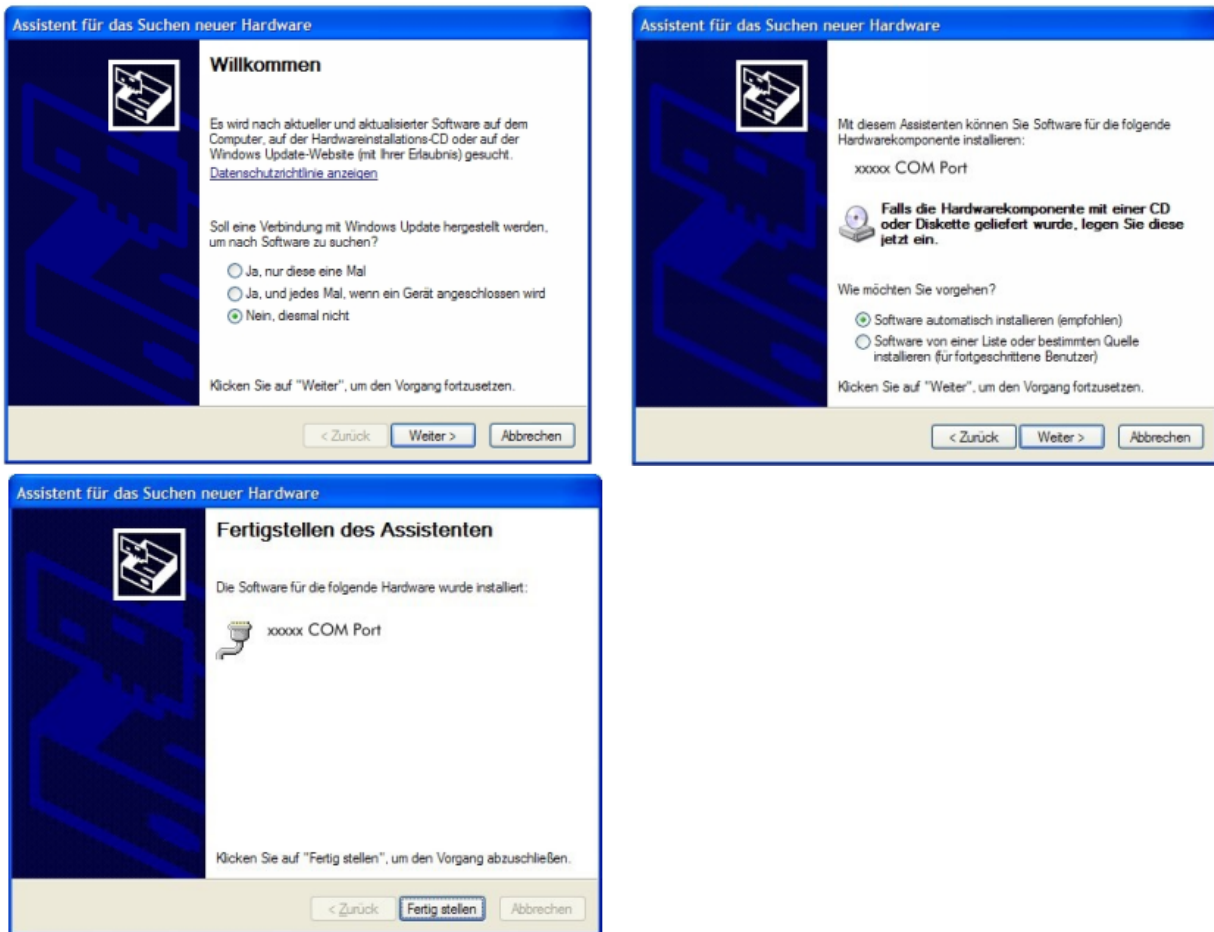

i No error message such as "USB device not found" should be displayed on the laptop or PC. Otherwise, tips for rectifying driver problems are explained in more detail in the chapter [Rectification of driver problems](#).

Step 3: Perform firmware installation

Under "Start / Programs / ECKELMANN / Firmware Uploader", start the program "KGL Firmware Uploader". The following window opens:

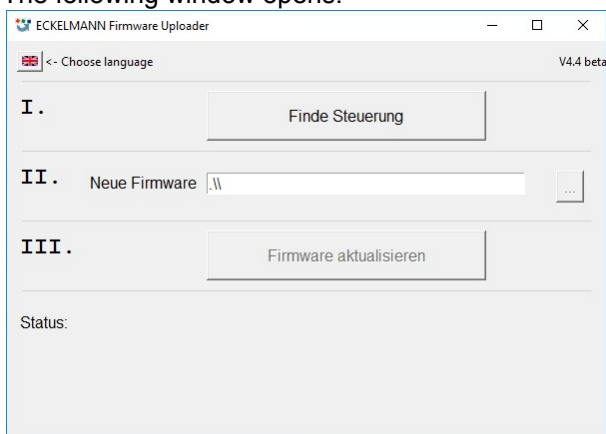

Click the "Find Controller" button to find the controller.

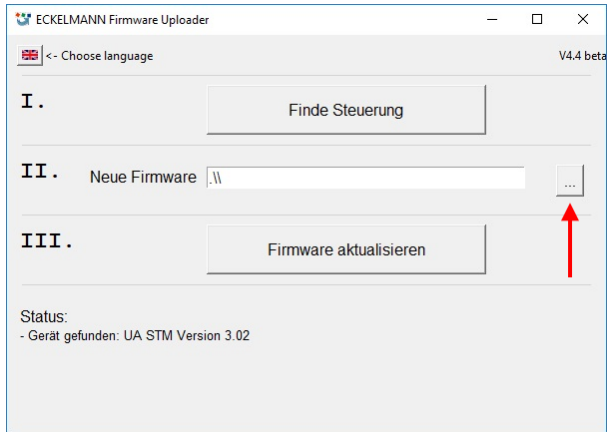

A notification is displayed in the status field if the controller has been found. Then select the current firmware file ("*xxx.bin*") from the directory into which the ZIP file was extracted (see arrow).

After the conversion, tap the button "Update firmware" to start the firmware upload:

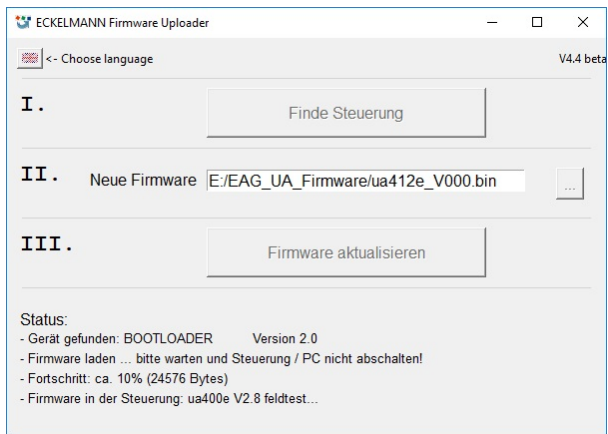

The program can be ended after the successful firmware update by closing the window.

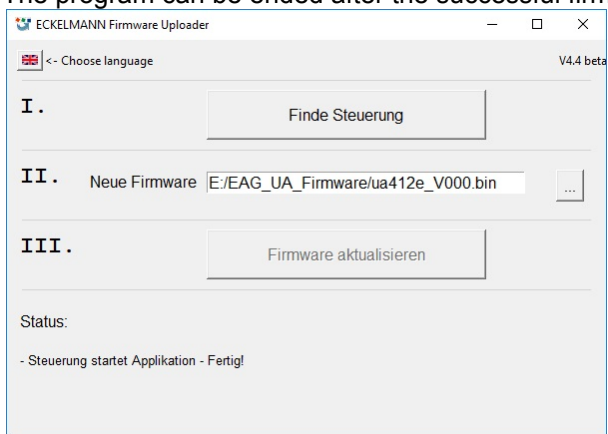

The USB A-B cable can now be disconnected from the controller.

Step 4: DIP switch S3 in original position again

After the firmware update has been performed, all coding switches 1..8 of the DIP switch S3 must be returned to their **original position**.

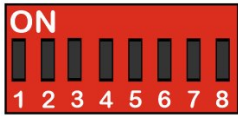

The settings depend on the controller type!

⚠ Risk of controller failure! The controller only accepts the settings for DIP switch S3 **after** the controller has been briefly disconnected from the power supply!

i After the firmware update, the saved settings can be reloaded into the case controller from LDSWin as required..

6.6.3 Rectification of driver problems

If the driver installation is not complete or if the controller has been accidentally connected to the PC before the execution of the installation program, the following instructions will provide you with information for how the problem can be rectified:

Problems with USB connections: Problems with the detection of controllers on the USB3 port may occur. Interconnection of a USB2 hub can be a possible approach for the solution. This usually enables Windows to detect the controllers:

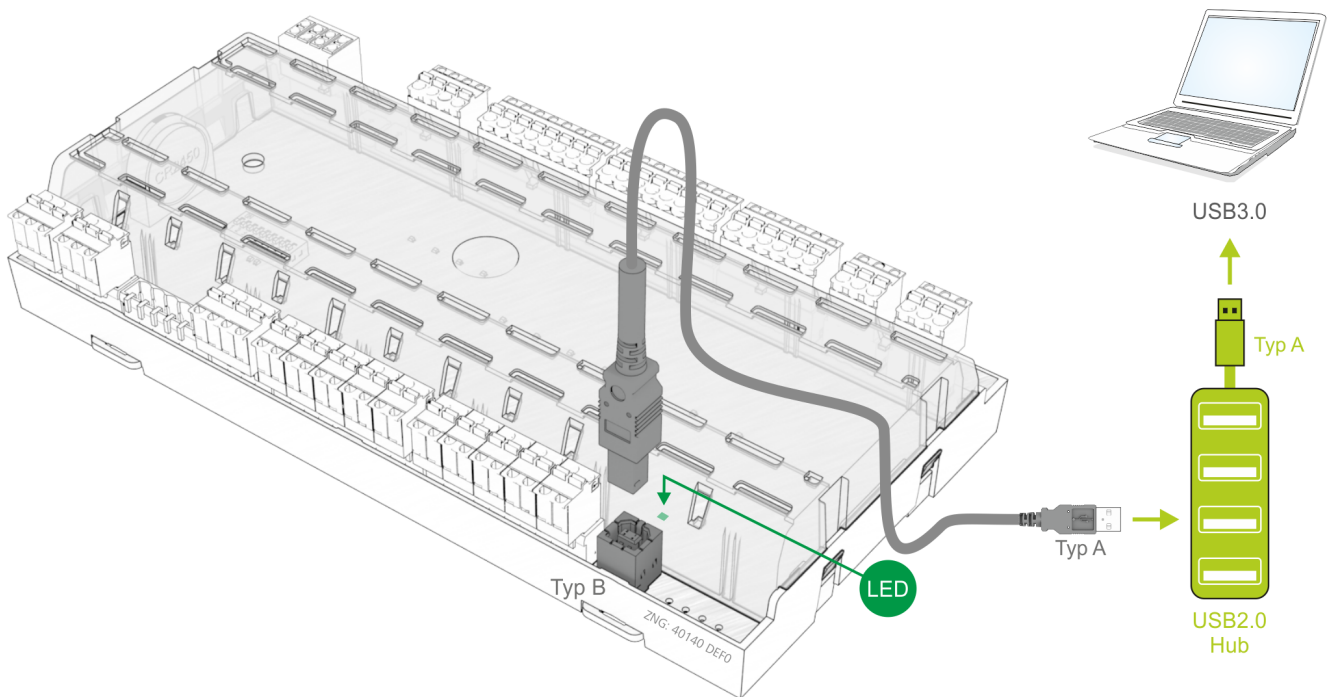

Windows XP / Vista: If the controller has been accidentally connected to the PC before the execution of the installer, the driver **must** be updated in the Control Panel.

For this, it must first be ensured that the installation program for the firmware upload has been executed: in the Start menu, call "Settings" - "Control Panel" - "Management" - "Computer Management" - "Device Manager" - "Ports (COM and LPT)" and using the right mouse button select the not correctly installed COM port ("UA 400 COM Port" or "WR 300 COM Port"). Then click on "Update Driver" and follow the instructions in the dialogue that opens; then the driver should be correctly installed.

Windows 7 / Windows 8 / Windows 10: Open "Control Panel", under "Device Manager" there, select "Ports (COM & LPT)". Then proceed as described above.

Special features under Windows 7/10: When executing the program, the request "Do you want to allow the following program from an unknown publisher to make changes to this computer?" must be confirmed with **YES**. If this request should be permanently suppressed, the following procedure is recommended:

In the directory "C:\Program Files\firmupl", click on the file "firmupl.exe" with the right mouse button. Select the entry "Allow" under "Properties" in the drop-down context menu. The request should no longer be displayed during the next start.

7 Pin and Terminal Assignments of UA 400

7.1 Terminal diagram

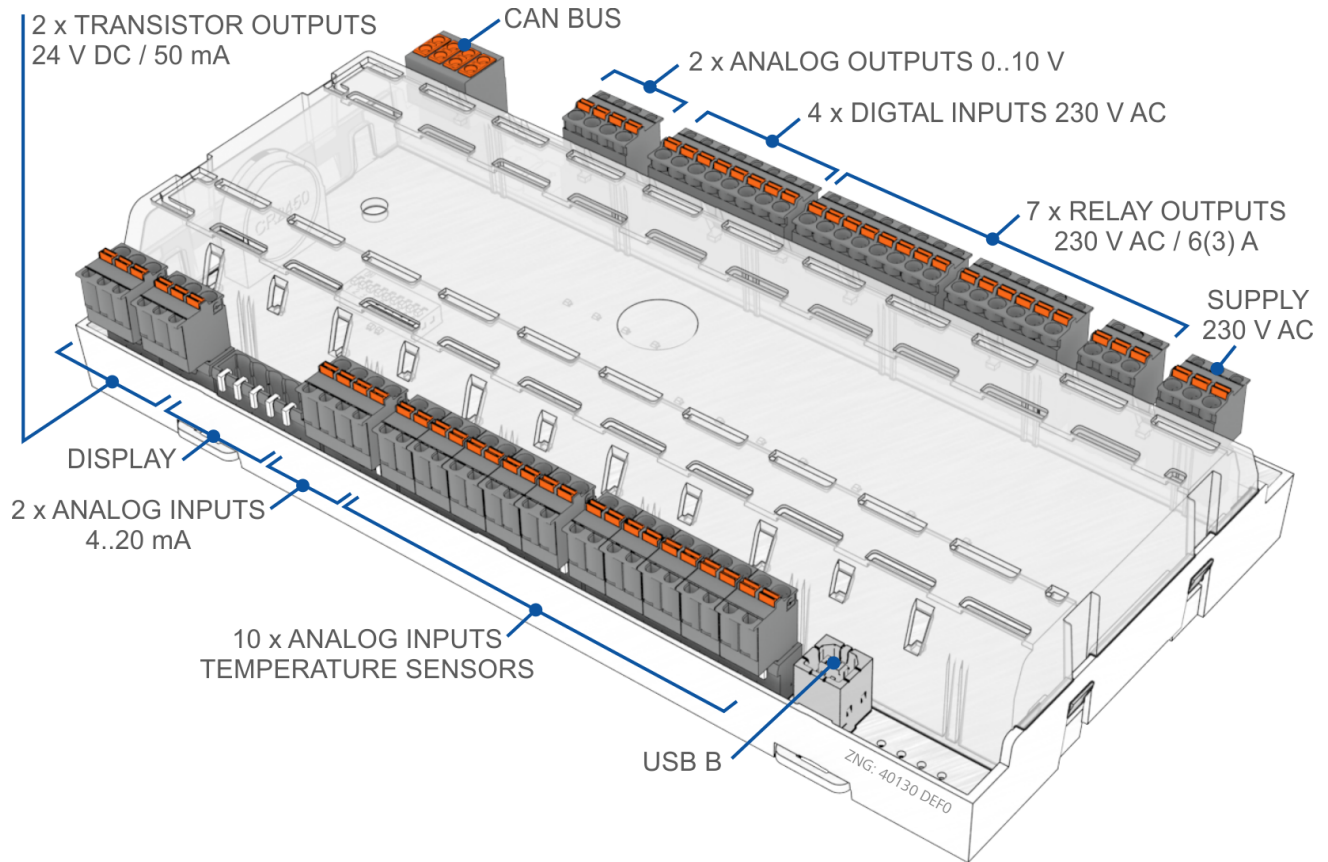

Connection diagram of the case controller with terminal designation, shown here in the UA 410 AC complete design.

Warning about dangerous electrical voltage! In order to guarantee reverse polarity protection, only coded mating connectors may be used on the control component connections.

The detailed description of the connection and terminal assignments is shown below.

7.2 Terminal assignment of the 230 V AC power supply

⚠ Warning about dangerous electrical voltage!
Danger of electric shock! BEFORE connecting and disconnecting, it must be checked that the 230 V AC power supply cable is **disconnected from the power supply!**

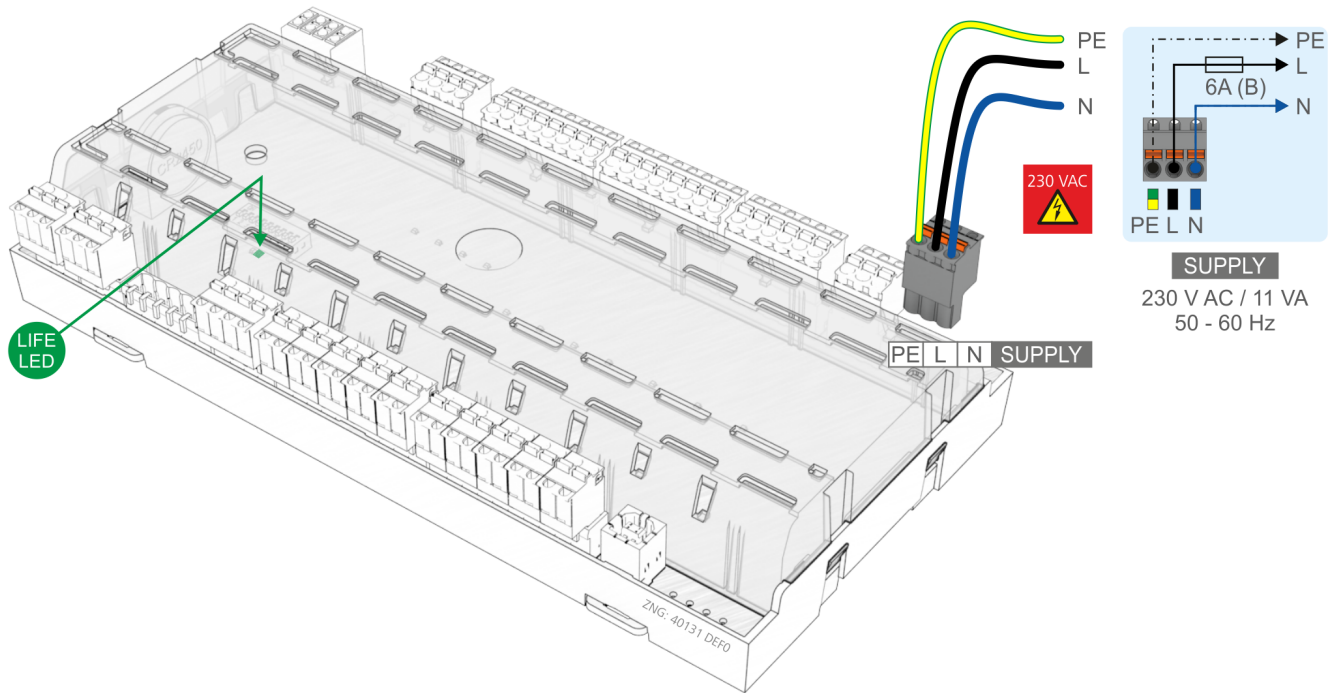

Controller type	Terminal No.	Description
All controllers	PE	Ground conductor
	L	Phase 230 V AC
	N	Neutral conductor

i After connection of the 230 V AC power supply, the green LIFE LED flashes, for details see chapter [Status LEDs](#)

7.3 Terminal assignment of the 230 V AC relay outputs

Warning - hazardous electrical voltage!
Danger of electric shock! BEFORE and AFTER connection it must be checked that the 230 V AC relay outputs are **off load!** Low voltage and safety extra-low voltage must **not** be applied together at the relay outputs.

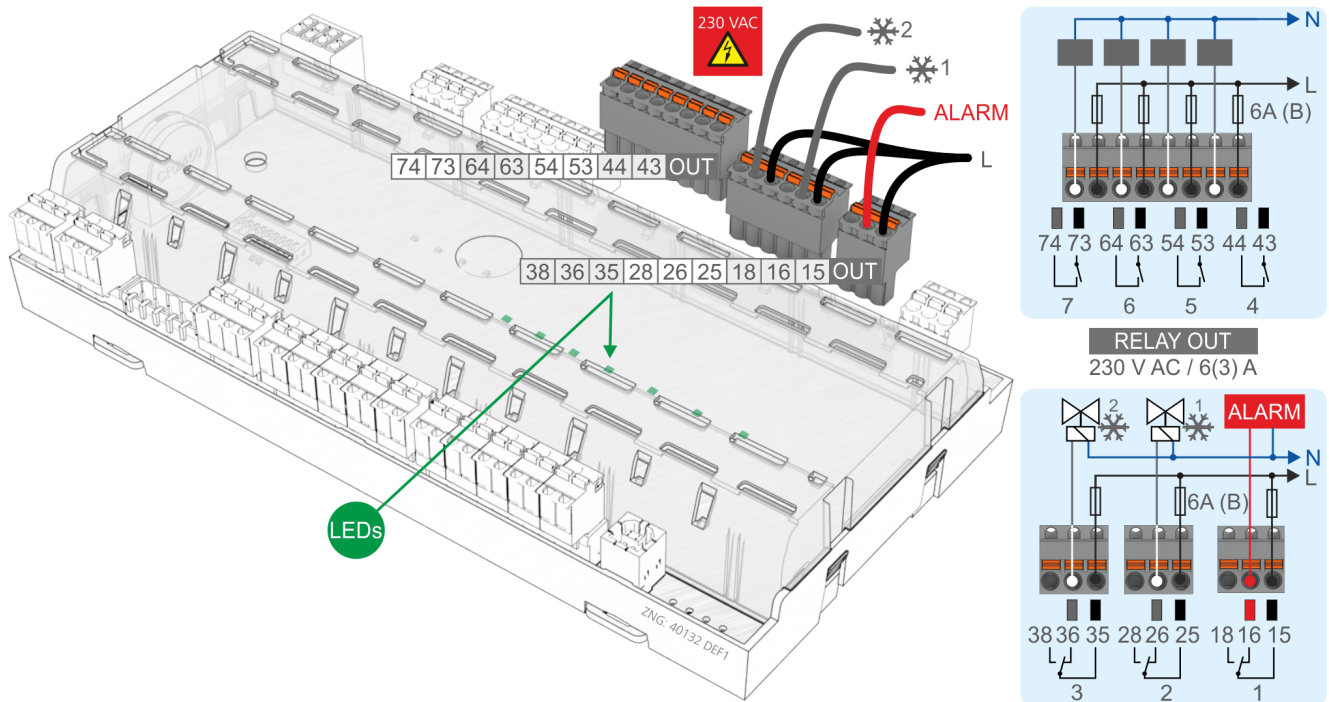

⚠ Fire hazard! On grounds of fire prevention, during the planning of the installation a device for shutting down the defrost heating in the event of excessive temperature (e.g. "KLIXON") must be provided.

	Relay 7	Relay 6	Relay 5	Relay 4	Relay 3	Relay 2	Relay 1
Controller type	74, 73	64, 63	54, 53	44, 43	38, 36, 35	28, 26, 25	18, 16, 15
Cold-room controller							
UA 111	Fan	Inv. Defrost	Defrost 2	Defrost 1	Cooling 2	Cooling 1	Alarm
UA 111 D	Fan	Inv. Defrost	–	Defrost 1	Cooling 2	Cooling 1	Alarm
UA 121	Fan	Inv. Defrost	Defrost 2	Defrost 1	Cooling 2	Cooling 1	Alarm
UA 131 Without fan control With fan control	Defrost 4 Inv. Fan	Defrost 3 Defrost 3	Defrost 2 Defrost 2	Defrost 1 Defrost 1	Cooling 2 Cooling 2	Cooling 1 Cooling 1	Alarm Alarm
UA 131 LS with advanced fan control	Defrost 4	Defrost 3	Defrost 2	Defrost 1	Cooling 2	Cooling 1	Fan
UA 131 DD	Defrost 4	Defrost 3	Defrost 2	Defrost 1	Cooling 2	Cooling 1	Fan
UA 141	Pane Heater	Inv. Defrost	Defrost 2	Defrost 1	Cooling 2/ Humidifier*	Cooling 1	Alarm
Case controller							
UR 141 NK (NT)	Fan 2	Fan 1	Defrost 2	Defrost 1	Cooling 2or Heating circuit*	Cooling 1	Alarm
UR 141 TK (LT)	Fan 2	Fan 1	Defrost 2	Defrost 1	Cooling 2or Heating circuit*	Cooling 1	Alarm

- In single zone operation only.

i If any relay output is activated by the controller, the associated green LED lights, see [chapter Status LEDs](#) for details.

7.4 Mode of operation of the relay and transistor outputs

The table shows operation of the outputs for the separate controller types.

Controller type	Relay outputs 230 V AC					Transistor outputs 24 V DC/50 mA (91/92)
	Fan (ventilator)	Defrosting	Cooling	Alarm	Relay for switch off	Frame/pane heater *
Case controller						
UA 111	inverted	positive	positive	inverted	–	inverted
UA 111 D	inverted	positive	positive	inverted	–	inverted
UA 121	inverted	positive	inverted	inverted	–	inverted
UA 131	–	positive	inverted	inverted	–	inverted
UA 131 LS with advanced fan control	inverted	positive	inverted	–	–	inverted
UA 131 DD	inverted	positive	inverted	–	–	inverted
UA 141	–	positive	positive	inverted	positive	positive (Relay 73/74)
Room controller						
UR 141 NK	positive	positive	positive	inverted	–	inverted
UR 141 TK	positive	positive	inverted	inverted	–	inverted

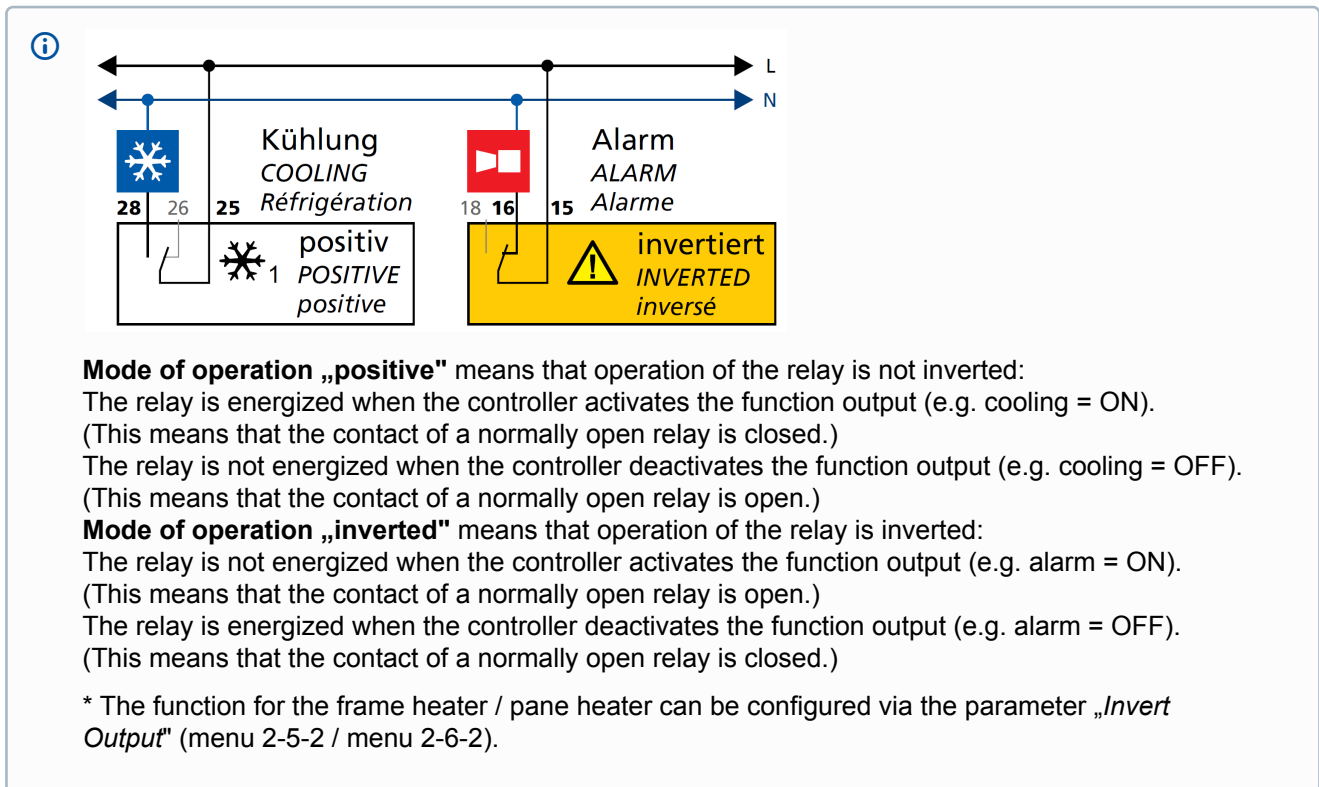

7.5 Terminal assignment of the 230 V AC digital inputs

⚠ Warning about dangerous electrical voltage!
Danger of electric shock! BEFORE connecting and disconnecting, it must be checked that **no voltage is present** at the 230 V AC digital inputs!

i The function of the digital inputs can be configured via the parameters *Inv. D1* to *Inv. D4* (menu 6-2-4). If multiple inputs have been parametrised with the same function, this function becomes active as soon as a 230 V signal is applied to one of these inputs. For further details see the appropriate chapter in the function description.

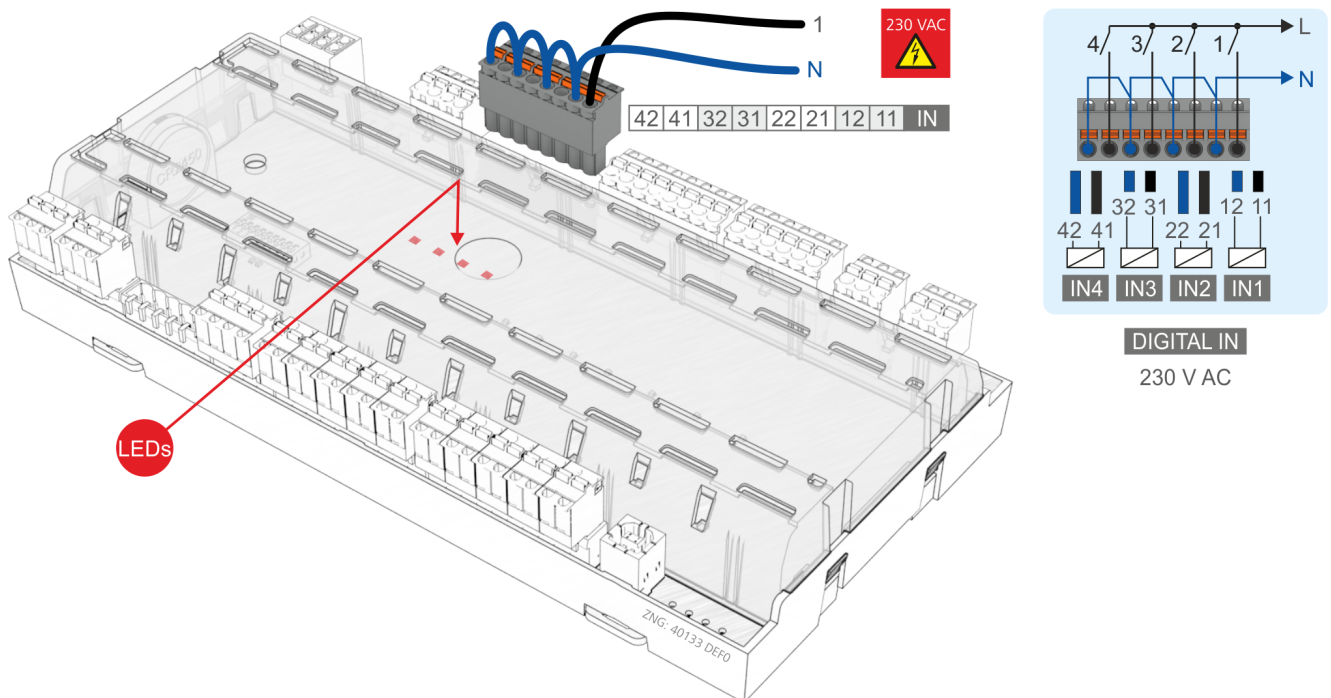

Controller type	D42/D41	D32/D31	D22/D21	D12/D11
Case controller				
UA 111, UA 111 D, UA 121, UA 131 UA 131 LS, UA 131 DD	<u>External alarm</u> ^{1) 2)} or Manual shutdown All / Manual shutdown Z1 / Manual shutdown Z2 / Toggle setpoint	<u>Manual shutdown All</u> ¹⁾ or Manual shutdown Z1 / Manual shutdown Z2	<u>Toggle setpoint</u> ¹⁾ or Manual shutdown All / Manual shutdown Z1 / Manual shutdown Z2	<u>Defrost</u> ¹⁾ or Manual shutdown All / Manual shutdown Z1 / Manual shutdown Z2 / Toggle setpoint
UA 141	<u>External alarm</u> ^{1) 2)} or Manual shutdown All / Manual shutdown Z1 / Manual shutdown Z2 / Toggle setpoint	<u>Pane button</u> ¹⁾ or Manual shutdown All / Manual shutdown Z1 / Manual shutdown Z2	<u>Toggle setpoint</u> ¹⁾ or Manual shutdown (All ¹⁾ / Z1 / Z2) / Shutdown button	<u>Defrost</u> ¹⁾ or Manual shutdown (All ¹⁾ / Z1 / Z2 / Toggle setpoint
Cold room controller				
UR 141 NK / UR 141 TK	<u>External alarm</u> ^{1) 2)} or Manual shutdown All / Manual shutdown Z1 / Manual shutdown Z2 / Toggle setpoint	<u>Cold room door 1</u> ¹⁾ or Manual shutdown All / Manual shutdown Z1 / Manual shutdown Z2	<u>Cold room door 2</u> ¹⁾ or Manual shutdown All / Manual shutdown Z1 / Manual shutdown Z2 / Toggle setpoint	<u>Defrost</u> ¹⁾ or Manual shutdown All / Manual shutdown Z1 / Manual shutdown Z2 / Toggle setpoint

¹⁾Factory setting²⁾ Freely configurable alarm text - factory setting is "CO2 Alarm"

 If a 230 V AC voltage is present at a digital input, the associated red LED lights. For details see chapter [Status LEDs](#)

7.6 Terminal assignment of the 0..10 V analogue outputs

Warning - hazardous electrical voltage! Connecting mains power to the analogue outputs will lead to the destruction of the controller!

Malfunctions due to interference sources: All leads running to and from the case controller must be shielded (cable type: LiYCY)! No shielding is required on sensor leads when installed exclusively inside the refrigerated display case and when external interference (for example from parallel power wires) is not to be expected (see operating instruction "Basics and General Safety and Connection Instructions"). As a general rule, care should be taken to ensure that signal leads and leads carrying a supply voltage are routed through separate cable channels.

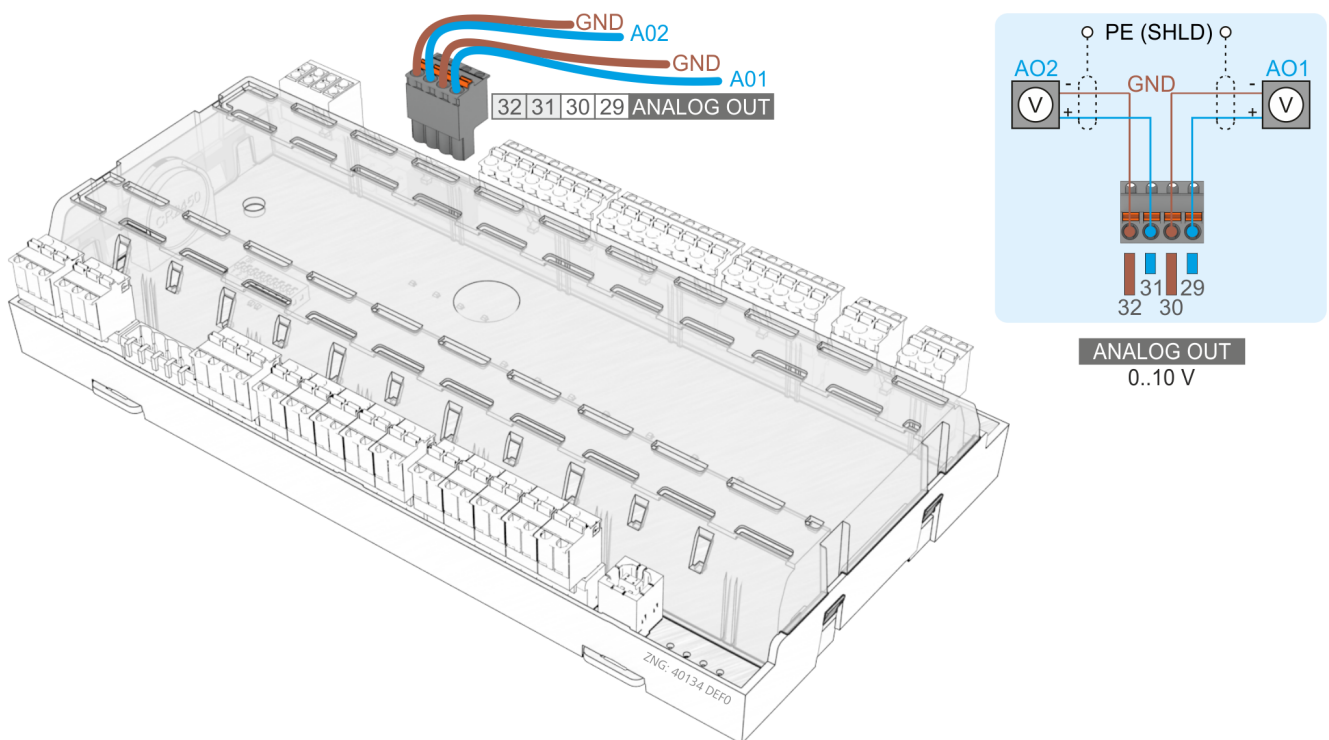

Controller Type	Terminal No.	Analogue output 2	Analogue output 1
All controllers	32	GND	–
	31	AO2 (+ 0..10 V) without function	–
	30	–	GND
	29	–	AO1 (+ 0..10 V) without function

7.7 Terminal assignment of the CAN bus terminals

⚠ Warning about dangerous electrical voltage!

If mains voltage is connected to the CAN bus terminals, this will result in the destruction of all components connected to the CAN bus!

ⓘ All supply lines from and to the case controller, particularly those of the CAN bus, must be shielded (cable type: LiYCY)! As a general rule, care should be taken to ensure that signal cables and cables carrying mains voltage are routed in separate cable channels.

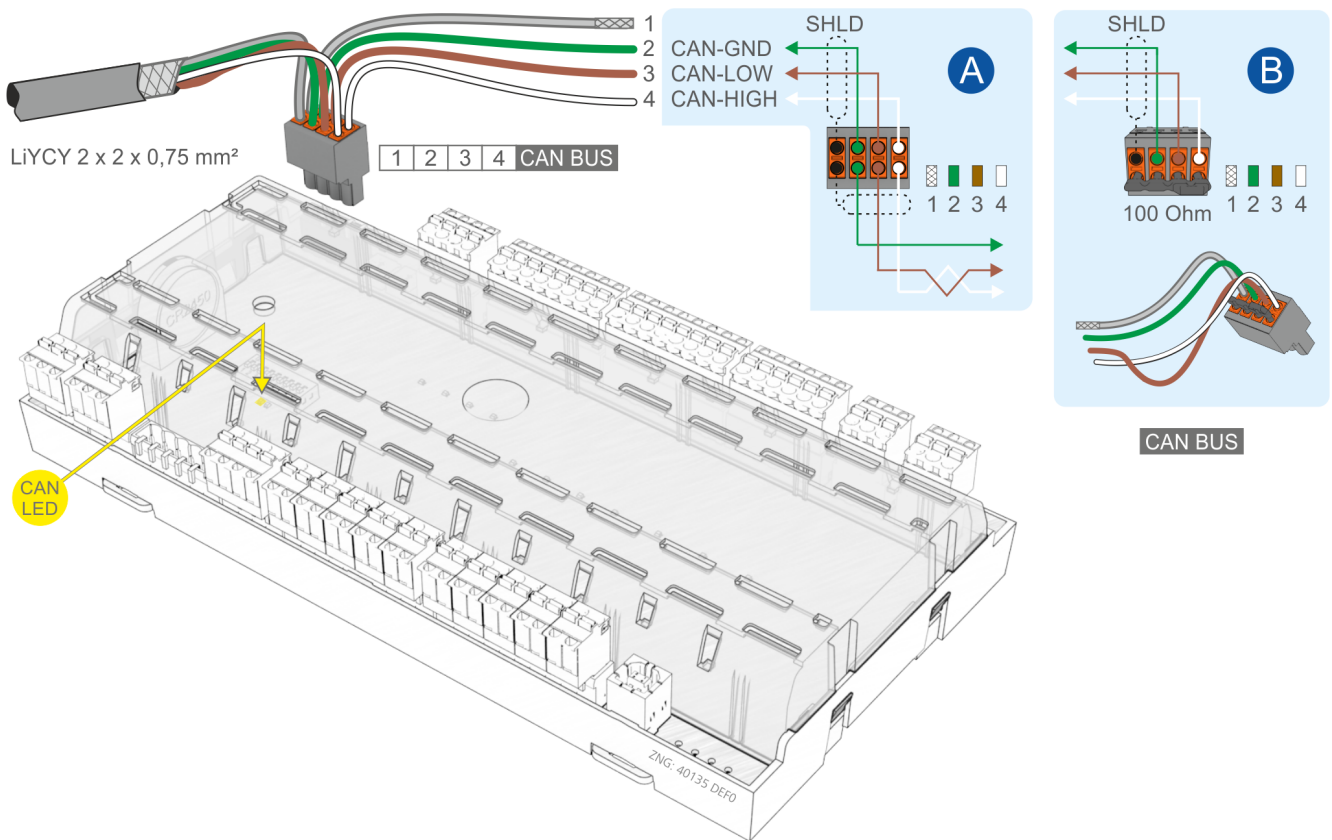

For further details about the setting of the CAN bus address see chapter [Setting the CAN bus address](#).

Controller type	Terminal No.	CAN bus	Wire colour
All controllers	1	Shield (SHLD)	Shield
	2	CAN-GND	green
	3	CAN-LOW	brown
	4	CAN-HIGH	white

ⓘ The orange CAN bus LED always flashes when data are being exchanged via the CAN bus with the system centre / store computer; see chapter [Status LEDs](#) for details.

7.8 Terminal assignment of the 24 V DC transistor outputs

⚠ Warning about dangerous electrical voltage!
If mains power is connected to the transistor outputs, this results in destruction of the controller!

⚠ Destruction of the transistor outputs! Due to the maximum capacity of 50 mA of the transistor outputs, 24 V DC coupling relays must be used for controlling the load.

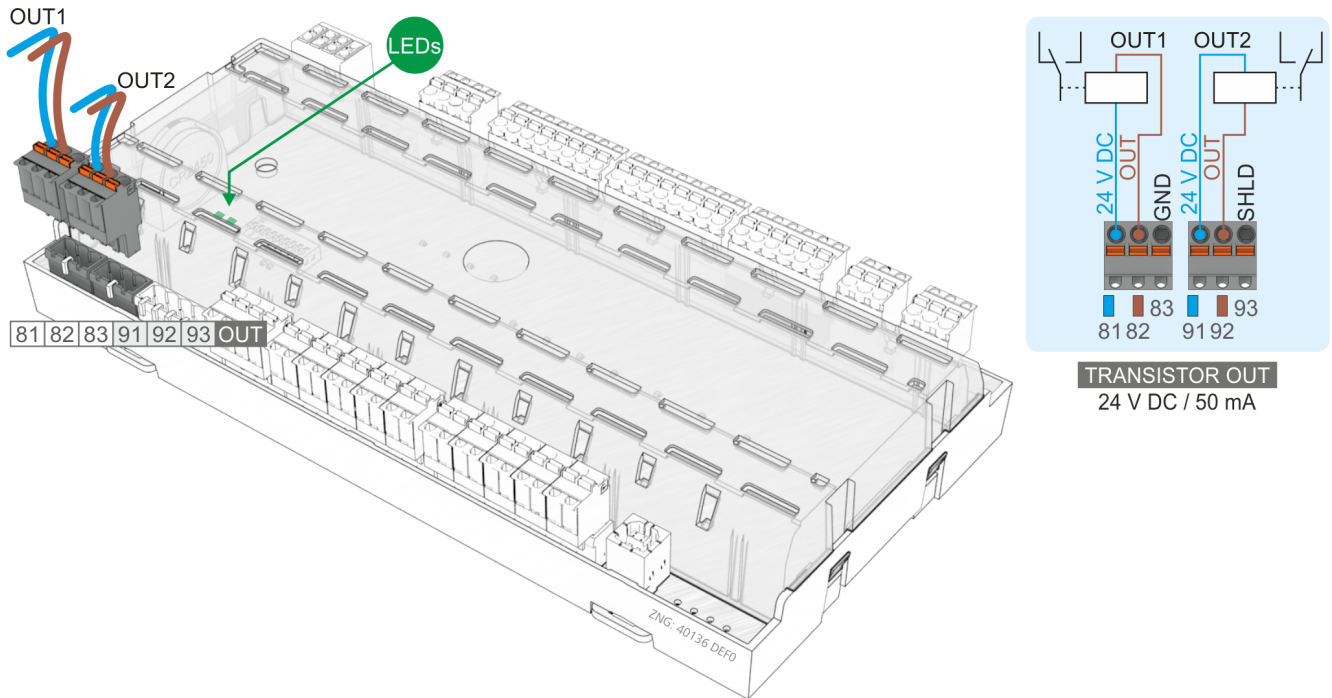

Controller type	Transistor output 1: 81: 24 V DC / max. 50 mA 82: OUT 83: GND	Transistor output 2: 91: 24 V DC / max. 50 mA 92: OUT 93: SHIELD
UA 111, UA 111 DUA 121, UA 131, UA 131 LS, UA 131 DDUR 141 NK, UR 141 TK	Lighting control (terminals 81/82)	Frame heater (terminals 91/92)
UA 141	Lighting control (terminals 81/82)	Control of external devices (terminals 91/92)

i If any transistor output is activated by the controller, the associated green LED lights; for details see chapter [Status LEDs](#). For further details about the function of the outputs, see chapter [Wirksinn der Relais- und Transistor-Ausgänge](#).

7.9 Terminal assignment of the DISPLAY interface

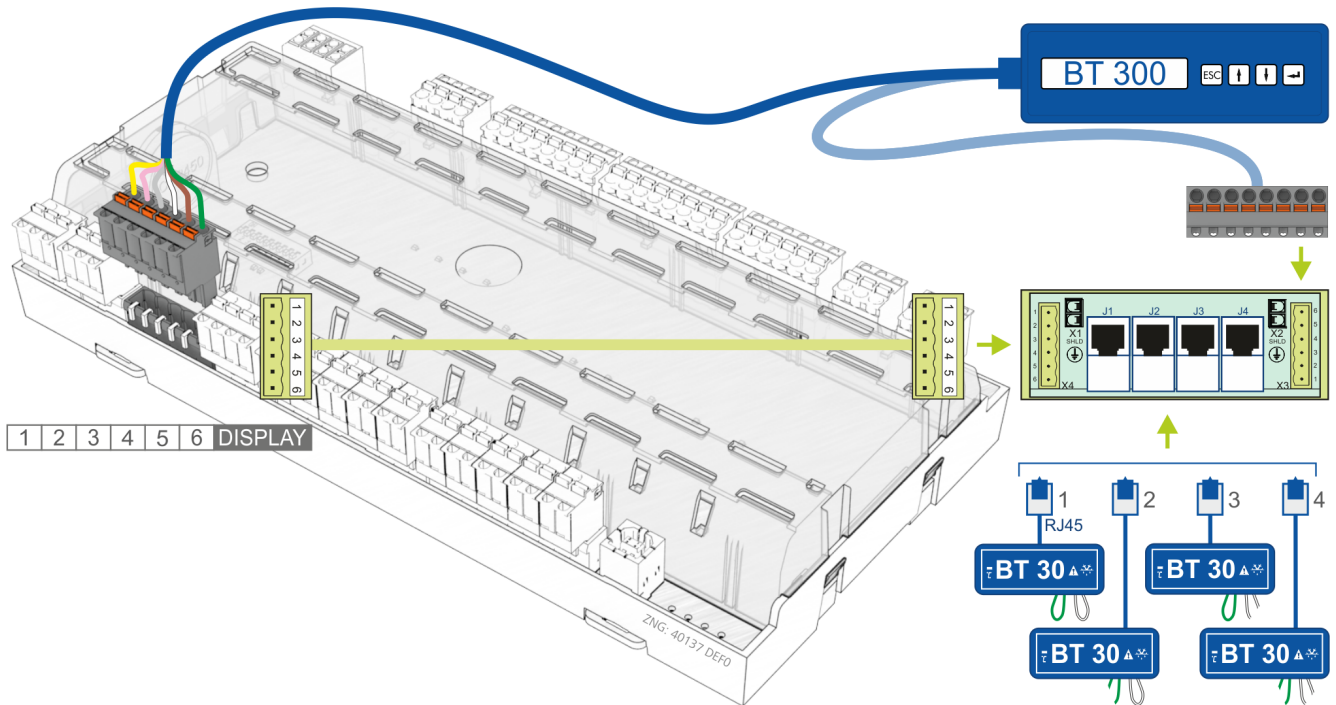

An operator interface of the BT 30 series (e.g. for service purposes) and/or up to four BT 30 temperature displays can be connected to the DISPLAY interface.

i For further details see chapter [BT 30 temperature display](#).

7.10 Terminal assignment of the 4..20 mA analogue inputs

⚠ Warning about dangerous electrical voltage! If mains power is connected to the analogue inputs, this results in destruction of the controller!

⚠ Malfunction due to interference! All supply lines from and to the case controller must be shielded (cable type: LiYCY)! If sensor cables are exclusively laid within the refrigerated case to be monitored and sources of interference (e.g. parallel power lines) are not anticipated, then it is possible to dispense with shielding. As a general rule, care should be taken to ensure that signal cables and cables carrying mains voltage are routed in separate cable channels.

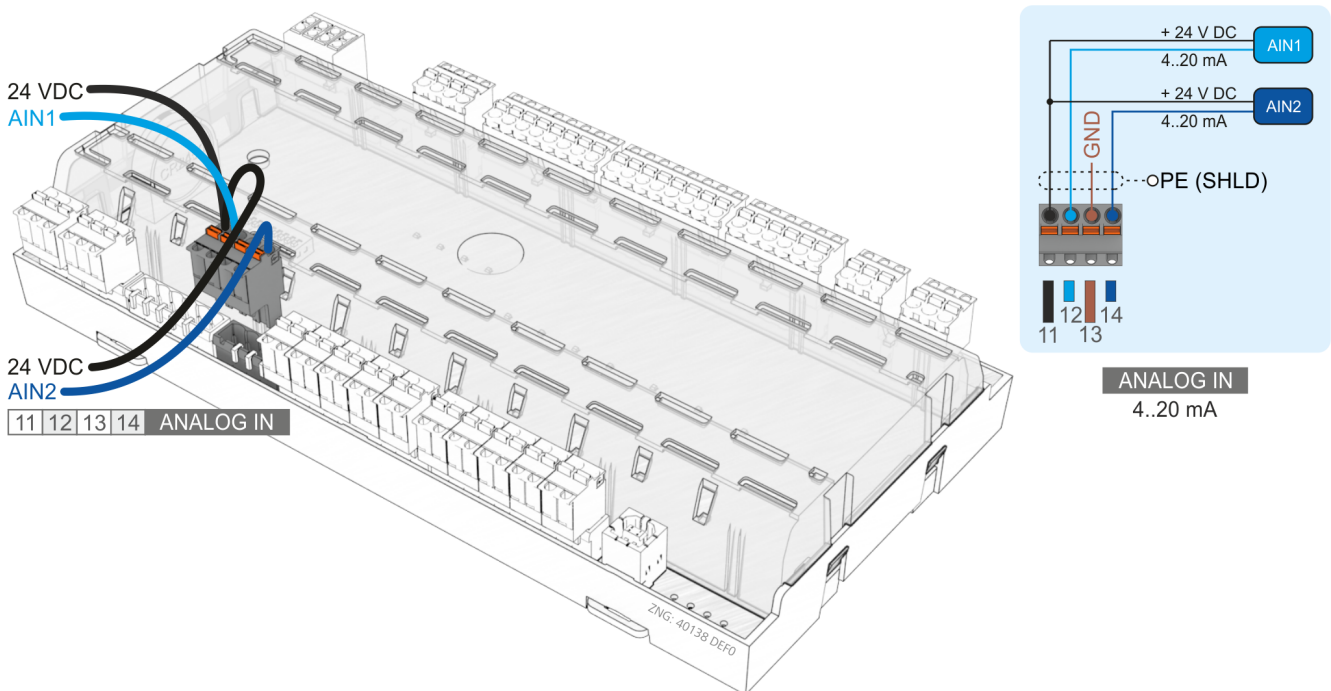

Connection of pressure transmitters / humidity sensors (only analogue input 2)

Controller type	Terminal No.	Analogue input AIN1	Analogue input AIN2
All controllers	11	+24 V DC	+24 V DC
	12	AIN1 (4..20 mA) sans fonction	–
	13	GND	GND
	14	–	AIN2 (4..20 mA) sans fonction

7.11 Terminal assignment of the analogue inputs for temperature sensors

Warning about dangerous electrical voltage! If mains power is connected to the analogue inputs, this results in destruction of the controller!

Malfunction due to interference! All supply lines from and to the case controller must be shielded (cable type: LiYCY)! If sensor cables are exclusively laid within the refrigerated case to be monitored and sources of interference (e.g. parallel power lines) are not anticipated, then it is possible to dispense with shielding. As a general rule, care should be taken to ensure that signal cables and cables carrying mains voltage are routed in separate cable channels. The case controller analogue inputs are **only** approved for the connection of temperature sensors as named in chapter [Auswahl des Fühlertyps](#).

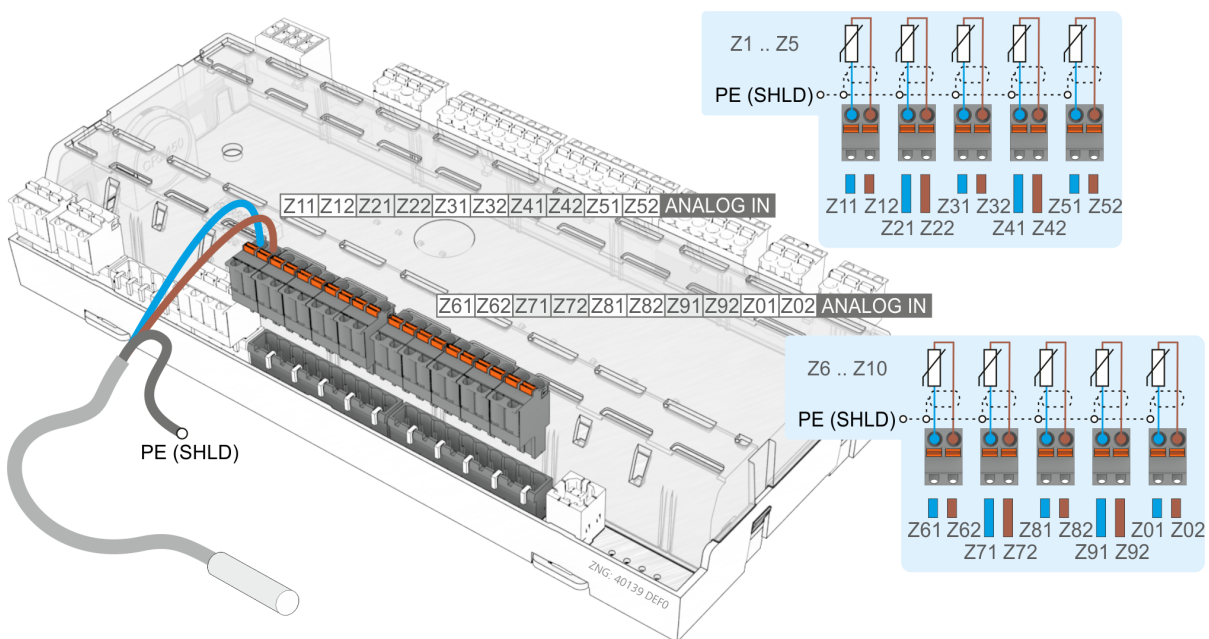

	Sensor 1	Sensor 2	Sensor 3	Sensor 4	Sensor 5	Sensor 6	Sensor 7	Sensor 8	Sensor 9	Sensor 10
Controller type	Z11/Z12	Z21/Z22	Z31/Z32	Z41/Z42	Z51/Z52	Z61/Z62	Z71/Z72	Z81/Z82	Z91/Z92	Z01/Z02
Case controller										
UA 111	R2.1	R4.1	R2.2	R4.2	R2.3	R4.3	R2.4	R4.4	–	–
UA 111 D	R2.1	R4.1	R2.2	R4.2	R2.3	R4.3	R2.4	R4.4	R2.5	R4.5
UA 121	R2.1	R4.1	R1.1	R4.2	R1.2	R2.3	R4.3	R1.3	R4.4	R1.4
UA 131 / UA 131 LS	R2.1	R4.1	R1.1	R4.2	R1.2	R2.3	R4.3	R1.3	R4.4	R1.4
UA 131 DD	R2.1	R4.1	R1.1	R4.2	R1.2	R2.3	R4.3	R1.3	R4.4	R1.4
UA 141	R2.1	R4.1	R2.2	R4.2	R2.3	R4.3	R2.4	R4.4	–	–

Eckelmann

Cold room controller										
UR 141 NK	R2.1	R4.1	R1.1	R4.2	R1.2	R2.3	R4.3	R1.3	R4.4	R1.4
UR 141 TK	R2.1	R4.1	R1.1	R4.2	R1.2	R2.3	R4.3	R1.3	R4.4	R1.4

7.11.1 Sensor identification

Legend: Ry.x		
y = Sensor type	1	Evaporator sensor (defrost sensor)
	2	Supply air sensor
	4	Return air sensor / room air sensor
x = Case part	1..5	Sensor element/coil 1..5

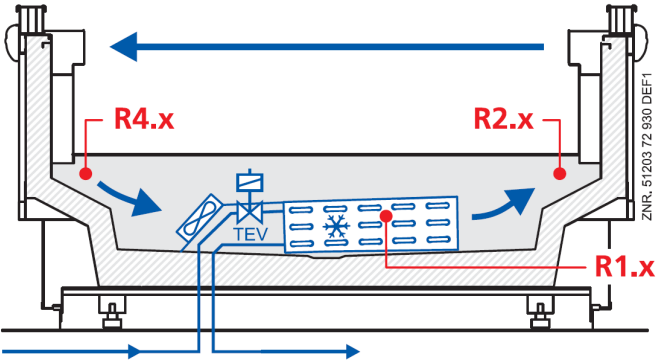

7.12 Assignment of the USB port

The USB port is used

1. for direct parametrisation of the case controller via LDSWin or
2. for performing a firmware update of the case controller or
3. for parametrisation of system components via CAN bus using LDSWin (USB2CAN). Furthermore, the operating data of the case controller can be read out via the USB port using a PC equipped with LDSWin.

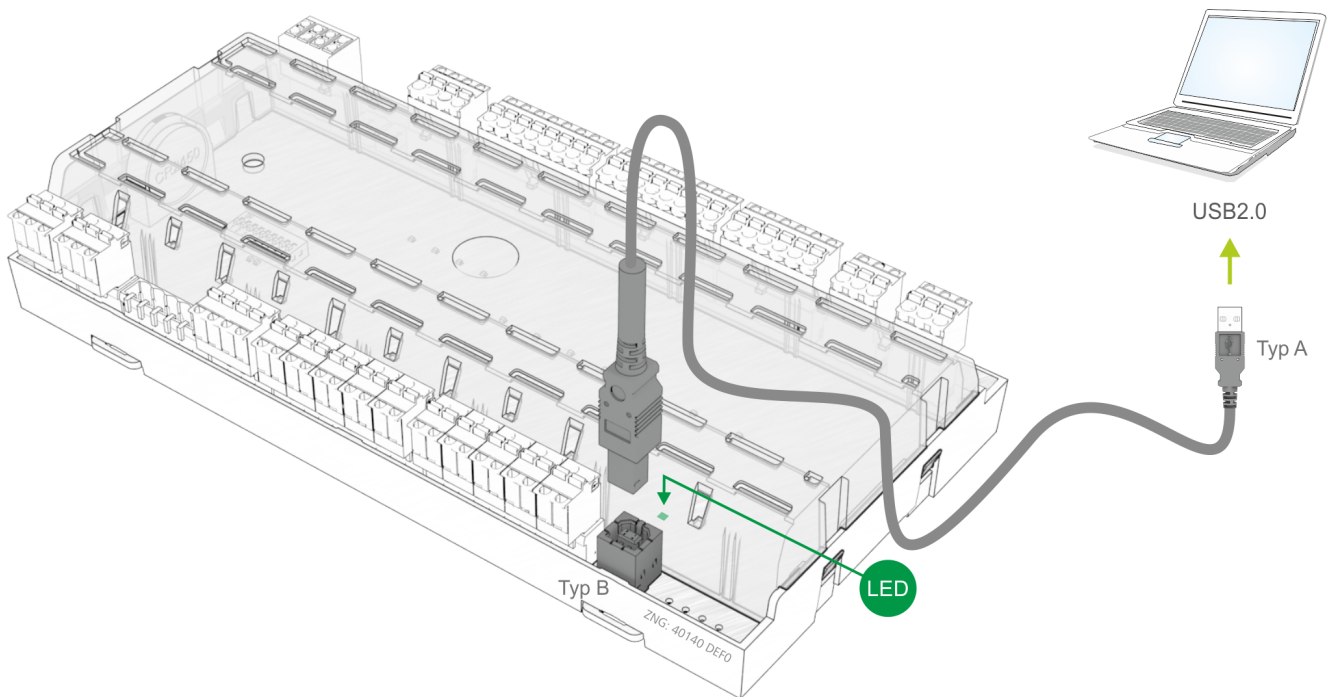

- i** If the controller is connected to a PC via USB, the green USB LED lights. For details see chapter [Status LEDs](#) A USB A-B cable (see [Zubehör](#)) is required for the connection to a PC. Refer to the LDSWin operating manual for further information about the connection to LDSWin. A detailed description of the firmware update is contained in chapter [Firmware Update](#).

7.13 Terminal assignment of the CI 320/TTY interface

The CI 320/TTY interface can be used for the following:

- A: Reading off the controller's operating data with the software LDSWin, or
- B: Integrating the case controller as replacement controller in the LDS legacy system:

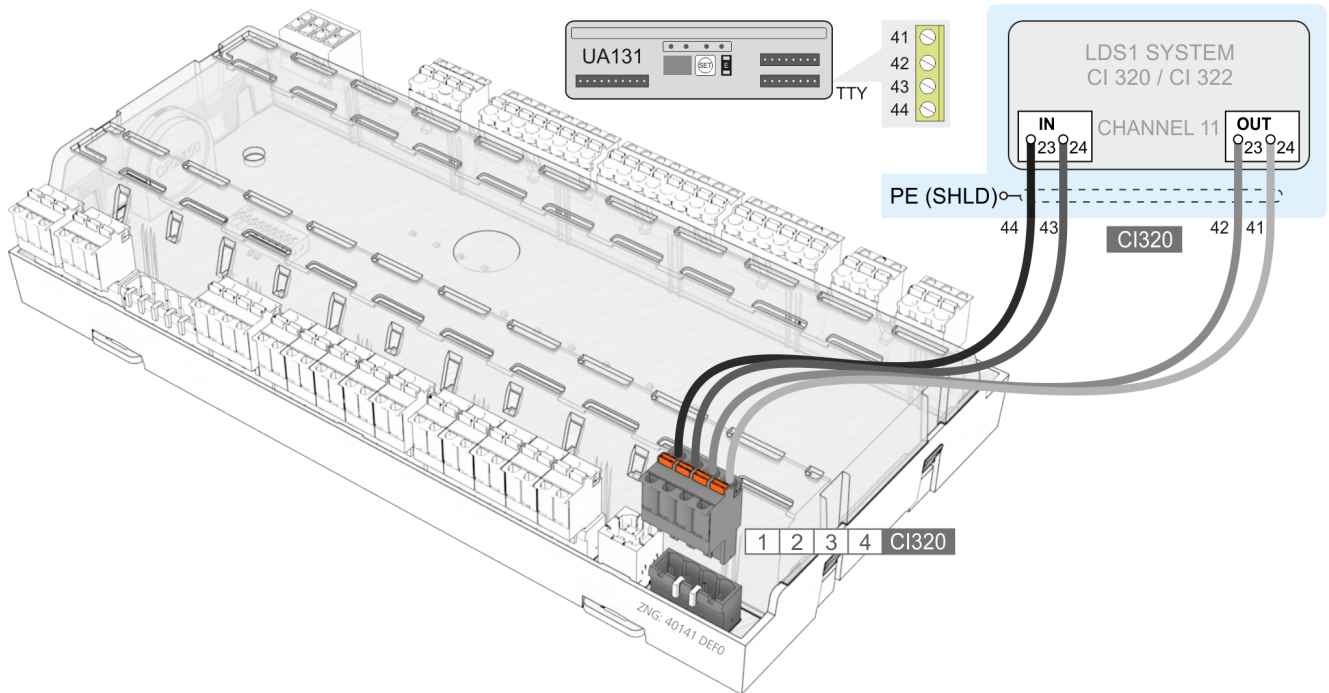

- i in order to read off operating data with LDSWin a TTY interface adaptor is required (optional accessory). For further information on the TTY connection see the LDSWin operating instruction. For the integration in the LDS legacy system, please consult the documentation "*Connection of a universal UA 300 case controller to the legacy system LDS 350*"; see https://edp.eckelmann.de/edp/lDs/_A3hQ1UvZac.

7.14 Wiring of the master-slave function for defrost synchronization

For defrost synchronization via wiring the auxiliary contactors of the master defrost relay are switched in parallel and then routed as a 230 V signal to the slave's external defrost input (terminals D11/D12). The auxiliary contactors of the slave controller are also connected in parallel and conducted back as a 230 V level to the external defrost input of the master. This enables the software to determine whether defrosting is still taking place in both case controllers.

Warning - hazardous electrical voltage!
Danger of electric shock! BEFORE and AFTER connection it must be checked that the 230 V AC digital inputs are off load!

i The description and operating instructions for the master-slave mode via wiring are contained in chapter [Brine defrosting](#).

Basic diagram for wiring between one master and **one** or **more** slave case/cold-room controllers:

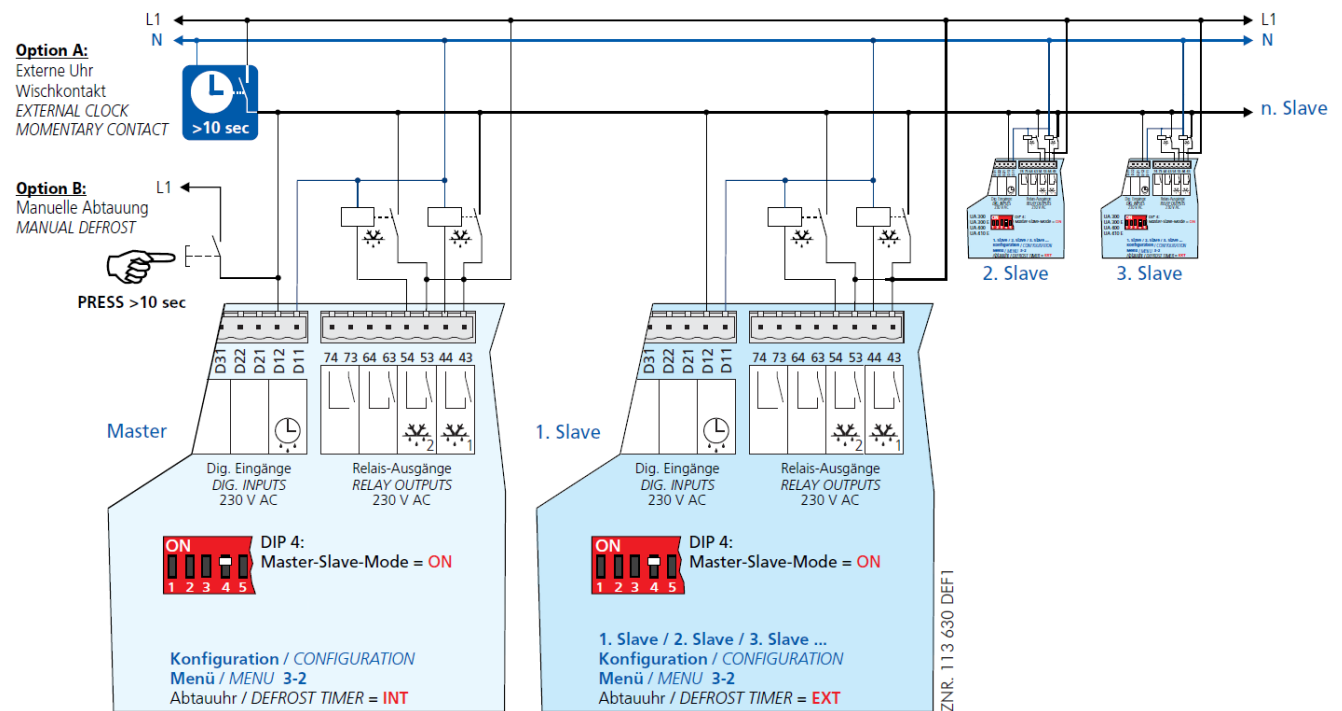

Danger of short circuit! When wiring master and slave case/cold-room controllers, make sure that power supply is made with only **one** phase (e.g. only through L1, see illustration)!

i Defrosting is terminated by the software not later than when the set safe defrost time expires. The external clock must be wired as a passing contact as it only provides the start signal for the defrosting. The shutdown is entirely managed by the participating controllers according to their safe defrost time.

8 Operation of UA 400

8.1 Operation possibilities

The controller provides menus and screens for the display and adjustment of values. However, no operation for this is provided on the controller itself. The actual operation of these menus is performed externally using the following possibilities:

- **Local operation with a BT 300 x operator interface:** The operation is performed directly on-site at the controller with an operator interface of the BT 300 series.

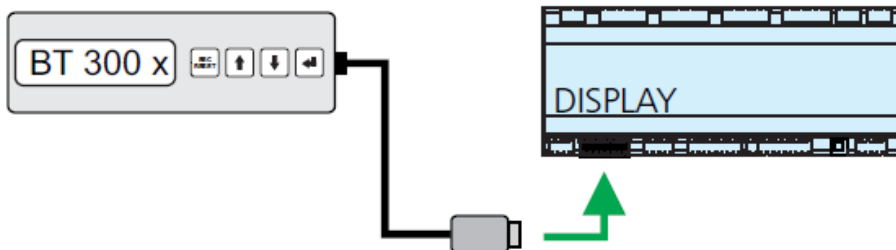

See chapter [Local operation with a BT 300 x operator interface](#) for details for the operation.

- **Remote control via the terminal:** The controller can be operated remotely (e.g. from the machine room) using the system centre, a store computer or an operator terminal. The communication with the controller is performed via the CAN bus

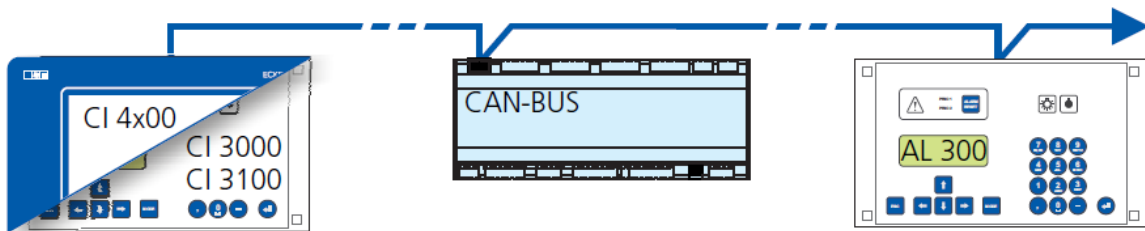

See chapter [Remote control via a terminal](#) for details for the operation.

- **Remote control with PC software LDSWin:** A PC with LDSWin installed is connected to the system centre or the store computer. The connection can be made here, for example, via the serial interface, a modem, a network or the PC-CAN bus adapter. In this way, the controller can be operated very conveniently with the PC software and its powerful functions such as controller analysis, evaluations, storing parameter sets, creating lists, etc.

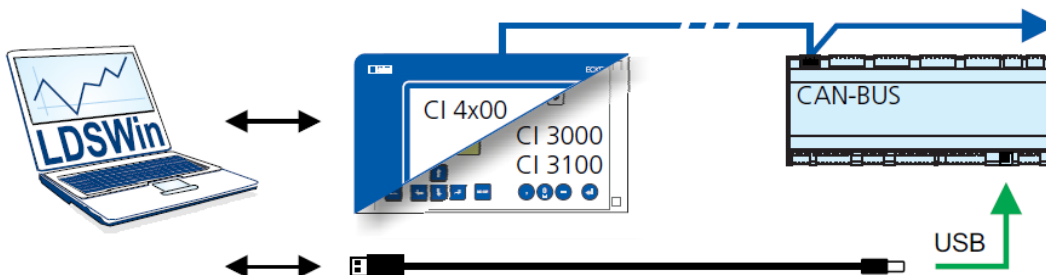

See the LDSWin operating instruction for details about the range of functions.

8.2 Local operation with a BT 300 x operator interface

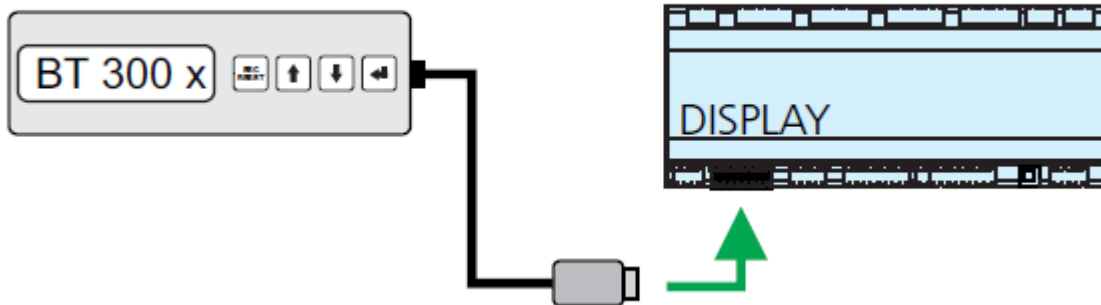

An operator interface in the BT 300 series is connected locally via the DISPLAY interface. Thereby, the controller can be operated standalone as shown or also connected to the CAN bus.

The operation here largely corresponds to the possibilities as described for the system centre, the store computer and the operator terminal; see chapter [Menus and operating screens](#) for details.

If no buttons are pressed, the display of the BT 300 x operator interface shows the name of the controller and its position designation. The **ENTER** button (↵) must be tapped to return from the display of the operating status back to the Operation menu.

- i Device-specific limitations arise due to the smaller display (only 2 rows x 20 characters) and fewer buttons as compared with the system centre, the store computer and operator terminal. Operation with a system centre, store computer, operator terminal or the PC software LDSWin provides more functional possibilities. Technical details about the operator interfaces can be found in their [Operating Manuals](#).

8.2.1 Lock-down of the setpoint change

The operator interfaces of the BT 300 series can be locked using a jumper on the circuit board so that all actual values, parameters, temperatures and statuses can be viewed, but so that it is no longer possible to adjust the setpoints of the respective controller.

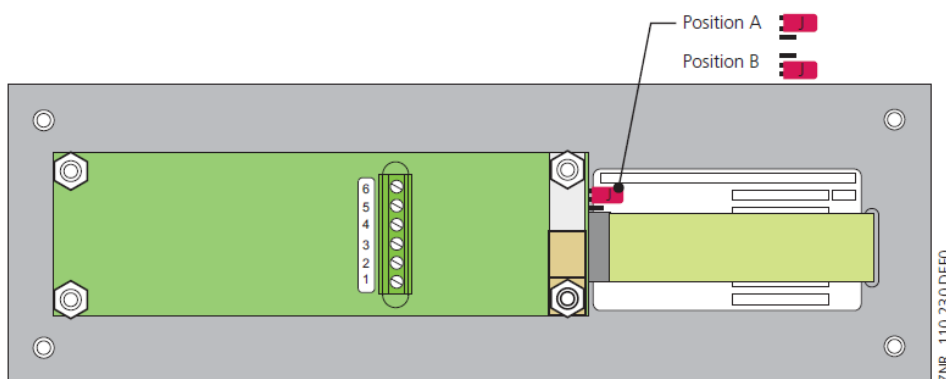

Jumper setting A: with setpoint change

Jumper setting B: without setpoint change

The operator interfaces are set to the jumper position A (with setpoint change) at the factory.

 If operator interfaces are mounted in areas accessible to the public, i.e. on serving counters for the sales personnel, the jumper position **B** should be selected (without setpoint change).

8.3 Remote control via a terminal

i Further details for the operation of a system centre, store computer or operator terminal can be found in their operating manuals.

For the remote control of a controller, it makes no difference whether this is done with a system centre (A), a store computer or with an operator terminal (B) as the user interfaces on the terminals are almost identical and the same functions are available. See chapter [Calling the controller menu via remote control](#) for details about remote control.

The system centre only emulates the "hardware front" of its "store computer" predecessor or of the operator terminal by software on its touchscreen which is demonstrated by the following comparison between the terminals of the CI 4x00 and CI 3x00 / AL 300:

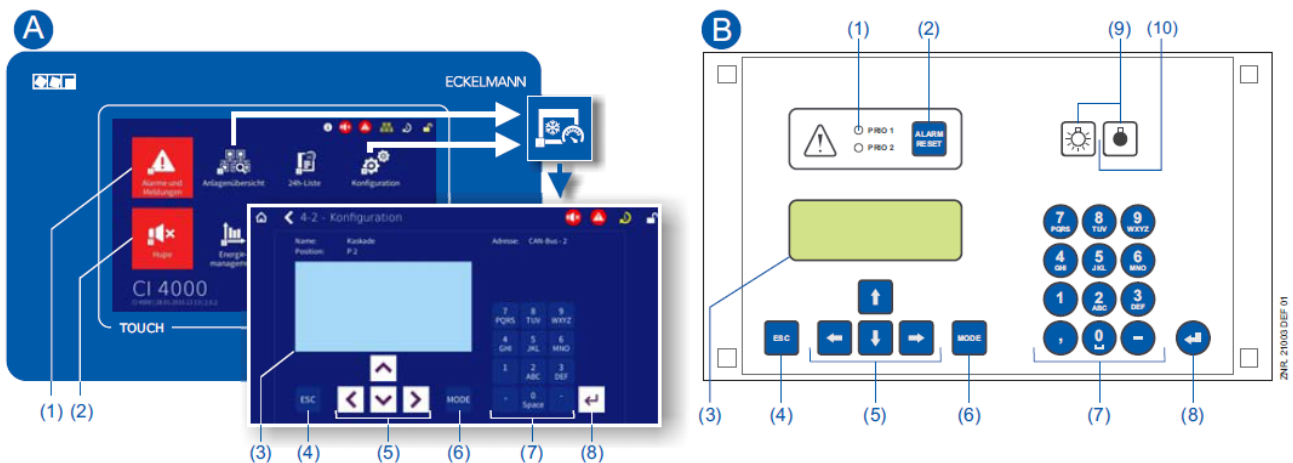

- (1) CI 4x00: "Alarms and messages" button in the main menu for display of whether alarms are pending. Alarms are acknowledged in the "alarm list". CI 3x00 / AL 300: Red LED signal lamps to indicate whether alarms are pending.
- (2) CI 4x00: "Horn" button in the main menu for muting of the buzzer and for reset of the AUX relay. CI 3x00 / AL 300: Button for muting of the buzzer, for reset of the AUX relay* and for acknowledgement of alarms.
- (3) Display (4 lines x 20 characters) for display of the menu of the controller.
- (4) **ESC** button
- (5) Cursor buttons
- (6) **MODE** button for, e.g. toggle upper case / lower case for text input.
- (7) Alphanumeric keypad
- (8) **ENTER** button (↵)
- Only CI 3x00 / AL 300:**
- (9) On/Off button for, e.g. lighting
- (10) Green LED signal lamp for status indicator whether the button is activated (then green) or deactivated.

8.3.1 Menus and operating screens

- i If the system centre, store computer or operator terminal remain locked down, settings on the controller are read-only. Changes and inputs are not possible. However, if any parametrisation is required, the lock-down for the input must be removed first, see chapter [Lock-down of the setpoint change](#).

Numbering of menus and screens:

Every menu in the menu tree can be reached using a specific number and every operating screen in a menu can be reached using a specific selection in the menu. This is identified in the operating manual by a unique identifier of digits (and letters if necessary) in the menu tree (e.g. Menu 3-1-2-a). Thereby, the digits 1, 2, .. stand for the identification of the corresponding menu, and the letters a, b, .. stand for the sequence of the corresponding operating screens in the menu.

Example for the numbering of a menu / screen

Any reference to, for example Menu 3-1-2 in the operating manual means that the required menu of the E*LDS component is called by entering the digits or selection of "3 - 1 - 2" via the remote control in the system centre, store computer or operator interface. The menu item "Remote control" is the interface for the E*LDS controller; see chapter [Calling the controller menu via remote control](#) for details.

If any letter is appended (e.g. Menu 3-1-2-a), this means that another submenu (operating screen or selection list) can be reached using the cursor right button (→). The letters indicate their sequence in the screen.

If any menu or operating screen consists of more lines than are possible in the display, scrolling is possible using the cursor buttons (↑) and (↓).

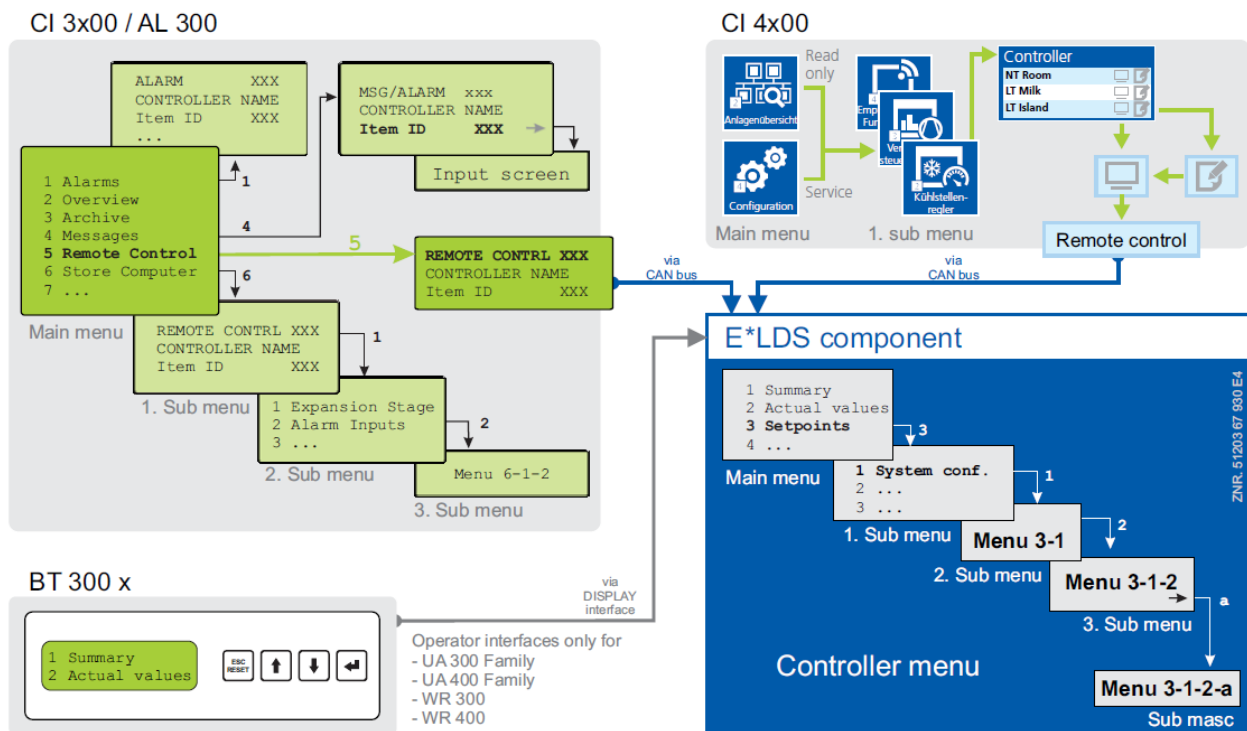

- i In contrast to the system centre, store computer or operator terminal, the menu of the controller is displayed directly on the operator interface.

Menus

A menu can contain up to ten menu items (0 .. 9; 0 for menu item 10). After the selection of a menu item using the cursor buttons (↑) and (↓) and by tapping the **ENTER** button (↵) or by tapping the buttons 0..9), other submenus or operating screens are displayed.

Selection of the menu items

Each line of this selection list in the display has a digit between 1 and 9 and 0 for menu item 10 with the associated name of the corresponding menu item. The various menu items can be selected directly by tapping the digit buttons 0 .. 9.

If a menu provides more than 3 submenus, the cursor buttons (⬅↑) and (↓) can be used for paging in the menu to display the remaining menu items.

- i** A menu item can be selected by pressing the respective numeric key regardless of whether the item itself is visible on the display.

Screens

An operating screen shows values for output and/or input. There may be more values for output and/or input than fit into the display at one time. The cursor keys can be used to scroll through these additional values. The screen may also contain more than one page, in which case the pages can be viewed one at a time.

- i** Arrows appear on the right of the display to indicate whether you can scroll or page through a menu or screen.

Scrolling

Using the cursor buttons (⬅↑) and (⬅↓)

- scrolling can be line by line, e.g. for selection of a variable in a line from a list of predefined variables.
- scrolling can be block by block so that values can be shown that cannot be displayed with the others due to the limited capacity of the display

Paging

If an operating screen contains multiple pages (e.g. the alarm list), these can be paged through using the cursor buttons (⬅←) and (→). In menus that provide more than 3 submenus, these can be paged through using the cursor buttons (↑) and (⬅↓) to display the remaining menu items.

MODE + 9 three lines upwards and

MODE + 3 three lines downwards

Eckelmann

Input of values and text

Select the required line using the cursor buttons (↑) and (↓) and then tap the ENTER button (↵). The cursor jumps to the input field. Values can now be entered and changed using the cursor buttons (↑) and (↓) or digit buttons.

If the cursor buttons (↑) and (↓) are kept pressed, the adjustment is made in high speed mode.

Deleting input text

The **MODE** button and - must be pressed simultaneously to delete the complete text line. A character is deleted using the button combination **MODE** and , .

Cancelling of an entry

The entry of a value can be cancelled by tapping the **ESC** button. The value is not applied.

Entering text

In fields that allow text entry, text can also be entered by the alphanumeric keypad. Repeatedly press the numeric keys to generate letters. Press the ENTER key (↵) to confirm the entered value or text.

Key	Letter/Character
0	äöüß0, space character
1	1
2	2ABC
3	3DEF
4	4GHI
5	5JKL
6	6MNO
7	7PQRS
8	8TUV
9	9WXYZ
-	. _ -
,	Insert space character



Eckelmann

 Upper case and lower case can be toggled by tapping the **MODE** button

Exit from the menus and operating screens

Press the **ESC** key to exit the menu or screen you are in at any time. This returns you to the next higher menu. All menus and screens are closed automatically if no key is pressed for 10 minutes. The display then jumps to the Main Menu or to the Alarm menu if any fault report is currently active (only CI 3x00 / AL 300).

8.3.2 Calling the controller menu via remote control

- ❗ If the system centre, store computer or operator terminal remains locked down, settings on the controller are read-only. Changes and inputs are not possible.

However, if any parametrisation is required, the lock-down for the input must be removed, see chapter [Lock-down of the setpoint change](#).

Tip: Detailed descriptions for the basic configuration of the controller and its position designation or about the settings of important parameters can be found in chapter [Basic configuration of the controller](#).

8.3.2.1 System Centre

The terminal for remote control of the controller (Menu 2-2 or Menu 4-2) is called in the system centre as follows:

Step 1: Tap "2 - System overview" or "4 - Configuration" in the main menu. If "2" is selected, the values below are only displayed as read-only, for "4", lock-down must previously be removed by logging in ([Deactivating the input lock-down](#)) so that settings below can be made.

Step 2: Tap "2 Case controllers" and select the required controller in the list that is then displayed using the cursor buttons (↑) and (↓). In the screen that opens, the name, position designation and the alarm priority of the controller can be input as required.

Step 3: The main menu of the controller is then displayed by tapping the "Remote control" button:

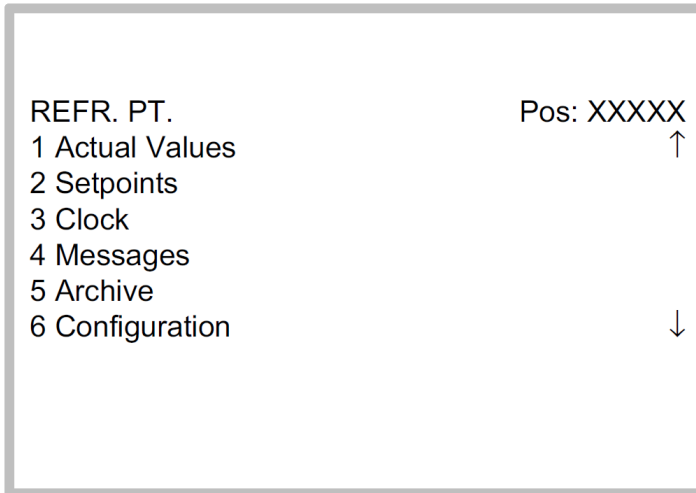

8.3.2.2 Store computer CI 3x00 / operator terminal AL 300

The main menu of the controller is called in the store computer or operator terminal as follows:

Step 1: Select the submenu "5 Remote control" in the main menu (see graphic).

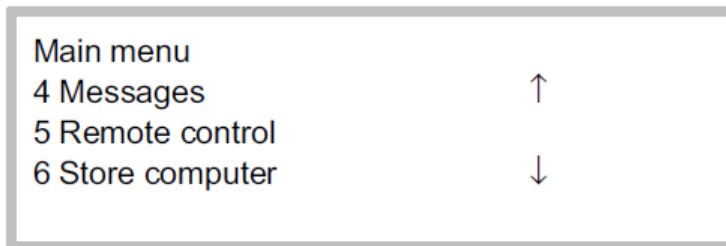

Step 2: Select the required controller using the cursor buttons (↑) and (↓) or by input of the CAN bus address (node number nnn) using the digit buttons. Thereby, the following screen is displayed:



Eckelmann

Step 3: The main menu of the controller is then displayed in the terminal by tapping the ENTER button

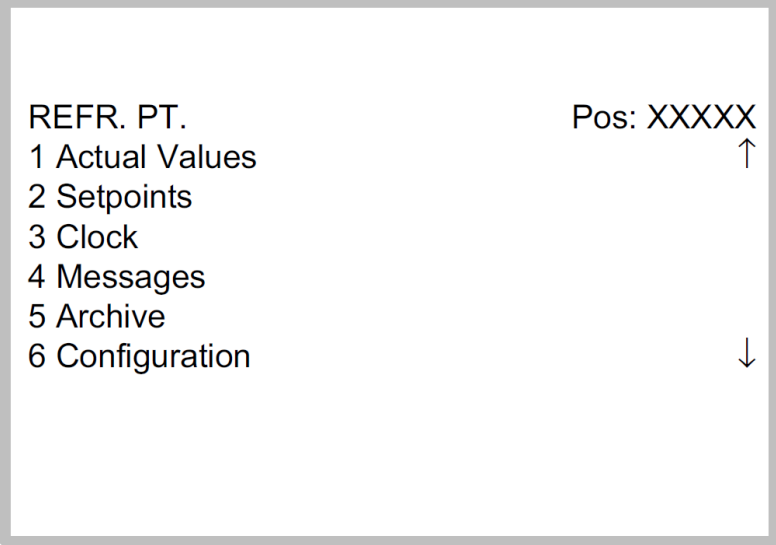

8.3.3 Deactivating the input lock-down

Operation via system centre, store computer or operator terminal is only possible for controllers with CAN bus connection; the removal of the lock-down is then applicable for all components in the CAN bus system. The lock-down is automatically reactivated 15 minutes after the last button tap.

 The release of the lock-down must only be carried out by service personnel.

Before entering values, the input lock-down must be removed as follows:

8.3.3.1 Store computer CI 3x00 / operator terminal AL 300

Before entering values, the input lock must be removed from the store computer or operator terminal as follows:

Step 1: Select menu item 9 "Parametrisation" in the main menu.

Step 2: Select menu item 3 "Lock-down" in this menu.

Step 3:

A. Unlocking store computer (standard) Tap the ENTER button (↵) to set the marker (✓). The lock-down has now been deactivated and it is possible to make settings.

or

B. Unlocking store computer and activating Superuser mode (Superuser permissions) Input current date backwards (nothing is shown on the display). Example: The current date is April 17, 2016, i.e. 17/04/16; the required input for enabling Superuser permissions is then 614071. Confirm the input with the **ENTER** button (↵); an **"S"** is shown on the display.

Step 4: Exit the operating screen and return to the main menu by tapping the **ESC** button twice.

 **Tip:** If you are already in the user interface of a CAN bus node but have forgotten to release the input lock-down, you can unlock the input lock-down for this controller using the button combination **MODE** and the input lock-down is active again as soon as you exit the user interface of the controller.

8.3.3.2 System centre CI 4x00

Login to and logout (unlock and lock-down) of the system centre:

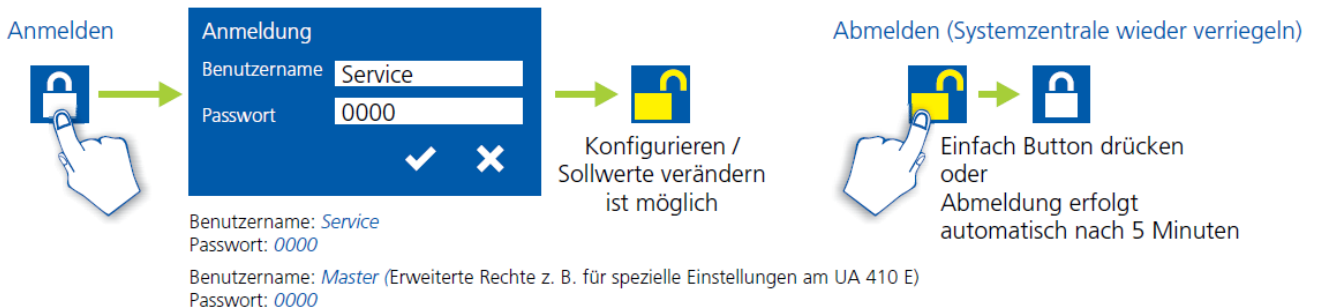

8.3.4 Activating service mode

For repair and maintenance work, service personnel can deactivate the remote alarm function of the system centre and of the store computer for a limited period using the service mode.

- i** The activation of the service mode must only be carried out by service personnel. If there are still pending alarms (with the priority 1..2) after the time of the Service Mode has elapsed, the audible warning devices and the alarm relays are activated and the alarms are forwarded using the automatic transmission of alarms.

8.3.4.1 System centre CI 4x00 Service-Mode

Activating/deactivating service mode

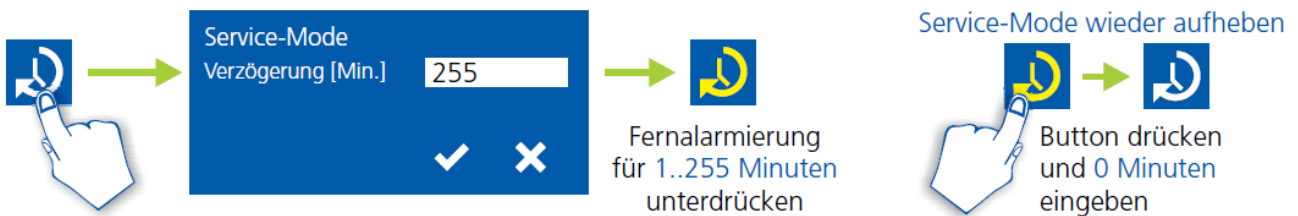

- i** The service mode can only be activated if the system centre has previously been unlocked; see chapter [System centre CI 4x00](#).

8.3.4.2 Store computer CI 3x00 - Service-Mode

Activating/deactivating service mode

Step 1: Select menu item 9 "Parametrisation" in the main menu.

Step 2: Select menu item 3 "Lock-down" in this menu.

Step 3: Tap the buttons **MODE + ENTER** (↵) simultaneously to open the screen for the suppression of the remote alarm signalling and input the service duration (1..255 minutes). The service mode is now activated for the duration entered above.

Step 4: The service mode can be reset / revoked again by the input of 0 minutes.

9 Menu structure UA 400

9.1 Controller type UA 111 - menu tree

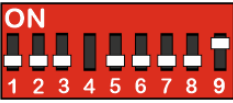
DIP switch S3	UA 111
	1: OFF 2: OFF 3: OFF 4: ON/OFF = Master / Slave mode ON/OFF 5..8: OFF 9: ON

Main menu	Submenu	Submenu 2	Menu number	Menu name
			0	REFRIGERATION POINT
Actual values			1	ACTUAL VALUES
	Temperature sensor		1-1	TEMPERATURE
	Cooling Zone 1		1-2	COOLING 1
	Defrost Zone 1		1-3	DEFROST 1
	–			
	Alarm		1-5	ALARM
	Frame heater		1-6	FRAME HEATER
	Cooling Zone 2		1-7	COOLING 2
	Defrost Zone 2		1-8	DEFROST 2
Setpoints			2	SETPOINTS
	Cooling		2-1	COOLING
		Zone 1	2-1-1	COOLING 1
		Zone 2	2-1-2	COOLING 2
		Zone 1 U Toggle	2-1-3	COOLING 1U
		Zone 2 U Toggle	2-1-4	COOLING 2U
	Defrost		2-2	DEFROST
		Zone 1	2-2-1	DEFROST 1
		Zone 2	2-2-2	DEFROST 2
		Zone 1 U Toggle	2-2-3	DEFROST 1U
		Zone 2 U Toggle	2-2-4	DEFROST 2U
		–		

	Alarm		2-4	ALARM	
		Zone 1	2-4-1	ALARM 1	
		Zone 2	2-4-2	ALARM 2	
		Zone 1 U Toggle	2-4-3	ALARM 1U	
		Zone 2 U Toggle	2-4-4	ALARM 2U	
	Frame heater			2-5	RAHMENHEIZ
		Frame heater mode		2-5-1	FRAME HEATER
		Frame heater setpoints		2-5-2	SETPOINTS
		Toggle mode		2-5-3	RAHMEN UM.
		Toggle setpoints		2-5-4	SOLLW. UM.
Clock			3	CLOCK	
	Current time		3-1	CLOCK	
	Defrost timer		3-2	DEFROST TIMER	
		Abt.Uhr Z2		3-2-a	ABT.UHR Z2
	Toggle setpoints		3-3	UMSCHALTNG	
Messages			4	MESSAGES	
	view		4-1	MESSAGES	
	acknowledge		4-2		
	delete		4-3	MESSAGES	
Archive			5	ARCHIVE	
Configuration			6	KONFIGURAT	
	Refrigeration point		6-1	REFRIGERATION POINT	
	Controller		6-2	CONTROLLER	
		Type and version		6-2-1	VERSION
		Temperature display		6-2-2	DISPLAY
		Alarm delay		6-2-3	ALARMVERZ.
		230 V inputs		6-2-4	230V EING.
		Sensor type		6-2-5	SENSOR TYPE
	Cooling		6-3	COOLING	

Eckelmann

Language		6-4	LANGUAGE
Alarm priorities		6-5	ALARMPRIOS
Emergency power operation		6-6	NOTNETZ
Advanced		6-7	ADVANCED
	SDS TEV	6-7-1	SDS TEV
	Service Mode	6-7-2	SERVICE MOD

9.1.1 Main menu UA 111

REFR. PT. POS: XXXXX	
1 Actual Values	Move to menu 1
2 Setpoints	Move to menu 2
3 Clock	Move to menu 3
4 Messages	Move to menu 4
5 Archive	Move to menu 5
6 Configuration	Move to menu 6

9.1.2 Menu 1 Actual Values UA 111

ACT VALUES POS: XXXXX	
1 Temp. Sensor	Move to menu 1-1
2 Cooling Zone 1	Move to menu 1-2
3 Defrost Zone 1	Move to menu 1-3
4	Not used with this controller type
5 Alarm	Move to menu 1-5
6 Frame Heater	Move to menu 1-6
7 Cooling Zone 2	Move to menu 1-7 Only shown when two-zone operation is set (Menu 6-1)
8 Defrost Zone 2	Move to menu 1-8 Only shown when two-zone operation is set (Menu 6-1)

- Menu 1-1 Temp. Sensor

TEMPERATUR Pos: XXXXX	
Temp. R2.1 xxx °C	Current supply air temperature Input Z11/ Z12
Temp. R4.1 xxx °C	Current return air temperature Input Z21/ Z22
Temp. R2.2 xxx °C	Current supply air temperature Input Z31/ Z32
Temp. R4.2 xxx °C	Current return air temperature Input Z41/ Z42
Temp. R2.3 xxx °C	Current supply air temperature Input Z51/ Z52
Temp. R4.3 xxx °C	Current return air temperature Input Z61/ Z62
Temp. R2.4 xxx °C	Current supply air temperature Input Z71/ Z72
Temp. R4.4 xxx °C	Current return air temperature Input Z81/ Z82

- Menu 1-2 Cooling Zone 1

COOLING 1 Pos: XXXXX	
Cooling xxx	Current ON/OFF status of cooling
Run Time xx %	Cooling relay on time during last day (0000 - 2400 hours)
Starts 0	Cooling relay actuations during last day
Temp. R2.1 xxx °C	Current supply air temperature Input Z11/Z12
Setpoint R2.1 xxx °C	Supply air temperature setpoint for comparison
Hysteresis R2.1 xxx K	Supply air temperature hysteresis setpoint
Temp. R4.1 xxx °C	Current return air temperature Input Z21/Z22
Setpoint R4.1 xxx °C	Return air temperature setpoint for comparison
Hysteresis R4.1 xxx K	Return air temperature hysteresis setpoint

- Menu 1-3 Defrost Zone 1

DEFROST 1 Pos: XXXXX	
Defrost XXX	Current ON/OFF status of defrosting
Temp. R2.1 XXX °C	Current supply air temperature Input Z11/Z12
Temp. R2.2 XXX °C	Current supply air temperature Input Z31/Z32
Def. End. Tmp. XXX °C	Defrost termination temperature for comparison
Last Defrost XX hh:mm	Day and time of last defrost cycle started
M/S Nof. Sl.	Number of parameterised and accessible MA slaves
M/S Lost Sl.	CAN address of the first MA slave which was not accessible during the last defrost
M/S Defr.Sl.	Number of slaves currently undergoing a defrost
M/S DSIMat	List of MA slaves currently undergoing a defrost (can be scrolled through using ENTER)
DSq Nof. Sl.	Number of DS slaves (only in the case of DS master)
DSq Lost Sl.	CAN address of the first FA slave which was not accessible during the last defrost
DSq Defr.Sl.	Number of slaves currently undergoing defrost
DSq DSIMat	List of FA slaves currently undergoing a defrost (can be scrolled through using ENTER)

- Menu 1-4
Not used with this controller type.

- Menu 1-5 Alarm

ALARM Pos: XXXXX	
Alarm Relay XXX	Current ON/OFF status of alarm output Terminal 15/16/18
Hi Temp Setp.1 XX °C	High temperature setpoint Zone 1
Lo Temp Setp.1 XX K	Low temperature setpoint Zone 1
Hi Temp Setp.2 XX °C	High temperature setpoint Zone 2; Only shown when two-zone operation is set (Menu 6-1)
Lo Temp Setp.2 XX K	Low temperature setpoint Zone 2; Only shown when two-zone operation is set (Menu 6-1)

- Menu 1-6 Frame Heater

MODE XXXXX	
Frame Heater xxx	Current ON/OFF status of frame heater output Terminal 91/92/93
Run Time xxx %	Current on time of frame heater
Humidity xxx %	Current ambient air humidity (transmitted via CAN bus from pack controller with fitted ambient humidity sensor)
Room temp xx °C	Current ambient air temperature (transmitted via CAN bus from pack controller with fitted ambient temperature sensor)

- Menu 1-7 Cooling Zone 2

COOLING 2 XXXXX	
Cooling XXX	Current ON/OFF status of cooling
Run Time XX %	Cooling relay on time during last day (00:00 - 24:00 hours)
Starts 0	Cooling relay actuations during last day
Temp. R2.3 XXX °C	Current supply air temperature Input Z51/Z52
Setpoint R2.3 XXX °C	Supply air temperature setpoint for comparison
Hysteresis R2.3 XXX K	Supply air temperature hysteresis setpoint
Temp. R4.3 XXX °C	Current return air temperature Input Z61/Z62
Setpoint R4.3 XXX °C	Return air temperature setpoint for comparison
Hysteresis R4.3 XXX K	Return air temperature hysteresis setpoint

- Menu 1-8 Defrost Zone 2

DEFROST 2 Pos: XXXXX	
Defrost XXX	Current ON/OFF status of defrosting
Temp. R2.3 XXX °C	Current supply air temperature Input Z51/Z52

Eckelmann

DEFROST 2 Pos: XXXXX	
Temp. R2.4 XXX °C	Current supply air temperature Input Z71/Z72
Def. End. Tmp. XXX °C	Defrost termination temperature for comparison
Last Defrost XX hh:mm	Day and time of last defrost cycle started

9.1.3 Menu 2 Setpoints UA 111

SETPOINTS POS: XXXXX	
1 Cooling	Move to menu 2-1 Special case: Move to menu 2-1-1 when single-zone operation is set (Menu 6-1) and setpoint toggle is disabled (Menu 3-3).
2 Defrost	Move to menu 2-2 Special case: Move to menu 2-2-1 when single-zone operation is set (Menu 6-1) and setpoint toggle is disabled (Menu 3-3).
3	Not used with this controller type
4 Alarm	Move to menu 2-4 Special case: Move to menu 2-4-1 when single-zone operation is set (Menu 6-1) and setpoint toggle is disabled (Menu 3-3).
5 Frame Heater	Move to menu 2-5

- Menu 2-1 Cooling

COOLING POS: XXXXX	
1 Zone 1	Menu 2-1-1
2 Zone 2	Menu 2-1-2 Only shown when two-zone operation is set (Menu 6-1)
3 Zone 1A Altern.	Menu 2-1-3 Not shown when setpoint toggle is disabled (Menu 3-3)
4 Zone 2A Altern.	Menu 2-1-4 Only shown when two-zone operation is set (Menu 6-1) and setpoint toggle is not disabled (Menu 3-3)

- Menu 2-1-1 Zone 1

COOLING 1 POS: XXXXX		Entry	Default
Setpoint R2.1 XXX °C	Supply air temperature setpoint	-10..20	-2 °C
Hystersis R2.1 X K	Supply air temperature hysteresis setpoint	1..8	4 K
Setpoint R4.1 XXX °C	Return air temperature setpoint for comparison	-10..25	5 °C
Hystersis R4.1 X K	Return air temperature hysteresis setpoint	1..8	2 K

- Menu 2-1-2 Zone 2

COOLING 2 POS: XXXXX		Entry	Default
Setpoint R2.3 XXX °C	Supply air temperature setpoint	-10..20	-2 °C
Hystersis R2.3 X K	Supply air temperature hysteresis setpoint	1..8	4 K
Setpoint R4.3 XXX °C	Return air temperature setpoint for comparison	-10..25	5 °C
Hystersis R4.3 X K	Return air temperature hysteresis setpoint	1..8	2 K

- Menu 2-1-3 Zone 1A Altern.

COOLING 1A POS: XXXXX		Entry	Default
Setpoint R2.1 XXX °C	Supply air temperature setpoint	-10..20	0 °C
Hystersis R2.1 X K	Supply air temperature hysteresis setpoint	1..8	4 K
Setpoint R4.1 XXX °C	Return air temperature setpoint for comparison	-10..25	4 °C
Hystersis R4.1 X K	Return air temperature hysteresis setpoint	1..8	2 K

- Menu 2-1-4 Zone 2A Altern.

COOLING 2A POS: XXXXX		Entry	Default
Setpoint R2.3 XXX °C	Supply air temperature setpoint	-10..20	0 °C
Hystersis R2.3 X K	Supply air temperature hysteresis setpoint	1..8	4 K
Setpoint R4.3 XXX °C	Return air temperature setpoint for comparison	-10..25	5 °C
Hystersis R4.3 X K	Return air temperature hysteresis setpoint	1..8	2 K

- Menu 2-2 Defrost

DEFROST POS: XXXXX	
1 Zone 1	Menu 2-2-1
2 Zone 2	Menu 2-2-2 Only shown when two-zone operation is set (Menu 6-1)
3 Zone 1A Altern.	Menu 2-2-3 Not shown when setpoint toggle is disabled (Menu 3-3)
4 Zone 2A Altern.	Menu 2-2-4 Only shown when two-zone operation is set (Menu 6-1) and setpoint toggle is not disabled (Menu 3-3)

- Menu 2-2-1 Zone 1

DEFROST 1 POS: XXXXX		Entry	Default
Def. End. Tmp. XX °C	Defrost termination temperature setpoint	--, 5..20	8 °C
M/S Degiv.Fct. XXX	Configuration of the defrost via CAN bus function. For details see chapter Master-Slave-Modus - Abtau-Synchronisation über CAN-Bus.	OFF, MASTR, SLAVE	OFF
M/S CAN Adr. XXX	Selection of the controller (1..99) participating in the defrost via CAN bus which is the master. "-", if this controller is itself master (Parameter <i>M/S Degiv.Fct.</i> = MASTR)	---, 1..99	–
DS-Function XXX	Configuration of the defrost sequence function (DS).For details see chapter Folgeabtauung (FA) über CAN-Bus.	OFF, MASTR, SLAVE	OFF
DS-Group XXX	Selection of which group a defrost sequence of this controller (1..99) belongs to.	---, 1..99	–
DS-Master XXX	Selection of which controller (1..99) participating in the defrost sequence is the master. "-", if this controller is itself the master(Parameter <i>DS-Function</i> = MASTR)	---, 1..99	–
DS-Wait time XXXm	Wait time for the defrost sequence	0..127	1 min

- Menu 2-2-2 Zone 2

Eckelmann

DEFROST 2 POS: XXXXX		Entry	Default
Def. End. Tmp. XX °C	Defrost termination temperature setpoint	--, 5..20	8 °C

- Menu 2-2-3 Zone 1A Altern.

DEFROST 1A POS: XXXXX		Entry	Default
Def. End. Tmp. XX °C	Defrost termination temperature setpoint	--, 5..20	5 °C

- Menu 2-2-4 Zone 2A Altern.

DEFROST 2A POS: XXXXX		Entry	Default
Def. End. Temp. XX °C	Defrost termination temperature setpoint	--, 5..20	5 °C

- Menu 2-3
Not used with this controller type.
- Menu 2-4 Alarm

ALARM POS: XXXXX	
1 Zone 1	Menu 2-4-1
2 Zone 2	Menu 2-4-2 Only shown when two-zone operation is set (Menu 6-1)
3 Zone 1A Altern.	Menu 2-4-3 Not shown when setpoint toggle is disabled (Menu 3-3)
4 Zone 2A Altern.	Menu 2-4-4 Only shown when two-zone operation is set (Menu 6-1) and setpoint toggle is not disabled (Menu 3-3)

- Menu 2-4-1 Zone 1

ALARM 1 POS: XXXXX		Entry	Default
High Temp Setp XX °C	High temperature setpoint at which <i>High Temperature</i> alarm is generated	0..30	8 °C
Low Temp Setp. XX K	Low temperature setpoint (difference below temperature control setpoint) at which <i>Low Temperature</i> alarm is generated	--, 0..6	4 K

- Menu 2-4-2 Zone 2

ALARM 2 POS: XXXXX		Entry	Default
High Temp Setp XX °C	High temperature setpoint at which <i>High Temperature</i> alarm is generated	0..30	8 °C
Low Temp Setp. XX K	Low temperature setpoint (difference below temperature control setpoint) at which <i>Low Temperature</i> alarm is generated	--, 0..6	4 K

- Menu 2-4-3 Zone 1A Altern.

ALARM 1A POS: XXXXX		Entry	Default
High Temp Setp XX °C	High temperature setpoint at which <i>High Temperature</i> alarm is generated	0..30	8 °C
Low Temp Setp. XX K	Low temperature setpoint (difference below temperature control setpoint) at which <i>Low Temperature</i> alarm is generated	--, 0..6	4 K

- Menu 2-4-4 Zone 2A Altern.

Eckelmann

ALARM 2A POS: XXXXX		Entry	Default
High Temp Setp. XX °C	High temperature setpoint at which <i>High Temperature</i> alarm is generated	0..30	8 °C
Low Temp Setp. XX K	Low temperature setpoint (difference below temperature control setpoint) at which <i>Low Temperature</i> alarm is generated	--, 0..6	4 K

- Menu 2-5 Frame Heater

FRAME HTR POS: XXXXX	
1 Mode altern.	Move to menu 2-5-1
2 Setpoint frm htr	Move to menu 2-5-2
3 Mode altern.	Move to menu 2-5-3 Not shown when setpoint toggle is disabled (Menu 3-3)
4 Setpoint altern.	Move to menu 2-5-4 Not shown when setpoint toggle is disabled (Menu 3-3)

- Menu 2-5-1 Mode altern.

Select between values. Checkmark shows current setting.

MODE POS: XXXXX		Entry	Default
fixed run time <input checked="" type="checkbox"/>	Fixed frame heater on time	↵	<input checked="" type="checkbox"/>
enthalpy-ctrl rtm	Enthalpy control by ambient air temperature and humidity	↵	<input type="checkbox"/>

- Menu 2-5-2 Setpoint frame heater

SETPOINTS POS: XXXXX		Entry	Default
Mod: xxxxxxxxxxxx	Displays set frame heater mode (Menu 2-5-1)		Fixed on time
Run Time XXX %	Fixed on time, Only shown when mode set to Fixed On Time (Menu 2-5-1)	--, 0..100	100 %
emerg.run time XXX %	On time in failure of ambient air humidity or temperature signal (via CAN bus) Only shown when mode set to Enthalpy Control (Menu 2-5-1)	--, 0..100	100 %
enthalp. offs. XXX %	Offset to on time with activated enthalpy control (via CAN bus) Only shown when mode set to Enthalpy Control (Menu 2-5-1)	-50..50	0 %
Invert Output xxx	Inversion of the function of the frame heater output (terminal 91/92)	↑, ↓, (ON/OFF)	ON

Eckelmann

- Menu 2-5-3 Mode altern.

Select between values. Checkmark shows current setting.

MODE ALT POS: XXXXX		Entry	Default
fixed run time ✓	Fixed frame heater on time	↵	✓
enthalpy-ctrl rtm	Enthalpy control by ambient air temperature and humidity	↵	

- Menu 2-5-4 Setpoint altern.

SOLLW. UM POS: XXXXX		Entry	Default
Mod: xxxxxxxxxxxx	Displays set frame heater mode (Menu 2-5-3)		Fixed on time
Run Time XXX %	Fixed on time, Only shown when mode set to Fixed On Time (Menu 2-5-3)	--, 0..100	100 %
emerg.run time XXX %	On time in failure of ambient air humidity or temperature signal (via CAN bus) Only shown when mode set to Enthalpy Control (Menu 2-5-3)	--, 0..100	100 %
enthalp. offs. XXX %	Offset to on time with activated enthalpy control (via CAN bus) Only shown when mode set to Enthalpy Control (Menu 2-5-3)	-50..50	0 %

9.1.4 Menu 3 Clock UA 111

CLOCK POS: XXXXX		Entry
1 Current Time	Move to menu 3-1	1
2 Defrost timer	Move to menu 3-2	2
3 Toggle Setpoints	Move to menu 3-3	3

- Menu 3-1 Current Time

 Time is defined by time master (system centre / store computer / operator terminal) when CAN bus is connected. Any entry made will then be overwritten by the defined value.

CLOCK POS: XXXXX		Entry	Default
Date: XX dd.mm.yy	Display and enter current weekday, date	dd.mm.yy	
Time: hh.mm	Display and enter current time	hh.mm	
Daylight Saving X	Display and enter automatic daylight saving change (Y/N)	↑, ↓, (Y/N)	J

- Menu 3-2 Defrost timer

DERF. TIMER POS: XXXXX		Entry	Default
Defrost timer XXX	Defrost initiation via input D11/12 (EXT) or internal (INT)	↑, ↓, (EXT, INT)	INT
Safe Defr Time XXX m	Safe defrost time for maximum allowed duration of defrosting (used only for internal defrosting)	0..120	60 min
Manual Defrost XXX	Status (OFF/ON) for supplementary manual defrosting *) shown only when parameter defrost timer = INT	↑, ↓, (ON/OFF)	OFF
Def.Tim.Z2	Separate defrost timer for zone 2	Menu 3-2-a	
Defr. 1 xxxxx hh:mm	Defrost start time with internal defrosting; Weekday, time; shown only when parameter defrost timer = INT	↑, ↓, (Mo-Su etc.) or numbers (hh:mm)	Mo-Su01:00
Defr. 2 xxxxx hh:mm	Defrost start time with internal defrosting; Weekday, time; shown only when parameter defrost timer = INT	↑, ↓, (Mo-Su etc.) or numbers (hh:mm)	Mo-Su07:00
Defr. 3 xxxxx hh:mm	Defrost start time with internal defrosting; Weekday, time; shown only when parameter defrost timer = INT	↑, ↓, (Mo-Su etc.) or numbers (hh:mm)	Mo-Su13:00

DERF. TIMER POS: XXXXX		Entry	Default
Defr. 4 xxxxx hh:mm	Defrost start time with internal defrosting; Weekday, time; shown only when parameter defrost timer = INT	↑ ↓ , , (Mo-Su etc.) or numbers (hh:mm)	Mo-Su20:00
...			
Defr. 14 xxxxx hh:mm			

 *) Parameter automatically set to ON for safe defrost time at first start.

- Menu 3-2-a Def.Tim.Z2

DEFR.TIMER POS: XXXXX		Entry	Default
Defrost Timer XXX	Setting for how temperature zone 2 should defrost:- MitZ1 Together with zone 1- INT Internally- EXT Externally – the defrost of both temperature zones is started simultaneously via the external signal	↑ ↓ , , (ViaZ1 (ViaZ1,EXT,INT)	ViaZ1
Safe Defr Time XXX m	Safe defrost time, i.e. max. allowed duration of defrosting (internal defrost only)	0..120	60 min
Manual Defrost XXX	Status (ON/OFF) of auxiliary manual defrost *)	↑ ↓ , , (ON/OFF)	OFF
Defr. 1 xxxxx hh:mm	Defrost start time for internal defrost; weekday, time of day; shown only when parameter <i>defrost timer</i> = INT	↑ ↓ , , (Mo-Su) or numbers (hh:mm)	Mo-Su01:00
...			
Defr. 14 xxxxx hh:mm			

Eckelmann

• Menu 3-3 Toggle Setpoints

TOGGLE POS: XXXXX		Entry	Default
Status XXX	Setpoint toggle status (OFF/ON) of alternative set of setpoints (setpoint toggle)		
Toggle Setp. XXX	Setpoint toggle via <ul style="list-style-type: none"> EXT digital input D21/22 INT internal timer CAN bus- „-“ deactivated 	↑ ↓ , (EXT, INT, CAN, -)	EXT
Blind On Time X s	Fan and cooling stop time after toggling to alternative set of setpoints with external setpoint toggle (Menu 3-3)	0..250	50 sec
Alt ON: DD-DD hh:mm	Start time for toggle to alternative set of setpoints Weekday from - to XXXXX, time hh:mm Only shown when internal setpoint toggle is activated (Menu 3-3)	↑ ↓ , (Mo-Su etc.) or numbers (hh:mm)	Mo-Su 21:00
Alt OFF: DD-DD hh:mm	End time for toggle to alternative set of setpoints Weekday from - to XXXXX, time hh:mm Only shown when internal setpoint toggle is activated (Menu 3-3)	↑ ↓ , (Mo-Su etc.) or numbers (hh:mm)	Mo-Su 05:00
Alt ON: DD-DD hh:mm	Start time for toggle to alternative set of setpoints Weekday from - to XXXXX, time hh:mm Only shown when internal setpoint toggle is activated (Menu 3-3)	↑ ↓ , (Mo-Su etc.) or numbers (hh:mm)	Su 05:00
Alt OFF: DD-DD hh:mm	End time for toggle to alternative set of setpoints Weekday from - to XXXXX, time hh:mm Only shown when internal setpoint toggle is activated (Menu 3-3)	↑ ↓ , (Mo-Su etc.) or numbers (hh:mm)	Su 21:00
...	A total of 7 different ON and OFF toggle times can be defined. A toggle time will only be obeyed when a <u>matched pair</u> of on and off times is set as a parameter.		

9.1.5 Menu 4 Messages UA 111

MESSAGES POS: XXXXX	
1 View	Move to menu 4-1: Show Message Log
2 Acknowledge	Messages in message log are cancelled. <i>"Alarms Cancelled!"</i> shown in display: Press ESC to go back.
3 Delete	Move to menu 4-2: Delete Message Log (with prompt)

- Menu 4-1 View Messages

MESSAGES POS: XXXXX	
Error Message 1:	Fault 1 message text
dd.mm.yy hh:mm ON	Start of Fault 1
dd.mm.yy hh:mm OFF	End of Fault 1 (only when Fault 1 terminated)
...	
Error Message n:	Fault n message text
dd.mm.yy hh:mm ON	Start of Fault n
dd.mm.yy hh:mm OFF	End of Fault n (only when Fault n terminated)

- Menu 4-2 Acknowledge Messages
This displays the *"Alarms Cancelled!"* message.
- Menu 4-3 Delete Messages

MESSAGES POS: XXXXX		Entry
Delete! Are you sure? No: ESC YES: ↵	Safety prompt for deleting messages Press ESC to go back after cancelling messages.	↵, ESC

9.1.6 Menu 5 Archive UA 111

ARCHIVE POS: XXXXX	
dd.mm.yy hh:mm	Time of archiving Record 1
Zone 1: abcdef x °C	Status and temperature of Zone 1, see Note
Zone 2: abcdef x °C	Status and temperature of Zone 2, see Note Only shown when two-zone operation is set (Menu 6-1)
...	
dd.mm.yy hh:mm	Time of archiving Record n
Zone 1: abcdef x °C	Status and temperature of Zone 1, see Note
Zone 2: abcdef x °C	Status and temperature of Zone 2, see Note Only shown when two-zone operation is set (Menu 6-1)

 *) Status abcdef covers following states of refrigeration point. The entry at this position is - when a state is not active. Example Zone 1: abcdef x °C

	Single-zone operation resp. Operator interface BT 300	Two-zone operation
a	O = Operation	O = Operation
b	R = Refrigeration / Cooling	R = Refrigeration / Cooling
c	R = Refrigeration/ Cooling	D = Defrost
d	D = Defrost	G = Gate / Door (cold-room controller only)
e	G = Gate / Door (cold-room controller only)	A = Alarm
f	A = Alarm	

9.1.7 Menu 6 Configuration UA 111

KONFIGURAT POS: XXXXX	
1 Refrigeration point	Continue to menu 6-1
2 Controller	Continue to menu 6-2
3 Cooling	Continue to menu 6-3
4 Language	Continue to menu 6-4
5 Alarm Priorities	Continue to menu 6-5
6 Emergency power operation	Continue to menu 6-6
7 Advanced	Continue to menu 6-7

- Menu 6-1 - Refrigeration point

KÜHLSTELLE POS: XXXXX		Input	Default
Refr. Pt. Name:	Only text		
xxxxxxxxxxxxxxxx	Free text that designated the refrigeration point (see note after the table)		Case controller
Position: XXXXX	Free text that is displayed in the menu after position (POS) (see note after the table)		UA400
Priority: XX	Priority of the alarms for refrigeration point failure or setting of the global controller priority (menu 6-5)	↑, ↓, or numbers (0..99)	1
Verbund Nr.: XX	Number of the pack controller that the case controller is assigned to	↑, ↓, or numbers (--, 1..9)	1
Verbundsatz: XXX	Membership of a compressor pack; This parameter is only required for coupling to a VS 3010 BS with multiple zones. This parameter must be disabled (--) if any other type of pack controller is used.	↑, ↓, or numbers (---, Z1, Z2)	—
Temperaturzonen X	Number of temperature zones Single-zone operation Two-zone operation	↑, ↓, or numbers (1, 2)	2
Fühleranzahl XX	Display of the connected temperature sensors After input of ↵, a sensor scan is performed, during which the number of sensors is determined again.	↵	

 The priority for older versions of the store computer (< V5.0) may only be allocated in the range 0..2; see [chapter 10.1 Alarm signalling and monitoring](#) Alarm signalling / individual allocation of the priorities.

- ① A meaningful name should be entered which provides details about the position of the sensor, e.g. Cheese Counter 2 and KT2. The input is made using the menus of the system centre / store computer / operator terminal. Direct input using the menus of the case controller shown in the operator terminal is not possible. It is also not possible to make the entry using the BT 300 operator interface.

- Menu 6-2 - Controller

REGLER POS: XXXXX	
1 Type and version	Continue to menu 6-2-1
2 Temperature display	Continue to menu 6-2-2
3 Alarm delay	Continue to menu 6-2-3
4 230 V inputs	Continue to menu 6-2-4
5 Sensor type	Continue to menu 6-2-5

- Menu 6-2-1 Type and version

VERSION POS: XXXXX		Input	Default
ReglertypXXXXXXXX	Controller type that is set using the DIP switch S3	–	UA111
Software Vers.:XXXX	Software version of the case controller	–	x.yy
Gerät Nr.:XXXXXX	Serial number of the case controller	–	
Master/Sl. ModeXXX	Synchronised defrost in the master / slave mode (ON/OFF)	–	

- Menu 6-2-2 Temperature display

ANZEIGE POS: XXXXX		Input	Default
OffsetXX K	Offset for the display of the temperature	-10..10	0K
AlarmsymbolX	Display of the alarm symbol in the temperature display of the BT30	↑, ↓, (Y, N)	N

- Menu 6-2-3 Alarm delay

ALARMVERZ. ID: XXXXX		Input	Default
FühlerbruchXX m	Alarm delay for sensor fault	0..30	15 min
Über/Unter TmpXX m	Alarm delay for overtemperature / low temperature	0..120	60 min
keine AbtauungXX h	Alarm delay for no defrost	--, 2..168	24 h
SelbsthaltungX	NO: Automatic reset of non-transient alarms. YES: Alarms must be reset manually.	↑, ↓, (Y/N)	N

- Menu 6-2-4 230 V inputs

⚠ The changeover of the inputs is only intended for trained personnel as changes can also affect the further functionality of the controller.

230 V INPUTS ID: XXXXX		Input	Default
Input 1: XXXXXXXXXXXX	Function of the digital input 1 D11/D12	1)	DEFROST TIMER
Input 2: XXXXXXXXXXXX	Function of the digital input 2 D21/D22	2)	SOLLW.UMSCH
Input 3: XXXXXXXXXXXX	Function of the digital input 3 D31/D32	3)	MANUAL OFF
Input 4: XXXXXXXXXXXX	Function of the digital input 4 D41/D42	4)	EXTERNAL ALARM
XXXXXXXXXXXXXXXXXXXX	Freely configurable alarm text for digital input 4, the default text is "CO2-Alarm"	Text	CO2-Alarm
Inv. D1 XXX	Inversion of digital input 1	↑, ↓, (ON/OFF)	OFF
Inv. D2 XXX	Inversion of digital input 2		OFF
Inv. D3 XXX	Inversion of digital input 3		OFF
Inv. D4 XXX	Inversion of digital input 4		OFF

Possible settings for the digital inputs:

1. ABTAUUHR defrost timer *
 HANDABSCH. Manual shutdown of both zones
 HANDABSCH. Z1Handabschaltung only Z1
 HANDABSCH. Z2Handabschaltung only Z2
 SOLLW.UMSCH.Toggle setpoint
2. SOLLW.UMSCH Toggle setpoint *
 HANDABSCH. Manual shutdown of both zones
 HANDABSCH. Z1Handabschaltung only Z1
 HANDABSCH. Z2Handabschaltung only Z2
3. HANDABSCH. Manual shutdown of both zones *
 HANDABSCH. Z1Handabschaltung only Z1
 HANDABSCH. Z2Handabschaltung only Z2
4. FREMDALARM External alarm *
 HANDABSCH.Manual shutdown of both zones
 HANDABSCH. Z1Handabschaltung only Z1
 HANDABSCH. Z2Handabschaltung only Z2
 SOLLW.UMSCH.Toggle setpoint

*Factory setting

- Menu 6-2-5 Sensor type

Eckelmann

The value is selected in accordance with the entry. The check mark indicates the current setting.

FÜHLERTYP POS: XXXXX		Input	Default
L243 ✓	Temperature range -50..50 °C	↵	✓
K277	Temperature range -50..50 °C	↵	
5K3A1	Temperature range 0..100°C	↵	

- Menu 6-3 Cooling

KÜHLUNG POS: XXXXX		Input	Default
min. Laufzeit XX K	Minimum run time of the cooling	0..15	2 m
min. Standzeit XX m	Minimum switch-off time of the cooling	0..15	2 m
Dauerl.überw. XX m	Time for the forced interruption of the cooling during continuous operation	--, 0..15	0 m
Notbetrieb XX m	If necessary sensors for the regulation fail, the solenoid valve is actuated with the opening degree in [%]set here.	0..100	40%

- Menu 6-4 - Language

SPRACHE POS: XXXXX	Input	Default
Deutsch D ✓	↵	✓
English GB	↵	
Français F	↵	
Espagnol E	↵	
Finnish FIN	↵	
Türkce TR	↵	
Cesky CZ	↵	

- Menu 6-5 Alarm priorities

ALARMPRIOS POS: XXXXX		Input	Default
KühlstellenprioX	Priority of the alarms can be set globally using the refrigeration point priority (menu 6-1) (Y)	↑, ↓, (Y,N)	N
Priorität:XX	Display of refrigeration point priority (menu 6-1) only displayed if Kühlstellenprio is set to Y		
<p><i>The following parameters are only displayed if Kühlstellenprio is set to N. The possible entries for the priority of the alarms have the following meanings: -=Event is ignored 0=Message (only entry in message list) 1=Alarm with priority 1 .. 99=Alarm with priority 99</i></p>			
Low temp.	Lower alarm temperature limit value undercut; priority is applicable for all messages <i>low-temp. zone 1, low-temp. zone 2</i>	-, 0..99	2
High temp	Upper alarm temperature limit value exceeded; priority is applicable for all messages <i>high-temp. zone 1, high-temp. zone 2</i>	-, 0..99	1
Sensor fault	Temperature sensor failed	-, 0..99	2
No Defrost	No defrost within the alarm delay time Priority is applicable for the message <i>No Defrost</i>	-, 0..99	2
Timer-Term. Defrost	Defrost ended by safe defrost time	-, 0..99	0
Power failure	Start-up after power failure	-, 0..99	0
First start	Commissioning of the controller (basic settings loaded!)	-, 0..99	2

ALARMPRIOS POS: XXXXX		Input	Default
Manual shutdown	Manual control switch input D31/ D32 on OFF	-, 0..99	0
Hardware fault	The internal hardware has a fault Priority is applicable for the messages <i>EEPROM fault, RTC fault, Flash fault</i>	-, 0..99	1
Sollwertverst.	Message is generated during setpoint adjustment	0..99	0
Refrig.Pt.Dis.	Cooling interrupted by VS via CAN bus	-, 0..99	0
Batteriespannung	Low battery voltage	-, 0..99	0

- Menu 6-6 - Emergency power operation

NOTNETZ POS: XXXXX		Input	Default
Fkt. Kühl. AUS xxx	Cooling functionality switched off during emergency power operation? (Y/N)	↑ , ↓ , (Y/N)	N
Fkt. Abt. AUS xxx	Defrost functionality switched off during emergency power operation? (Y/N)	↑ , ↓ , (Y/N)	N
Fkt. Lüft. AUS xxx	Fans functionality switched off during emergency power operation? (Y/N)	↑ , ↓ , (Y/N)	N
Fkt. Rhmhg.AUS xxx	Frame heater functionality switched off during emergency power operation? (Y/N)	↑ , ↓ , (Y/N)	N
Fkt. Licht AUS xxx	Light functionality switched off during the emergency power operation? (Y/N)	↑ , ↓ , (Y/N)	N

- Menu 6-7 Advanced

Erweitert POS: XXXXX	
1 SDS TEV	Continue to menu 6-7-1
2 Service Mode	Continue to menu 6-7-2

- Menu 6-7-1 SDS TEV

SDS TEV POS: XXXXX		Input	Default
SDS TEV xx m	Basic participation of the controller in the suction pressure shift. Note: This is transmitted via a CAN bus telegram and intervenes in the regulation!	↑ , ↓ , (ON/OFF)	OFF
Inakt.n.Abt xx m	Delay time after completion of the defrost before the controller actively intervenes in the suction pressure shift again.	0..40	30 min
Vrz_HystEIN xx m	Delay time for the reduction request with active cooling and overshoot of the hysteresis.	0..10	2.5 min
ÜTempZ1 ab. xx m	Delay time before expiry of the high temperature zone 1 alarm delay before the reduction is requested	0..15	5 min
ÜTempZ2 ab. xx m	Delay time before expiry of the high temperature zone 2 alarm delay before the reduction is requested	0..15	5 min
TolÜbHystZ1 x K	Tolerance limit above setpoint plus hysteresis in zone 1. Influences when to switch from Hold to Lower.	0..20	2 K
TolÜbHystZ2 x K	Tolerance limit above setpoint plus hysteresis in zone 2. Influences when to switch from Hold to Lower.	0..20	2 K
Umsch_Zu_Rü xxx	Switching from supply air to return air and vice versa during temperature alarm delay time	↑ , ↓ , (ON/OFF)	OFF
Verz Umsch xx m	Switchover of supply/return air: specifies when the switchover takes place within the high temperature alarm delay time	0..15	5 min
Add.Istwrte xxx	Creation of additional debug archives in the system centre / store computer. Attention: can force a reorganisation of the actual value archives in the system centre / store computer! Only use when required!	↑ , ↓ , (ON/OFF)	OFF
Steig_OberG xxx K	Upper limit of the neutral zone for gradient determination.	0..5	0.3 K
Steig_UntrG xxx K	Lower limit of the neutral zone for gradient determination.	0..5	0.2 K

- Menu 6-7-2 Service Mode

Service Mod POS: XXXXX		Input	Default
Relais 1x	Relay 1 (terminals 15/16/18) switch on or switch off (1 or 0)	0 / 1	0
Relais 2x	Relay 2 (terminals 25/26/28) switch on or switch off (1 or 0)	0 / 1	0
Relais 3x	Relay 3 (terminals 35/36/38) switch on or switch off (1 or 0)	0 / 1	0
Relais 4x	Relay 4 (terminals 43/44) switch on or switch off (1 or 0)	0 / 1	0
Relais 5x	Relay 5 (terminals 53/54) switch on or switch off (1 or 0)	0 / 1	0
Relais 6x	Relay 6 (terminals 64/65) switch on or switch off (1 or 0)	0 / 1	0
Relais 7x	Relay 7 (terminals 73/74) switch on or switch off (1 or 0)	0 / 1	0
24V Out 1x	Transistor output 1 (terminals 81/82) switch on or switch off (24 V DC / 50 mA)	0 / 1	0
24V Out 2x	Transistor output 2 (terminals 91/92) switch on or switch off (24 V DC / 50 mA)	0 / 1	0
ANA OUT 1xxxV	Analogue output 1 (terminals 29/30) default value 0..10 V DC	0..10	0.0V
ANA OUT 2xxxV	Analogue output 2 (terminals 31/32) default value 0..10 V DC	0..10	0.0V
ANA IN 1xxmA	Current at analogue input 1 (terminals 11/12) 4..20 mA	4..20	mA
ANA IN 2xxmA	Current at analogue input 2 (terminals 11/14) 4..20 mA	4..20	mA
InputD 1xxx	Status digital input 1 ON = Voltage 230 V AC applied OFF = No voltage	ON/OFF	-
InputD 2xxx	Status digital input 2 ON = Voltage 230 V AC applied OFF = No voltage	ON/OFF	-
InputD 3xxx	Status digital input 3 ON = Voltage 230 V AC applied OFF = No voltage	ON/OFF	-
InputD 4xxx	Status digital input 4 ON = Voltage 230 V AC applied OFF = No voltage	ON/OFF	-

9.2 Controller type UA 111 D - menu tree

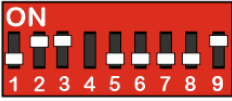
DIP switch S3	UA 111 D
	1: OFF 2: ON 3: ON 4: ON/OFF = Master / Slave mode ON/OFF 5..8: OFF 9: ON

Main menu	Submenu	Submenu 2	Menu number	Menu name
			0	REFRIGERATION POINT
Actual values			1	ACTUAL VALUES
	Temperature sensor		1-1	TEMPERATURE
	Cooling Zone 1		1-2	COOLING 1
	Defrost Zone 1		1-3	DEFROST 1
	–			
	Alarm		1-5	ALARM
	Frame heater		1-6	FRAME HEATER
Setpoints			2	SETPOINTS
	Cooling		2-1	COOLING
	Zone 1		2-1-1	COOLING 1
	–			
	Zone 1 U Toggle		2-1-3	COOLING 1U
	Defrost		2-2	DEFROST
	Zone 1		2-2-1	DEFROST 1
	–			
	Zone 1 U Toggle		2-2-3	DEFROST 1U
	–			
	Alarm		2-4	ALARM
	Zone 1		2-4-1	ALARM 1
	–			
	Zone 1 U Toggle		2-4-3	ALARM 1U

	Frame heater		2-5	RAHMENHEIZ
		Frame heater mode	2-5-1	FRAME HEATER
		Frame heater setpoints	2-5-2	SETPOINTS
		Toggle mode	2-5-3	RAHMEN UM.
		Toggle setpoints	2-5-4	SOLLW. UM.
Clock			3	CLOCK
	current time		3-1	CLOCK
	Defrost timer		3-2	DEFROST TIMER
		Abt.Uhr Z2	3-2-a	ABT.UHR Z2
	Toggle setpoints		3-3	UMSCHALTNG
Messages			4	MESSAGES
	view		4-1	MESSAGES
	acknowledge		4-2	
	delete		4-3	MESSAGES
Archive			5	ARCHIVE
Configuration			6	KONFIGURAT
	Refrigeration point		6-1	REFRIGERATION POINT
	Controller		6-2	CONTROLLER
		Type and version	6-2-1	VERSION
		Temperature display	6-2-2	DISPLAY
		Alarm delay	6-2-3	ALARMVERZ.
		230 V inputs	6-2-4	230 V INPUTS
		Sensor type	6-2-5	SENSOR TYPE
	Cooling		6-3	COOLING
	Language		6-4	LANGUAGE
	Alarm priorities		6-5	ALARMPRIOS
	Emergency power operation		6-6	NOTNETZ
	Advanced		6-7	ADVANCED
		SDS TEV	6-7-1	SDS TEV

Eckelmann

		Service Mode	6-7-2	SERVICE MOD
--	--	--------------	-------	-------------

9.2.1 Main menu UA 111 D

REFR. PT. POS: XXXXX	
1 Actual Values	Move to menu 1
2 Setpoints	Move to menu 2
3 Clock	Move to menu 3
4 Messages	Move to menu 4
5 Archive	Move to menu 5
6 Configuration	Move to menu 6

9.2.2 Menu 1 Actual Values UA 111 D

ACT VALUES POS: XXXXX	
1 Temp. Sensor	Move to menu 1-1
2 Cooling Zone 1	Move to menu 1-2
3 Defrost Zone 1	Move to menu 1-3
4	Not used with this controller type
5 Alarm	Move to menu 1-5
6 Frame Heater	Move to menu 1-6

- Menu 1-1 Temp. Sensor

TEMPERATUR Pos: XXXXX	
Temp. R2.1 xxx °C	Current supply air temperature Input Z11/ Z12
Temp. R4.1 xxx °C	Current return air temperature Input Z21/ Z22
Temp. R2.2 xxx °C	Current supply air temperature Input Z31/ Z32
Temp. R4.2 xxx °C	Current return air temperature Input Z41/ Z42
Temp. R2.3 xxx °C	Current supply air temperature Input Z51/ Z52
Temp. R4.3 xxx °C	Current return air temperature Input Z61/ Z62
Temp. R2.4 xxx °C	Current supply air temperature Input Z71/ Z72
Temp. R4.4 xxx °C	Current return air temperature Input Z81/ Z82
Temp. R2.5 xxx °C	Current supply air temperature Input Z91/ Z92
Temp. R4.5 xxx °C	Current supply air temperature Input Z01/ Z02

- Menu 1-2 Cooling Zone 1

COOLING 1 Pos: XXXXX	
Compressor 1 xxx	Current ON/OFF status Compressor 1
Comp Run Tm 1 xx %	Compressor 1 on time during last days (00:00 - 24:00 hours)
Comp. Starts 1 0	Compressor 1 actuations during last days
Compressor 2 xxx	Current ON/OFF status Compressor 2
Comp Run Tm 2 xx %	Compressor 2 on time during last days (00:00 - 24:00 hours)
Comp. Starts 2 0	Compressor 2 actuations during last days

- Menu 1-3 Defrost Zone 1

DEFROST 1 Pos: XXXXX	
Defrost XXX	Current ON/OFF status of defrosting
Temp. R2.1 XXX °C	Current supply air temperature Input Z11/Z12
Temp. R2.2 XXX °C	Current supply air temperature Input Z31/Z32
Temp. R2.3 XXX °C	Current supply air temperature Input Z51/Z52
Temp. R2.4 XXX °C	Current supply air temperature Input Z71/Z72
Temp. R2.5 XXX °C	Current supply air temperature Input Z91/Z92
Def. End. Tmp. XXX °C	Defrost termination temperature for comparison
Last Defrost XX hh:mm	Day and time of last defrost cycle started
M/S Nof. Sl.	Number of parameterised and accessible MA slaves
M/S Lost Sl.	CAN address of the first MA slave which was not accessible during the last defrost
M/S Defr.Sl.	Number of slaves currently undergoing a defrost
M/S DSIMat	List of MA slaves currently undergoing a defrost (can be scrolled through using ENTER)
DSq Nof. Sl.	Number of DS slaves (only in the case of DS master)
DSq Lost Sl.	CAN address of the first FA slave which was not accessible during the last defrost
DSq Defr.Sl.	Number of slaves currently undergoing defrost
DSq DSIMat	List of FA slaves currently undergoing a defrost (can be scrolled through using ENTER)

- Menu 1-4
Not used with this controller type.
- Menu 1-5 Alarm

ALARM Pos: XXXXX	
Alarm Relay XXX	Current ON/OFF status of alarm output Terminal 15/16/18
Hi Temp Setp.1 XX °C	High temperature setpoint Zone 1
Lo Temp Setp.1 XX K	Low temperature setpoint Zone 1

- Menu 1-6 Frame Heater

MODE XXXXX	
Frame Heater xxx	Current ON/OFF status of frame heater output Terminal 91/92/93
Run Time xxx %	Current on time of frame heater

Eckelmann

MODE XXXXX	
Humidity xxx %	Current ambient air humidity (transmitted via CAN bus from pack controller with fitted ambient humidity sensor)
Room temp xx °C	Current ambient air temperature (transmitted via CAN bus from pack controller with fitted ambient temperature sensor)

9.2.3 Menu 2 Setpoints UA 111 D

SETPOINTS POS: XXXXX	
1 Cooling	Move to menu 2-1 Special case: Move to menu 2-1-1 when single-zone operation is set (Menu 6-1) and setpoint toggle is disabled (Menu 3-3).
2 Defrost	Move to menu 2-2 Special case: Move to menu 2-2-1 when single-zone operation is set (Menu 6-1) and setpoint toggle is disabled (Menu 3-3).
3	Not used with this controller type
4 Alarm	Move to menu 2-4 Special case: Move to menu 2-4-1 when single-zone operation is set (Menu 6-1) and setpoint toggle is disabled (Menu 3-3).
5 Frame Heater	Move to menu 2-5

- Menu 2-1 Cooling

COOLING POS: XXXXX	
1 Zone 1	Menu 2-1-1
2	Not used with this controller type
3 Zone 1A Altern.	Menu 2-1-3 Not shown when setpoint toggle is disabled (Menu 3-3)

- Menu 2-1-1 Zone 1

COOLING 1 POS: XXXXX		Entry	Default
Setpoint R2.x XXX °C	Supply air temperature setpoint	-10..20	-2 °C
Hysteresis R2.x X K	Supply air temperature hysteresis setpoint	1..8	4 K
Setpoint R4.x XXX °C	Return air temperature setpoint for comparison	-4..20	5 °C
Hysteresis R4.x X K	Return air temperature hysteresis setpoint	1..8	2 K

- Menu 2-1-2
Not used with this controller type
- Menu 2-1-3 Zone 1A Altern.

COOLING 1A POS: XXXXX		Entry	Default
Setpoint R2.x XXX °C	Supply air temperature setpoint	-10..20	0 °C
Hysteresis R2.x X K	Supply air temperature hysteresis setpoint	1..8	4 K
Setpoint R4.x XXX °C	Return air temperature setpoint for comparison	-4..20	5 °C
Hysteresis R4.x X K	Return air temperature hysteresis setpoint	1..8	2 K

- Menu 2-2 Defrost

Eckelmann

DEFROST POS: XXXXX	
1 Zone 1	Menu 2-2-1
2	Not used with this controller type
3 Zone 1A Altern.	Menu 2-2-3 Not shown when setpoint toggle is disabled (Menu 3-3)

- Menu 2-2-1 Zone 1

DEFROST 1 POS: XXXXX		Entry	Default
Def. End. Tmp. XX °C	Defrost termination temperature setpoint	--, 5..20	8 °C
M/S Degiv.Fct. XXX	Configuration of the defrost via CAN bus function. For details see chapter Master-Slave-Modus - Abtau-Synchronisation über CAN-Bus .	OFF, MASTR, SLAVE	OFF
M/S CAN Adr. XXX	Selection of the controller (1..99) participating in the defrost via CAN bus which is the master. "--", if this controller is itself master(Parameter <i>M/S Degiv.Fct.</i> = MASTR)	---, 1..99	–
DS-Function XXX	Configuration of the defrost sequence function (DS).For details see chapter Folgeabtauung (FA) über CAN-Bus .	OFF, MASTR, SLAVE	OFF
DS-Group XXX	Selection of which group a defrost sequence of this controller (1..99) belongs to.	---, 1..99	–
DS-Master XXX	Selection of which controller (1..99) participating in the defrost sequence is the master. "--", if this controller is itself the master(Parameter <i>DS-Function</i> = MASTR)	---, 1..99	–
DS-Wait time XXXm	Wait time for the defrost sequence	0..127	1 min

- Menu 2-2-2 Zone 2
Not used with this controller type.
- Menu 2-2-3 Zone 1A Altern.

DEFROST 1A POS: XXXXX		Entry	Default
Def. End. Tmp. XX °C	Defrost termination temperature setpoint	--, 5..20	5 °C

- Menu 2-3
Not used with this controller type.
- Menu 2-4 Alarm

ALARM POS: XXXXX	
1 Zone 1	Menu 2-4-1
2	Not used with this controller type
3 Zone 1A Altern.	Menu 2-4-3 Not shown when setpoint toggle is disabled (Menu 3-3)

- Menu 2-4-1 Zone 1

ALARM 1 POS: XXXXX		Entry	Default
High Temp Setp XX °C	High temperature setpoint at which <i>High Temperature</i> alarm is generated	0..30	8 °C
Low Temp Setp. XX K	Low temperature setpoint (difference below temperature control setpoint) at which <i>Low Temperature</i> alarm is generated	--, 0..6	4 K

Eckelmann

- Menu 2-4-2 Zone 2
Not used with this controller type
- Menu 2-4-3 Zone 1A Altern.

ALARM 1A POS: XXXXX		Entry	Default
High Temp Setp XX °C	High temperature setpoint at which <i>High Temperature</i> alarm is generated	0..30	8 °C
Low Temp Setp. XX K	Low temperature setpoint (difference below temperature control setpoint) at which <i>Low Temperature</i> alarm is generated	--, 0..6	4 K

- Menu 2-5 Frame Heater

FRAME HTR POS: XXXXX	
1 Mode altern.	Move to menu 2-5-1
2 Setpoint frm htr	Move to menu 2-5-2
3 Mode altern.	Move to menu 2-5-3 Not shown when setpoint toggle is disabled (Menu 3-3)
4 Setpoint altern.	Move to menu 2-5-4 Not shown when setpoint toggle is disabled (Menu 3-3)

- Menu 2-5-1 Mode altern.

Select between values. Checkmark shows current setting.

MODE POS: XXXXX		Entry	Default
fixed run time ✓	Fixed frame heater on time	↵	✓
enthalpy-ctrl rtm	Enthalpy control by ambient air temperature and humidity	↵	

- Menu 2-5-2 Setpoint frame heater

SETPOINTS POS: XXXXX		Entry	Default
Mod: xxxxxxxxxxxx	Displays set frame heater mode (Menu 2-5-1)		Fixed on time
Run Time XXX %	Fixed on time, Only shown when mode set to Fixed On Time (Menu 2-5-1)	--, 0..100	100 %
emerg.run time XXX %	On time in failure of ambient air humidity or temperature signal (via CAN bus) Only shown when mode set to Enthalpy Control (Menu 2-5-1)	--, 0..100	100 %
enthalp. offs. XXX %	Offset to on time with activated enthalpy control (via CAN bus) Only shown when mode set to Enthalpy Control (Menu 2-5-1)	-50..50	0 %
Invert Output xxx	Inversion of the function of the frame heater output (terminal 91/92)	↑, ↓, (ON/OFF)	ON

Eckelmann

- Menu 2-5-3 Mode altern.

Select between values. Checkmark shows current setting.

MODE ALT POS: XXXXX		Entry	Default
fixed run time ✓	Fixed frame heater on time	↵	✓
enthalpy-ctrl rtm	Enthalpy control by ambient air temperature and humidity	↵	

- Menu 2-5-4 Setpoint altern.

SOLLW. UM POS: XXXXX		Entry	Default
Mod: xxxxxxxxxxxx	Displays set frame heater mode (Menu 2-5-3)		Fixed on time
Run Time XXX %	Fixed on time, Only shown when mode set to Fixed On Time (Menu 2-5-3)	--, 0..100	100 %
emerg.run time XXX %	On time in failure of ambient air humidity or temperature signal (via CAN bus) Only shown when mode set to Enthalpy Control (Menu 2-5-3)	--, 0..100	100 %
enthalp. offs. XXX %	Offset to on time with activated enthalpy control (via CAN bus) Only shown when mode set to Enthalpy Control (Menu 2-5-3)	-50..50	0 %

9.2.4 Menu 3 Clock UA 111 D

CLOCK POS: XXXXX	
1 Current Time	Move to menu 3-1
2 Defrost timer	Move to menu 3-2
3 Toggle Setpoints	Move to menu 3-3

- Menu 3-1 Current Time

 Time is defined by time master (system centre / store computer / operator terminal) when CAN bus is connected. Any entry made will then be overwritten by the defined value.

CLOCK POS: XXXXX		Entry	Default
Date: XX dd.mm.yy	Display and enter current weekday, date	dd.mm.yy	
Time: hh.mm	Display and enter current time	hh.mm	
Daylight Saving X	Display and enter automatic daylight saving change (Y/N)	↑, ↓, (Y/N)	J

- Menu 3-2 Defrost timer

DERF. TIMER POS: XXXXX		Entry	Default
Defrost timer XXX	Defrost initiation via input D11/12 (EXT) or internal (INT)	↑, ↓, (EXT, INT)	INT
Safe Defr Time XXX m	Safe defrost time for maximum allowed duration of defrosting (used only for internal defrosting)	0..120	60 min
Manual Defrost XXX	Status (OFF/ON) for supplementary manual defrosting *) shown only when parameter defrost timer = INT	↑, ↓, (ON/OFF)	OFF
Def.Tim.Z2	Separate defrost timer for zone 2	Menu 3-2-a	
Defr. 1 xxxxx hh:mm	Defrost start time with internal defrosting; Weekday, time; shown only when parameter defrost timer = INT	↑, ↓, (Mo-Su etc.) or numbers (hh:mm)	Mo-Su01:00
Defr. 2 xxxxx hh:mm	Defrost start time with internal defrosting; Weekday, time; shown only when parameter defrost timer = INT	↑, ↓, (Mo-Su etc.) or numbers (hh:mm)	Mo-Su07:00
Defr. 3 xxxxx hh:mm	Defrost start time with internal defrosting; Weekday, time; shown only when parameter defrost timer = INT	↑, ↓, (Mo-Su etc.) or numbers (hh:mm)	Mo-Su13:00

DERF. TIMER POS: XXXXX		Entry	Default
Defr. 4 xxxxx hh:mm	Defrost start time with internal defrosting; Weekday, time; shown only when parameter defrost timer = INT	↑ , ↓ , (Mo-Su etc.) or numbers (hh:mm)	Mo-Su20:00
...			
Defr. 14 xxxxx hh:mm			

 *) Parameter automatically set to ON for safe defrost time at first start.

• Menu 3-2-a Def.Tim.Z2

DEFR.TIMER POS: XXXXX		Entry	Default
Defrost Timer XXX	Setting for how temperature zone 2 should defrost:- MitZ1 Together with zone 1- INT Internally- EXT Externally – the defrost of both temperature zones is started simultaneously via the external signal	↑ , ↓ (ViaZ1(ViaZ1,EXT,INT)	ViaZ1
Safe Defr Time XXX m	Safe defrost time, i.e. max. allowed duration of defrosting (internal defrost only)	0..120	60 min
Manual Defrost XXX	Status (ON/OFF) of auxiliary manual defrost *)	↑ , ↓ , (ON/OFF)	OFF
Defr. 1 xxxxx hh:mm	Defrost start time for internal defrost; weekday, time of day; shown only when parameter <i>defrost timer</i> = INT	↑ , ↓ , (Mo-Su) or numbers (hh:mm)	Mo-Su01:00
...			
Defr. 14 xxxxx hh:mm			

Eckelmann

• Menu 3-3 Toggle Setpoints

TOGGLE POS: XXXXX		Entry	Default
Status XXX	Setpoint toggle status (OFF/ON) of alternative set of setpoints (setpoint toggle)		
Toggle Setp. XXX	Setpoint toggle via <ul style="list-style-type: none"> EXT digital input D21/22 INT internal timer CAN bus- „-“ deactivated 	↑ , ↓ , (EXT, INT, CAN, --)	EXT
Blind On Time X s	Fan and cooling stop time after toggling to alternative set of setpoints with external setpoint toggle (Menu 3-3)	0..250	50 sec
Alt ON: DD-DD hh:mm	Start time for toggle to alternative set of setpoints Weekday from - to XXXXX, time hh:mm Only shown when internal setpoint toggle is activated (Menu 3-3)	↑ , ↓ , (Mo-Su etc.) or numbers (hh:mm)	Mo-Su 21:00
Alt OFF: DD-DD hh:mm	End time for toggle to alternative set of setpoints Weekday from - to XXXXX, time hh:mm Only shown when internal setpoint toggle is activated (Menu 3-3)	↑ , ↓ , (Mo-Su etc.) or numbers (hh:mm)	Mo-Su 05:00
Alt ON: DD-DD hh:mm	Start time for toggle to alternative set of setpoints Weekday from - to XXXXX, time hh:mm Only shown when internal setpoint toggle is activated (Menu 3-3)	↑ , ↓ , (Mo-Su etc.) or numbers (hh:mm)	Su 05:00
Alt OFF: DD-DD hh:mm	End time for toggle to alternative set of setpoints Weekday from - to XXXXX, time hh:mm Only shown when internal setpoint toggle is activated (Menu 3-3)	↑ , ↓ , (Mo-Su etc.) or numbers (hh:mm)	Su 21:00
...	A total of 7 different ON and OFF toggle times can be defined. A toggle time will only be obeyed when a <u>matched pair</u> of on and off times is set as a parameter.		

9.2.5 Menu 4 Messages UA 111 D

MESSAGES POS: XXXXX	
1 View	Move to menu 4-1: Show Message Log
2 Acknowledge	Messages in message log are cancelled. <i>"Alarms Cancelled!"</i> shown in display: Press ESC to go back.
3 Delete	Move to menu 4-2: Delete Message Log (with prompt)

- Menu 4-1 View Messages

MESSAGES POS: XXXXX	
Error Message 1:	Fault 1 message text
dd.mm.yy hh:mm ON	Start of Fault 1
dd.mm.yy hh:mm OFF	End of Fault 1 (only when Fault 1 terminated)
...	
Error Message n:	Fault n message text
dd.mm.yy hh:mm ON	Start of Fault n
dd.mm.yy hh:mm OFF	End of Fault n (only when Fault n terminated)

- Menu 4-2 Acknowledge Messages
This displays the *"Alarms Cancelled!"* message.
- Menu 4-3 Delete Messages

MESSAGES POS: XXXXX	
Delete! Are you sure? No: ESC YES: ↵	Safety prompt for deleting messages Press ESC to go back after cancelling messages.

9.2.6 Menu 5 Archive UA 111 D

ARCHIVE POS: XXXXX	
dd.mm.yy hh:mm	Time of archiving Record 1
Zone 1: abcdef x °C	Status and temperature of Zone 1, see Note
...	
dd.mm.yy hh:mm	Time of archiving Record n
Zone 1: abcdef x °C	Status and temperature of Zone 1, see Note

 *) Status abcdef covers following states of refrigeration point. The entry at this position is - when a state is not active. Example Zone 1: abcdef x °C

	Single-zone operation resp. Operator interface BT 300	Two-zone operation
a	O = Operation	O = Operation
b	R = Refrigeration / Cooling	R = Refrigeration / Cooling
c	R = Refrigeration/ Cooling	D = Defrost
d	D = Defrost	G = Gate / Door (cold-room controller only)
e	G = Gate / Door (cold-room controller only)	A = Alarm
f	A = Alarm	

9.2.7 Menu 6 Configuration UA 111 D

CONFIGURAT POS: XXXXX	
1 Refriger. Point	Move to menu 6-1
2 Controller	Move to menu 6-2
3 Cooling	Move to menu 6-3
4 Language	Move to menu 6-4
5 Alarm priorities	Move to menu 6-5
6 Em.Powersupply	Move to menu 6-6
7 Enhanced	Move to menu 6-7

- Menu 6-1 Refriger. Point

REFR. PT. POS: XXXXX		Entry	Default
Refr. Pt. Name:	Text only		
xxxxxxxxxxxxxxxx	Free text entry describing refrigeration point (see note)		Kühlstellenregler
Item ID: XXXXX	Free text entry displayed in screens after ITEM ID (see note)		UA400
Priority: XX	Alarm priority in failure of refrigeration point or when global controller priority is set (Menu 6-5)	↑, ↓, or numbers (0..99)	1
Refr. Sys. No.: XX	No. of pack controller allocated to case/cold-room controller	↑, ↓, or numbers (--, 1..9)	1
Refr. Sys. Type XXX	Associated compressor pack. Parameter only required when linked to a VS 3010 BS having several zones. If a different type of pack controller is used, set this parameter blank (---)	↑, ↓, or numbers (---, Z1, Z2)	—
Temp. Zones X	Number of temperature zones only Single-zone operation possible	↑, ↓, or numbers (1, 2)	1
No. Sensors XX	Number of temperature sensors connected. After entering ↵ sensor scan is performed to redetermine the number of sensorium of sensors	↵	

⚠ The priority must be assigned between 0..2 by older versions of the store computer (<V5.0), see chapter [Alarms and Messages of UA 400](#).

- ① A meaningful name that describes the refrigeration point in more detail should be entered, e.g. Cheese Counter 2 and CC2. Entry is made in the screens on system centre, store computer or operator terminal. Direct entry cannot be made in the controller screens displayed on the operator terminal. Entry cannot be made either on operator interface BT 300.

- Menu 6-2 Controller

CONTROLLER POS: XXXXX	
1 Type and Version	Move to menu 6-2-1
2 Temp. Display	Move to menu 6-2-2
3 Alarm Delay	Move to menu 6-2-3
4 230V Inputs	Move to menu 6-2-4
5 Sensor Type	Move to menu 6-2-5

- Menu 6-2-1 Type and Version

VERSION POS: XXXXX		Entry	Default
Ctrlr. Type XXXXXXXX	Controller type set by DIP Switch S3	–	UA111D
Software Ver.: XXXX	Software version of case/cold-room controller	–	x.yy
Serial No.: XXXXXXX	Device No. of case/cold-room controller	–	
Master/Sl. Mode XXX	Synchronized defrosting in master-slave mode (ON/OFF)	–	

- Menu 6-2-2 Temp. Display

DISPLAY POS: XXXXX		Entry	Default
Offset XX K	Offset for temperature display	-10..10	0K
Alarm symbol X	Show alarm symbol on BT 30 Temperature Display	↑, ↓, (Y/N)	N

- Menu 6-2-3 Alarm Delay

ALARMDELAY POS: XXXXX		Entry	Default
Sensor Fault XX m	Sensor break alarm delay	0..30	15 min
High/Low Temp. XX m	High/low temperature alarm delay	0..150	60 min
No Defrost XX h	No defrost alarm delay	--, 2..168	24 h
Selfholding X	NO: Automatic reset of non- transient alarms. YES: Alarms must be reset manually.	↑, ↓, (Y/N)	N

- Menu 6-2-4 230V Inputs

 Only trained personnel should be allowed to change inputs, as changes may affect other functions.

230V INPUT POS: XXXXX		Entry	Default
Entry1: XXXXXXXXXXXX	Function of digital input 1 D11/D12	1)	DEFR.TIMER
Entry2: XXXXXXXXXXXX	Function of digital input 2 D21/D22	2)	TOGGLE SETP.
Entry3: XXXXXXXXXXXX	Function of digital input 3 D31/D32	3)	MANUAL OFF.
Entry4: XXXXXXXXXXXX	Function of digital input 4 D41/D42	4)	Extern.Alarm
XXXXXXXXXXXXXXXXXXXX	Freely configurable alarm text for digital input 4, the default text is "CO2-Alarm"	Text	CO2-ALARM
Inv. D1 XXX	Inverting of digital input 1	↑ , ↓ , (ON/OFF)	OFF
Inv. D2 XXX	Inverting of digital input 2		OFF
Inv. D3 XXX	Inverting of digital input 3		OFF
Inv. D4 XXX	Inverting of digital input 4		OFF

Possible settings for the digital inputs:

1. DEFR.TIMER Defrost timer*
 MANUAL OFF. Manual shutoff both zones
 MANUAL OFF. Z1 Manual shutoff only Z1
 MANUAL OFF. Z2 Manual shutoff only
 Z2 TOGGLE SETP. Toggle setpoint
2. TOGGLE SETP Toggle setpoint *
 MANUAL OFF Manual shutoff both zones
 MANUAL OFF. Z1 Manual shutoff only Z1
 MANUAL OFF. Z2 Manual shutoff only Z2
3. MANUAL OFF Manual shutoff both zones *
 MANUAL OFF. Z1 Manual shutoff only Z1
 MANUAL OFF. Z2 Manual shutoff only Z2
4. EXT ALARM External Alarm *
 MANUAL OFF Manual shutoff both zones
 MANUAL OFF. Z1 Manual shutoff only Z1
 MANUAL OFF. Z2 Manual shutoff only Z2
 TOGGLE SETP Toggle setpoint

*Factory setting

Eckelmann

- Menu 6-2-5 Sensor Type

Select between values. Checkmark shows current setting.

SENSORS POS: XXXXX		Entry	Default
L243 ✓	Temperature range -50..50°C	↩	✓
K277	Temperature range -50..50°C	↩	
5K3A1	Temperature range 0..100°C	↩	

- Menu 6-3 Cooling

COOLING POS: XXXXX		Entry	Default
Min. On Time XX K	Minimum cooling ON time	0..15	2 m
Min. Off Time XX m	Minimum cooling OFF time	0..15	2 m
Delay 2nd Comp x m	Delay time 2nd compressor	0..15	3 m
Cont Cool Mon. xx m	Duration of forced interruption of cooling in continuous running	--, 0..15	0 m
Emergency Op. xx m	In failure of required sensors, the solenoid valve is actuated to adjust to the set opening in %.	0..100	40%

- Menu 6-4 Language

LANGUAGE POS: XXXXX	Entry	Default
Deutsch D ✓	↩	✓
English GB	↩	
Francais F	↩	
Espagnol E	↩	
Finnish FIN	↩	
Türkce TR	↩	
Cesky CZ	↩	

- Menu 6-5 Alarm priorities

ALARMPRIOS POS: XXXXX		Entry	Default
Prio.Refrig. Pt. X	Global alarm priority by refrigeration point priority (Menu 6-1) (Y)	↑ ↓ , (Y,N)	N
Priority: XX	Show refrigeration point priority (Menu 6-1) Only shown when refrigeration point priority set to Y.		
<p><i>Following parameters are only shown when refrigeration point priority is set to N. Meaning of usable entries for alarm priority: -=Event ignored 0=Message (entered only in message log) 1=Priority 1 alarm..99=Priority 99 alarm</i></p>			
Low Temp.	Temperature below lower alarm limit Priority applies to following alarms: Low Temp. Zone1, Low Temp. Zone2	-, 0..99	2
High Temp.	Temperature above upper alarm limit Priority applies to following alarms: High Temp. Zone1, High Temp. Zone2	-, 0..99	1
Sensor Fault	Temperature sensor failure	-, 0..99	2
No Defrost	No defrost within alarm delay interval Priority applies to following alarm: No defrost	-, 0..99	2
Timer-Term.Defr.	Defrosting terminated by safe defrost time	-, 0..99	0
Power Failure	Start following power failure	-, 0..99	0
First Start	Controller start up (basic settings loaded!)	-, 0..99	2
Manual Shutoff	Manual switch Input D31/D32 set OFF	-, 0..99	0
Hardware Fault	Internal hardware fault Priority applies to following alarms: EEPROM Fault, RTC Fault, Flash Fault	-, 0..99	1
Setpoint Change	Message generated on changing setpoint	-, 0..99	0
Refrig.Pt.Dis.	Cooling by pack controller via CAN bus interrupted	-, 0..99	0
Battery Voltage	Battery low	-, 0..99	0

- Menu 6-6 Em.Powersupply (Emergency Power supply)

EM.POW.SUP POS: XXXXX	Entry	Default	
Cool.funct.OFF xxx	Functionality of the cooling switched off during emergency power supply? (Y/N)	↑ , ↓ , (Y/N)	N
Defr.funct.OFF xxx	Functionality of the defrosting switched off during emergency power supply? (Y/N)	↑ , ↓ , (Y/N)	N
Fan funct. OFF xxx	Functionality of the fan switched off during emergency power supply? (Y/N)	↑ , ↓ , (Y/N)	N
Frame fct.OFF xxx	Functionality of the frame heater off during emergency power supply? (Y/N)	↑ , ↓ , (Y/N)	N
Light fct. OFF xxx	Functionality of the light during emergency power supply? (Y/N)	↑ , ↓ , (Y/N)	N

- Menu 6-7 Enhanced

ENHANCED POS: XXXXX	
1 SDS TEV	Move to menu 6-7-1
2 Service Mode	Move to menu 6-7-2

- Menu 6-7-1 SDS TEV

SDS TEV POS: XXXXX		Entry	Default
SDS TEV xx m	Principle participation of the controller in the suction pressure shift. (function COPT+). Note: This is transmitted via a CAN bus telegram and intervenes in the regulation!	↑ , ↓ , (ON/OFF)	OFF
Inact.a.Def xx m	Delay time following completion of the defrost before the controller actively intervenes in the shift.	0..40	30 min,
Dely_HystON xxxxm	Delay time for the reduction request with active cooling and overshoot of the hysteresis.	0..10	2.5 min
HiTmpZ1 dwn xxm	Delay time before the elapse of the high temperature alarm delay in zone 1, before the reduction is requested.	0..15	5 min.
HiTmpZ2 dwn xxm	Delay time before the elapse of the high temperature alarm delay in zone 2, before the reduction is requested.	0..15	5 min.
ToOvHystZ1 xxK	Tolerance limit above the setpoint plus hysteresis in zone 1. Influences when it is switched from stop to reduce.	0..20	2 K
ToOvHystZ2 xxK	Tolerance limit above the setpoint plus hysteresis in zone 2. Influences when it is switched from stop to reduce.	0..20	2 K
SwchSupRet xxx	Switching from supply air to return air and the reverse with temperature alarm delay time.	↑ , ↓ , (ON/OFF)	OFF
Dely_Switch xxxm	Switching from supply to return air: determines when it is switched within the delay time for the high temperature alarm.	0..15	5 min.
Add.Values xxx	Creation of additional (additive) "Debug" actual value archives in the system centre / store computer. Warning: This can force a reorganisation of the actual value archives – for this reason only use when required!	↑ , ↓ , (ON/OFF)	OFF
Incl_UpLim xxxK	Upper limit of the neutral zone for determining the incline.	0..5	0.3 K
Incl_LwLim xxxK	Lower limit of the neutral zone for determining the incline.	0..5	0.2 K

- Menu 6-7-2 Service Mode

SERVICIE MOD POS: XXXXX		Entry	Default
Relay 1 x	Relay 1 (terminal 15/16/18) switch on or off (1 or 0)	0 / 1	0
Relay 2 x	Relay 2 (terminal 25/26/28) switch on or off (1 or 0)	0 / 1	0
Relay 3 x	Relay 3 (terminal 35/36/38) switch on or off (1 or 0)	0 / 1	0
Relay 4 x	Relay 4 (terminal 43/44) switch on or off (1 or 0)	0 / 1	0
Relay 5 x	Relay 5 (terminal 53/54) switch on or off (1 or 0)	0 / 1	0
Relay 6 x	Relay 6 (terminal 64/65) switch on or off (1 or 0)	0 / 1	0
Relay 7 x	Relay 7 (terminal 73/74) switch on or off (1 or 0)	0 / 1	0
24V Out 1 x	Transistor output 1 (terminal 81/82) switch on or off (24 VDC / 50 mA)	0 / 1	0
24V Out 2 x	Transistor output 2 (terminal 91/92) switch on or off (24 VDC / 50 mA)	0 / 1	0
ANA OUT 1 xxxV	Analog output 1 (terminal 29/30) Default 0..10 VDC	0..10	0.0V
ANA OUT 2 xxxV	Analog output 2 (terminal 31/32) Default 0..10 VDC	0..10	0.0V
ANA IN 1 xxmA	Power analog input 1 (terminal 11/12) 4..20 mA	4..20	mA
ANA IN 2 xxmA	Power analog input 2 (terminal 11/14) 4..20 mA	4..20	mA
InputD 1 xxx	Status digital input 1 ON = 230 V AC voltage connected OFF = no voltage present	ON/OFF	-
InputD 2 xxx	Status digital input 2 ON = 230 V AC voltage connected OFF = no voltage present	ON/OFF	-
InputD 3 xxx	Status digital input 3 ON = 230 V AC voltage connected OFF = no voltage present	ON/OFF	-
InputD 4 xxx	Status digital input 4 ON = 230 V AC voltage connected OFF = no voltage present	ON/OFF	-

9.3 Controller type UA 121 - menu tree

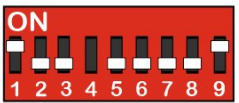
DIP switch S3	UA 121
	1: ON 2: OFF 3: OFF 4: ON/OFF = Master / Slave mode ON/OFF 5..8: OFF 9: ON

Main menu	Submenu	Submenu 2	Menu number	Menu name
			0	REFRIGERATION POINT
Actual values			1	ACTUAL VALUES
	Temperature sensor		1-1	TEMPERATURE
	Cooling Zone 1		1-2	COOLING 1
	Defrost Zone 1		1-3	DEFROST 1
	–			
	Alarm		1-5	ALARM
	Frame heater		1-6	FRAME HEATER
	Cooling Zone 2		1-7	COOLING 2
	Defrost Zone 2		1-8	DEFROST 2
Setpoints			2	SETPOINTS
	Cooling		2-1	COOLING
		Zone 1	2-1-1	COOLING 1
		Zone 2	2-1-2	COOLING 2
		Zone 1 U Umschalt.	2-1-3	COOLING 1U
		Zone 2 U Umschalt.	2-1-4	COOLING 2U
	Defrost		2-2	DEFROST
		Zone 1	2-2-1	DEFROST 1
		Zone 2	2-2-2	DEFROST 2
		Zone 1 U Umschalt.	2-2-3	DEFROST 1U
		Zone 2 U Umschalt.	2-2-4	DEFROST 2U
	–			

	Alarm		2-4	ALARM	
		Zone 1	2-4-1	ALARM 1	
		Zone 2	2-4-2	ALARM 2	
		Zone 1 U Umschalt.	2-4-3	ALARM 1U	
		Zone 2 U Umschalt.	2-4-4	ALARM 2U	
	Frame heater			2-5	RAHMENHEIZ
		Frame heater mode		2-5-1	FRAME HEATER
		Frame heater setpoints		2-5-2	SETPOINTS
		Toggle mode		2-5-3	RAHMEN UM.
		Toggle setpoints		2-5-4	SOLLW. UM.
Clock			3	CLOCK	
	current time		3-1	CLOCK	
	Defrost timer		3-2	DEFROST TIMER	
		Abt.Uhr Z2	3-2-a	ABT.UHR Z2	
	Toggle setpoints		3-3	UMSCHALTNG	
Messages			4	MESSAGES	
	view		4-1	MESSAGES	
	acknowledge		4-2		
	delete		4-3	MESSAGES	
Archive			5	ARCHIVE	
Configuration			6	KONFIGURAT	
	Refrigeration point		6-1	REFRIGERATION POINT	
	Controller		6-2	CONTROLLER	
		Type and version	6-2-1	VERSION	
		Temperature display	6-2-2	DISPLAY	
		Alarm delay	6-2-3	ALARMVERZ.	
		230 V inputs	6-2-4	230 V INPUTS	
		Sensor type	6-2-5	SENSOR TYPE	
	Cooling		6-3	COOLING	

Language		6-4	LANGUAGE
Alarm priorities		6-5	ALARMPRIOS
Emergency power operation		6-6	NOTNETZ
Advanced		6-7	ADVANCED
	SDS TEV	6-7-1	SDS TEV
	Service Mode	6-7-2	SERVICE MOD

9.3.1 Main menu UA 121

REFR. PT. POS: XXXXX	
1 Actual Values	Move to menu 1
2 Setpoints	Move to menu 2
3 Clock	Move to menu 3
4 Messages	Move to menu 4
5 Archive	Move to menu 5
6 Configuration	Move to menu 6

9.3.2 Menu 1 Actual Values UA 121

ACT VALUES POS: XXXXX	
1 Temp. Sensor	Move to menu 1-1
2 Cooling Zone 1	Move to menu 1-2
3 Defrost Zone 1	Move to menu 1-3
4	Not used with this controller type
5 Alarm	Move to menu 1-5
6 Frame Heater	Move to menu 1-6
7 Cooling Zone 2	Move to menu 1-7 Only shown when two-zone operation is set (Menu 6-1)
8 Defrost Zone 2	Move to menu 1-8 Only shown when two-zone operation is set (Menu 6-1)

- Menu 1-1 Temp. Sensor

TEMPERATUR Pos: XXXXX	
Temp. R2.1 xxx °C	Current supply air temperature Input Z11/ Z12
Temp. R4.1 xxx °C	Current return air temperature Input Z21/ Z22
Temp. R1.1 xxx °C	Current evaporator defrost termination temperature Input Z31/ Z32
Temp. R4.2 xxx °C	Current return air temperature Input Z41/ Z42
Temp. R1.2 xxx °C	Current evaporator defrost termination temperature Input Z51/ Z52
Temp. R2.3 xxx °C	Current supply air temperature Input Z61/ Z62
Temp. R4.3 xxx °C	Current return air temperature Input Z71/ Z72
Temp. R1.3 xxx °C	Current evaporator defrost termination temperature Input Z81/ Z82
Temp. R4.4 xxx °C	Current return air temperature Input Z91/ Z92
Temp. R1.4 xxx °C	Current evaporator defrost termination temperature Input Z01/ Z02

- Menu 1-2 Cooling Zone 1

COOLING 1 Pos: XXXXX	
Cooling xxx	Current ON/OFF status of cooling
Run Time xx %	Cooling relay on time during last day (00:00 - 24:00 hours)
Starts 0	Cooling relay actuations during last day
Temp. R2.1 xxx °C	Current supply air temperature Input Z11/Z12

COOLING 1 Pos: XXXXX	
Setpoint R2.1 xxx °C	Supply air temperature setpoint for comparison
Hystersis R2.1 xxx K	Supply air temperature hysteresis setpoint
Temp. R4.1 xxx °C	Current return air temperature Input Z21/Z22
Setpoint R4.1 xxx °C	Return air temperature setpoint for comparison
Hystersis R4.1 xxx K	Return air temperature hysteresis setpoint

- Menu 1-3 Defrost Zone 1

DEFROST 1 Pos: XXXXX	
Defrost XXX	Current ON/OFF status of defrosting
Temp. R1.1 XXX °C	Current supply air temperature Input Z31/Z32
Temp. R1.2 XXX °C	Current supply air temperature Input Z51/Z52
Def. End. Tmp. XXX °C	Defrost termination temperature for comparison
Wait Time xx m	Waiting time setpoint
Drip Time xx m	Drain time setpoint
Last Defrost XX hh:mm	Day and time of last defrost cycle started
M/S Nof. Sl.	Number of parameterised and accessible MA slaves
M/S Lost Sl.	CAN address of the first MA slave which was not accessible during the last defrost
M/S DeFr.Sl.	Number of slaves currently undergoing a defrost
M/S DSIMat	List of MA slaves currently undergoing a defrost (can be scrolled through using ENTER)
DSq Nof. Sl.	Number of DS slaves (only in the case of DS master)
DSq Lost Sl.	CAN address of the first FA slave which was not accessible during the last defrost
DSq DeFr.Sl.	Number of slaves currently undergoing defrost
DSq DSIMat	List of FA slaves currently undergoing a defrost (can be scrolled through using ENTER)

- Menu 1-4
Not used with this controller type.
- Menu 1-5 Alarm

ALARM Pos: XXXXX	
Alarm Relay XXX	Current ON/OFF status of alarm output Terminal 15/16/18
Hi Temp Setp.1 XX °C	High temperature setpoint Zone 1
Lo Temp Setp.1 XX K	Low temperature setpoint Zone 1
Hi Temp Setp.2 XX °C	High temperature setpoint Zone 2; Only shown when two-zone operation is set (Menu 6-1)
Lo Temp Setp.2 XX K	Low temperature setpoint Zone 2; Only shown when two-zone operation is set (Menu 6-1)

- Menu 1-6 Frame Heater

Eckelmann

MODE XXXXX	
Frame Heater xxx	Current ON/OFF status of frame heater output Terminal 91/92/93
Run Time xxx %	Current on time of frame heater
Humidity xxx %	Current ambient air humidity (transmitted via CAN bus from pack controller with fitted ambient humidity sensor)
Room temp xx °C	Current ambient air temperature (transmitted via CAN bus from pack controller with fitted ambient temperature sensor)

- Menu 1-7 Cooling Zone 2

COOLING 2 XXXXX	
Cooling XXX	Current ON/OFF status of cooling
Run Time XX %	Cooling relay on time during last day (00:00 - 24:00 hours)
Starts 0	Cooling relay actuations during last day
Temp. R2.3 XXX °C	Current supply air temperature Input Z61/Z62
Setpoint R2.3 XXX °C	Supply air temperature setpoint for comparison
Hystersis R2.3 XXX K	Supply air temperature hysteresis setpoint
Temp. R4.3 XXX °C	Current return air temperature Input Z71/Z72
Setpoint R4.3 XXX °C	Return air temperature setpoint for comparison
Hystersis R4.3 XXX K	Return air temperature hysteresis setpoint

- Menu 1-8 Defrost Zone 2

DEFROST 2 Pos: XXXXX	
Defrost XXX	Current ON/OFF status of defrosting
Temp. R1.3 XXX °C	Current supply air temperature Input Z81/Z82
Temp. R1.4 XXX °C	Current supply air temperature Input Z01/Z02
Def. End. Tmp. XXX °C	Defrost termination temperature for comparison
Wait Time xx m	Waiting time setpoint
Drip Time xx m	Drain time setpoint
Last Defrst XX hh:mm	Day and time of last defrost cycle started

9.3.3 Menu 2 Setpoints UA 121

SETPOINTS POS: XXXXX	
1 Cooling	Menu 2-1; Special case: Move to menu 2-1-1 when single-zone operation is set (Menu 6-1) and setpoint toggle is disabled (Menu 3-3).
2 Defrost	Menu 2-2; Special case: Move to menu 2-2-1 when single-zone operation is set (Menu 6-1) and setpoint toggle is disabled (Menu 3-3).
3	Not used with this controller type
4 Alarm	Menu 2-4; Special case: Move to menu 2-4-1. When single-zone operation is set (Menu 6-1) and setpoint toggle is disabled (Menu 3-3).
5 Frame Heater	Move to menu 2-5

- Menu 2-1 Cooling

COOLING POS: XXXXX	
1 Zone 1	Menu 2-1-1
2 Zone 2	Menu 2-1-2 Only shown when two-zone operation is set (Menu 6-1)
3 Zone 1A Altern.	Menu 2-1-3 Not shown when setpoint toggle is disabled (Menu 3-3)
4 Zone 2A Altern.	Menu 2-1-4 Only shown when two-zone operation is set (Menu 6-1) and setpoint toggle is not disabled (Menu 3-3)

- Menu 2-1-1 Zone 1

COOLING 1 POS: XXXXX		Entry	Default
Setpoint R2.1 XXX °C	Supply air temperature setpoint	-10..20	-2 °C
Hystersis R2.1 X K	Supply air temperature hysteresis setpoint	1..8	4 K
Setpoint R4.1 XXX °C	Return air temperature setpoint for comparison	-10..20	4 °C
Hystersis R4.1 X K	Return air temperature hysteresis setpoint	1..8	2 K

- Menu 2-1-2 Zone 2

COOLING 2 POS: XXXXX		Entry	Default
Setpoint R2.3 XXX °C	Supply air temperature setpoint	-10..20	-2 °C
Hystersis R2.3 X K	Supply air temperature hysteresis setpoint	1..8	4 K
Setpoint R4.3 XXX °C	Return air temperature setpoint for comparison	-10..20	4 °C
Hystersis R4.3 X K	Return air temperature hysteresis setpoint	1..8	2 K

- Menu 2-1-3 Zone 1A Altern.

COOLING 1A POS: XXXXX		Entry	Default
Setpoint R2.1 XXX °C	Supply air temperature setpoint	-10..20	0 °C
Hystersis R2.1 X K	Supply air temperature hysteresis setpoint	1..8	4 K
Setpoint R4.1 XXX °C	Return air temperature setpoint for comparison	-10..20	4 °C
Hystersis R4.1 X K	Return air temperature hysteresis setpoint	1..8	2 K

- Menu 2-1-4 Zone 2A Altern.

COOLING 2A POS: XXXXX		Entry	Default
Setpoint R2.3 XXX °C	Supply air temperature setpoint	-10..20	0 °C
Hystersis R2.3 X K	Supply air temperature hysteresis setpoint	1..8	4 K
Setpoint R4.3 XXX °C	Return air temperature setpoint for comparison	-10..20	4 °C
Hystersis R4.3 X K	Return air temperature hysteresis setpoint	1..8	2 K

- Menu 2-2 Defrost

DEFROST POS: XXXXX	
1 Zone 1	Menu 2-2-1
2 Zone 2	Menu 2-2-2 Only shown when two-zone operation is set (Menu 6-1)
3 Zone 1A Altern.	Menu 2-2-3 Not shown when setpoint toggle is disabled (Menu 3-3)
4 Zone 2A Altern.	Menu 2-2-4 Only shown when two-zone operation is set (Menu 6-1) and setpoint toggle is not disabled (Menu 3-3)

- Menu 2-2-1 Zone 1

DEFROST 1 POS: XXXXX		Entry	Default
Def. End. Tmp. XX °C	Defrost termination temperature setpoint	--, 5..20	8 °C
Wait Time xx m	Waiting time setpoint between cooling and defrosting	0 .. 15	0 m
Drip Time x m	Waiting time (drain time) setpoint between defrosting and cooling	0 .. 15	0 m
M/S Degiv.Fct. XXX	Configuration of the defrost via CAN bus function. For details see chapter Master-Slave-Modus - Abtau-Synchronisation über CAN-Bus.	OFF, MASTR, SLAVE	OFF
M/S CAN Adr. XXX	Selection of the controller (1..99) participating in the defrost via CAN bus which is the master. "--", if this controller is itself master (Parameter <i>M/S Degiv.Fct.</i> = MASTR)	---, 1..99	–
DS-Function XXX	Configuration of the defrost sequence function (DS). For details see chapter Folgeabtauung (FA) über CAN-Bus.	OFF, MASTR, SLAVE	OFF
DS-Group XXX	Selection of which group a defrost sequence of this controller (1..99) belongs to.	---, 1..99	–
DS-Master XXX	Selection of which controller (1..99) participating in the defrost sequence is the master. "--", if this controller is itself the master (Parameter <i>DS-Function</i> = MASTR)	---, 1..99	–

Eckelmann

DEFROST 1 POS: XXXXX		Entry	Default
DS-Wait time XXXm	Wait time for the defrost sequence	0..127	1 min

- Menu 2-2-2 Zone 2

DEFROST 2 POS: XXXXX		Entry	Default
Def. End. Tmp. XX °C	Defrost termination temperature setpoint	--, 5..20	8 °C
Wait Time xx m	Waiting time setpoint between cooling and defrosting	0 .. 15	0 m
Drip Time x m	Waiting time (drain time) setpoint between defrosting and cooling	0 .. 15	0 m

Eckelmann

- Menu 2-2-3 Zone 1A Altern.

DEFROST 1A POS: XXXXX		Entry	Default
Def. End. Temp. XX °C	Defrost termination temperature setpoint	--, 5..20	5 °C
Wait Time xx m	Waiting time setpoint between cooling and defrosting	0 .. 15	0 m
Drip Time x m	Waiting time (drain time) setpoint between defrosting and cooling	0 .. 15	0 m

- Menu 2-2-4 Zone 2A Altern.

DEFROST 2A POS: XXXXX		Entry	Default
Def. End. Temp. XX °C	Defrost termination temperature setpoint	--, 5..20	5 °C
Wait Time xx m	Waiting time setpoint between cooling and defrosting	0 .. 15	0 m
Drip Time x m	Waiting time (drain time) setpoint between defrosting and cooling	0 .. 15	0 m

- Menu 2-3
Not used with this controller type.
- Menu 2-4 Alarm

ALARM POS: XXXXX	
1 Zone 1	Menu 2-4-1
2 Zone 2	Menu 2-4-2 Only shown when two-zone operation is set (Menu 6-1)
3 Zone 1A Altern.	Menu 2-4-3 Not shown when setpoint toggle is disabled (Menu 3-3)
4 Zone 2A Altern.	Menu 2-4-4 Only shown when two-zone operation is set (Menu 6-1) and setpoint toggle is not disabled (Menu 3-3)

- Menu 2-4-1 Zone 1

ALARM 1 POS: XXXXX		Entry	Default
High Temp Setp XX °C	High temperature setpoint at which <i>High Temperature</i> alarm is generated	0..30	8 °C
Low Temp Setp. XX K	Low temperature setpoint (difference below temperature control setpoint) at which <i>Low Temperature</i> alarm is generated	--, 0..6	4 K

- Menu 2-4-2 Zone 2

ALARM 2 POS: XXXXX		Entry	Default
High Temp Setp XX °C	High temperature setpoint at which <i>High Temperature</i> alarm is generated	0..30	8 °C
Low Temp Setp. XX K	Low temperature setpoint (difference below temperature control setpoint) at which <i>Low Temperature</i> alarm is generated	--, 0..6	4 K

- Menu 2-4-3 Zone 1A Altern.

ALARM 1A POS: XXXXX		Entry	Default
High Temp Setp XX °C	High temperature setpoint at which <i>High Temperature</i> alarm is generated	0..30	8 °C
Low Temp Setp. XX K	Low temperature setpoint (difference below temperature control setpoint) at which <i>Low Temperature</i> alarm is generated	--, 0..6	4 K

- Menu 2-4-4 Zone 2A Altern.

ALARM 2A POS: XXXXX		Entry	Default
High Temp Setp XX °C	High temperature setpoint at which <i>High Temperature</i> alarm is generated	0..30	8 °C
Low Temp Setp. XX K	Low temperature setpoint (difference below temperature control setpoint) at which <i>Low Temperature</i> alarm is generated	--, 0..6	4 K

- Menu 2-5 Frame Heater

FRAME HTR POS: XXXXX	
1 Mode altern.	Move to menu 2-5-1
2 Setpoint frm htr	Move to menu 2-5-2
3 Mode altern.	Move to menu 2-5-3 Not shown when setpoint toggle is disabled (Menu 3-3)
4 Setpoint altern.	Move to menu 2-5-4 Not shown when setpoint toggle is disabled (Menu 3-3)

- Menu 2-5-1 Mode altern.

Select between values. Checkmark shows current setting.

MODE POS: XXXXX		Entry	Default
fixed run time ✓	Fixed frame heater on time	↵	✓
enthalpy-ctrl rtm	Enthalpy control by ambient air temperature and humidity	↵	

- Menu 2-5-2 Setpoint frame heater

Eckelmann

SETPOINTS POS: XXXXX		Entry	Default
Mod: xxxxxxxxxxxx	Displays set frame heater mode (Menu 2-5-1)		Fixed on time
Run Time XXX %	Fixed on time, Only shown when mode set to Fixed On Time (Menu 2-5-1)	--, 0..100	100 %
emerg.run time XXX %	On time in failure of ambient air humidity or temperature signal (via CAN bus) Only shown when mode set to Enthalpy Control (Menu 2-5-1)	--, 0..100	100 %
enthalp. offs. XXX %	Offset to on time with activated enthalpy control (via CAN bus) Only shown when mode set to Enthalpy Control (Menu 2-5-1)	-50..50	0 %
Invert Output xxx	Inversion of the function of the frame heater output(terminal 91/92)	↑ , ↓ , (ON/OFF)	ON

Eckelmann

- Menu 2-5-3 Mode altern.

Select between values. Checkmark shows current setting.

MODE ALT POS: XXXXX		Entry	Default
fixed run time ✓	Fixed frame heater on time	↵	✓
enthalpy-ctrl rtm	Enthalpy control by ambient air temperature and humidity	↵	

- Menu 2-5-4 Setpoint altern.

SOLLW. UM POS: XXXXX		Entry	Default
Mod: xxxxxxxxxxxx	Displays set frame heater mode (Menu 2-5-3)		Fixed on time
Run Time XXX %	Fixed on time, Only shown when mode set to Fixed On Time (Menu 2-5-3)	--, 0..100	100 %
emerg.run time XXX %	On time in failure of ambient air humidity or temperature signal (via CAN bus) Only shown when mode set to Enthalpy Control (Menu 2-5-3)	--, 0..100	100 %
enthalp. offs. XXX %	Offset to on time with activated enthalpy control (via CAN bus) Only shown when mode set to Enthalpy Control (Menu 2-5-3)	-50..50	0 %

9.3.4 Menu 3 Clock UA 121

CLOCK POS: XXXXX	
1 Current Time	Move to menu 3-1
2 Defrost timer	Move to menu 3-2
3 Toggle Setpoints	Move to menu 3-3

- Menu 3-1 Current Time



 Time is defined by time master (system centre / store computer / operator terminal) when CAN bus is connected. Any entry made will then be overwritten by the defined value.

CLOCK POS: XXXXX		Entry	Default
Date: XX dd.mm.yy	Display and enter current weekday, date	dd.mm.yy	
Time: hh.mm	Display and enter current time	hh.mm	
Daylight Saving X	Display and enter automatic daylight saving change (Y/N)	↑, ↓, (Y/N)	J

- Menu 3-2 Defrost timer

DERF. TIMER POS: XXXXX		Entry	Default
Defrost timer XXX	Defrost initiation via input D11/12 (EXT) or internal (INT)	↑, ↓, (EXT, INT)	INT
Safe Defr Time XXX m	Safe defrost time for maximum allowed duration of defrosting (used only for internal defrosting)	0..120	60 min
Manual Defrost XXX	Status (OFF/ON) for supplementary manual defrosting *) shown only when parameter defrost timer = INT	↑, ↓, (ON/OFF)	OFF
Def.Tim.Z2	Separate defrost timer for zone 2	Menu 3-2-a	
Defr. 1 xxxxx hh:mm	Defrost start time with internal defrosting; Weekday, time; shown only when parameter defrost timer = INT	↑, ↓, (Mo-Su etc.) or numbers (hh:mm)	Mo-Su 01:00
Defr. 2 xxxxx hh:mm	Defrost start time with internal defrosting; Weekday, time; shown only when parameter defrost timer = INT	↑, ↓, (Mo-Su etc.) or numbers (hh:mm)	Mo-Su 07:00
Defr. 3 xxxxx hh:mm	Defrost start time with internal defrosting; Weekday, time; shown only when parameter defrost timer = INT	↑, ↓, (Mo-Su etc.) or numbers (hh:mm)	Mo-Su 13:00

Eckelmann

DERF. TIMER POS: XXXXX		Entry	Default
Defr. 4 xxxxx hh:mm	Defrost start time with internal defrosting; Weekday, time; shown only when parameter defrost timer = INT	  , (Mo-Su etc.) or numbers (hh:mm)	Mo-Su 19:30
...			
Defr. 14 xxxxx hh:mm	Defrost start time with internal defrosting; Weekday, time; shown only when parameter defrost timer = INT		

 *) Parameter automatically set to ON for safe defrost time at first start.



• Menu 3-2-a Def.Tim.Z2

DEFR.TIMER POS: XXXXX		Entry	Default
Defrost Timer XXX	Setting for how temperature zone 2 should defrost:- MitZ1 Together with zone 1- INT Internally- EXT Externally – the defrost of both temperature zones is started simultaneously via the external signal	↑ ↓ (ViaZ1(ViaZ1,EXT,INT))	ViaZ1
Safe Defr Time XXX m	Safe defrost time, i.e. max. allowed duration of defrosting (internal defrost only)	0..120	60 min
Manual Defrost XXX	Status (ON/OFF) of auxiliary manual defrost *)	↑ ↓ , (ON/OFF)	OFF
Defr. 1 xxxxx hh:mm	Defrost start time for internal defrost; weekday, time of day; shown only when parameter <i>defrost timer</i> = INT	↑ ↓ , (Mo-Su) or numbers (hh:mm)	Mo-Su 01:00
...			
Defr. 14 xxxxx hh:mm			

• Menu 3-3 Toggle Setpoints

TOGGLE POS: XXXXX		Entry	Default
Status XXX	Setpoint toggle status (OFF/ON) of alternative set of setpoints (setpoint toggle)		
Toggle Setp. XXX	Setpoint toggle via <ul style="list-style-type: none"> EXT digital input D21/22 INT internal timer CAN bus- „-“ deactivated 	↑ ↓ , (EXT, INT, CAN, --)	EXT
Blind On Time X s	Fan and cooling stop time after toggling to alternative set of setpoints with external setpoint toggle (Menu 3-3)	0..250	50 sec
Alt ON: DD-DD hh:mm	Start time for toggle to alternative set of setpoints Weekday from - to XXXXX, time hh:mm Only shown when internal setpoint toggle is activated (Menu 3-3)	↑ ↓ , (Mo-Su etc.) or numbers (hh:mm)	Mo-Su 21:00
Alt OFF: DD-DD hh:mm	End time for toggle to alternative set of setpoints Weekday from - to XXXXX, time hh:mm Only shown when internal setpoint toggle is activated (Menu 3-3)	↑ ↓ , (Mo-Su etc.) or numbers (hh:mm)	Mo-Su 05:00
Alt ON: DD-DD hh:mm	Start time for toggle to alternative set of setpoints Weekday from - to XXXXX, time hh:mm Only shown when internal setpoint toggle is activated (Menu 3-3)	↑ ↓ , (Mo-Su etc.) or numbers (hh:mm)	Su 05:00

Eckelmann

TOGGLE POS: XXXXX		Entry	Default
Alt OFF: DD-DD hh:mm	End time for toggle to alternative set of setpoints Weekday from - to XXXXX, time hh:mm Only shown when internal setpoint toggle is activated (Menu 3-3)	 ,  , (Mo-Su etc.) or numbers (hh:mm)	Su 21:00
...	A total of 7 different ON and OFF toggle times can be defined. A toggle time will only be obeyed when a <u>matched pair</u> of on and off times is set as a parameter.		

9.3.5 Menu 4 Messages UA 121

MESSAGES POS: XXXXX	
1 View	Move to menu 4-1: Show Message Log
2 Acknowledge	Messages in message log are cancelled. <i>"Alarms Cancelled!"</i> shown in display: Press ESC to go back.
3 Delete	Move to menu 4-2: Delete Message Log (with prompt)

- Menu 4-1 View Messages

MESSAGES POS: XXXXX	
Error Message 1:	Fault 1 message text
dd.mm.yy hh:mm ON	Start of Fault 1
dd.mm.yy hh:mm OFF	End of Fault 1 (only when Fault 1 terminated)
...	
Error Message n:	Fault n message text
dd.mm.yy hh:mm ON	Start of Fault n
dd.mm.yy hh:mm OFF	End of Fault n (only when Fault n terminated)

- Menu 4-2 Acknowledge Messages
This displays the *"Alarms Cancelled!"* message.
- Menu 4-3 Delete Messages

MESSAGES POS: XXXXX		Entry
Delete! Are you sure? No: ESC YES: ↵	Safety prompt for deleting messages Press ESC to go back after cancelling messages.	↵, ESC

9.3.6 Menu 5 Archive UA 121

ARCHIVE POS: XXXXX	
dd.mm.yy hh:mm	Time of archiving Record 1
Zone 1: abcdef x °C	Status and temperature of Zone 1, see Note
Zone 2: abcdef x °C	Status and temperature of Zone 2, see Note Only shown when two-zone operation is set (Menu 6-1)
...	
dd.mm.yy hh:mm	Time of archiving Record n
Zone 1: abcdef x °C	Status and temperature of Zone 1, see Note
Zone 2: abcdef x °C	Status and temperature of Zone 2, see Note Only shown when two-zone operation is set (Menu 6-1)

 *) Status abcdef covers following states of refrigeration point. The entry at this position is - when a state is not active. Example Zone 1: abcdef x °C

	Single-zone operation resp. Operator interface BT 300	Two-zone operation
a	O = Operation	O = Operation
b	R = Refrigeration / Cooling	R = Refrigeration / Cooling
c	R = Refrigeration/ Cooling	D = Defrost
d	D = Defrost	G = Gate / Door (cold-room controller only)
e	G = Gate / Door (cold-room controller only)	A = Alarm
f	A = Alarm	

9.3.7 Menu 6 Configuration UA 121

CONFIGURAT POS: XXXXX	
1 Refriger. Point	Move to menu 6-1
2 Controller	Move to menu 6-2
3 Cooling	Move to menu 6-3
4 Language	Move to menu 6-4
5 Alarm priorities	Move to menu 6-5
6 Em.Powersupply	Move to menu 6-6
7 Enhanced	Move to menu 6-7

- Menu 6-1 Refriger. Point

REFR. PT. POS: XXXXX		Entry	Default
Refr. Pt. Name:	Text only		
xxxxxxxxxxxxxxxx	Free text entry describing refrigeration point (see note)		Kühlstellenregler
Item ID: XXXXX	Free text entry displayed in screens after ITEM ID (see note)		UA400
Priority: XX	Alarm priority in failure of refrigeration point or when global controller priority is set (Menu 6-5)	↑, ↓, or numbers (0..99)	1
Refr. Sys. No.: XX	No. of pack controller allocated to case/cold-room controller	↑, ↓, or numbers (--, 1..9)	1
Refr. Sys. Type XXX	Associated compressor pack. Parameter only required when linked to a VS 3010 BS having several zones. If a different type of pack controller is used, set this parameter blank (---)	↑, ↓, or numbers (---, Z1, Z2)	—
Temp. Zones X	Number of temperature zones Single-zone operation Two-zone operation	↑, ↓, or numbers (1, 2)	2
No. Sensors XX	Number of temperature sensors connected. After entering ↵ sensor scan is performed to redetermine the number of sensorium of sensors	↵	

⚠ The priority must be assigned between 0..2 by older versions of the store computer (<V5.0), see chapter [Alarms and Messages of UA 400](#).

- ① A meaningful name that describes the refrigeration point in more detail should be entered, e.g. Cheese Counter 2 and CC2. Entry is made in the screens on system centre, store computer or operator terminal. Direct entry cannot be made in the controller screens displayed on the operator terminal. Entry cannot be made either on operator interface BT 300.

- Menu 6-2 Controller

CONTROLLER POS: XXXXX	
1 Type and Version	Move to menu 6-2-1
2 Temp. Display	Move to menu 6-2-2
3 Alarm Delay	Move to menu 6-2-3
4 230V Inputs	Move to menu 6-2-4
5 Sensor Type	Move to menu 6-2-5

- Menu 6-2-1 Type and Version

VERSION POS: XXXXX		Entry	Default
Ctrlr. Type XXXXXXXX	Controller type set by DIP Switch S3	–	UA121
Software Ver.: XXXX	Software version of case/cold-room controller	–	x.yy
Serial No.: XXXXXXX	Device No. of case/cold-room controller	–	
Master/Sl. Mode XXX	Synchronized defrosting in master-slave mode (ON/OFF)	–	

- Menu 6-2-2 Temp. Display

DISPLAY POS: XXXXX		Entry	Default
Offset XX K	Offset for temperature display	-10..10	0K
Alarm symbol X	Show alarm symbol on BT 30 Temperature Display	↑, ↓, (Y/N)	N

- Menu 6-2-3 Alarm Delay

ALARMDELAY POS: XXXXX		Entry	Default
Sensor Fault XX m	Sensor break alarm delay	0..30	15 min
High/Low Temp. XX m	High/low temperature alarm delay	0..120	60 min
No Defrost XX h	No defrost alarm delay	--, 2..168	24 h
Selfholding X	NO: Automatic reset of non- transient alarms. YES: Alarms must be reset manually.	↑, ↓, (Y/N)	N

- Menu 6-2-4 230V Inputs

 Only trained personnel should be allowed to change inputs, as changes may affect other functions.

230V INPUT POS: XXXXX		Entry	Default
Entry1: XXXXXXXXXXXX	Function of digital input 1 D11/D12	1)	DEFR.TIMER
Entry2: XXXXXXXXXXXX	Function of digital input 2 D21/D22	2)	TOGGLE SETP.
Entry3: XXXXXXXXXXXX	Function of digital input 3 D31/D32	3)	MANUAL OFF.
Entry4: XXXXXXXXXXXX	Function of digital input 4 D41/D42	4)	Extern.Alarm
XXXXXXXXXXXXXXXXXXXXX	Freely configurable alarm text for digital input 4, the default text is "CO2-Alarm"	Text	CO2-ALARM
Inv. D1 XXX	Inverting of digital input 1	↑ , ↓ , (ON/OFF)	OFF
Inv. D2 XXX	Inverting of digital input 2		OFF
Inv. D3 XXX	Inverting of digital input 3		OFF
Inv. D4 XXX	Inverting of digital input 4		OFF

Possible settings for the digital inputs:

1. DEFR.TIMER Defrost timer*
 MANUAL OFF. Manual shutoff both zones
 MANUAL OFF. Z1 Manual shutoff only Z1
 MANUAL OFF. Z2 Manual shutoff only Z2
 TOGGLE SETP. Toggle setpoint
2. TOGGLE SETP Toggle setpoint *
 MANUAL OFF Manual shutoff both zones
 MANUAL OFF. Z1 Manual shutoff only Z1
 MANUAL OFF. Z2 Manual shutoff only Z2
3. MANUAL OFF Manual shutoff both zones *
 MANUAL OFF. Z1 Manual shutoff only Z1
 MANUAL OFF. Z2 Manual shutoff only Z2
4. EXT ALARM External Alarm *
 MANUAL OFF Manual shutoff both zones
 MANUAL OFF. Z1 Manual shutoff only Z1
 MANUAL OFF. Z2 Manual shutoff only Z2
 TOGGLE SETP Toggle setpoint

*Factory setting

Eckelmann

- Menu 6-2-5 Sensor Type

Select between values. Checkmark shows current setting.

SENSORS POS: XXXXX		Entry	Default
L243 ✓	Temperature range -50..50°C	↩	✓
K277	Temperature range -50..50°C	↩	
5K3A1	Temperature range 0..100°C	↩	

- Menu 6-3 Cooling

COOLING POS: XXXXX		Entry	Default
Min. On Time XX K	Minimum cooling ON time	0..15	2 m
Min. Off Time XX m	Minimum cooling OFF time	0..15	2 m
Cont Cool Mon. xx m	Duration of forced interruption of cooling in continuous running	--, 0..15	— m
Emergency Op. xx m	In failure of required sensors, the solenoid valve is actuated to adjust to the set opening in %.	0..100	40%

- Menu 6-4 Language

LANGUAGE POS: XXXXX	Entry	Default
Deutsch D ✓	↩	✓
English GB	↩	
Francais F	↩	
Espagnol E	↩	
Finnish FIN	↩	
Türkce TR	↩	
Cesky CZ	↩	

- Menu 6-5 Alarm priorities

ALARMPRIOS POS: XXXXX		Entry	Default
Prio.Refrig. Pt. X	Global alarm priority by refrigeration point priority (Menu 6-1) (Y)	↑, ↓, (Y,N)	N
Priority: XX	Show refrigeration point priority (Menu 6-1) Only shown when refrigeration point priority set to Y.		
<i>Following parameters are only shown when refrigeration point priority is set to N. Meaning of usable entries for alarm priority: -=Event ignored 0=Message (entered only in message log) 1=Priority 1 alarm..99=Priority 99 alarm</i>			
Low Temp.	Temperature below lower alarm limit Priority applies to following alarms: Low Temp. Zone1, Low Temp. Zone2	-, 0..99	2
High Temp.	Temperature above upper alarm limit Priority applies to following alarms: High Temp. Zone1, High Temp. Zone2	-, 0..99	1
Sensor Fault	Temperature sensor failure	-, 0..99	2
No Defrost	No defrost within alarm delay interval Priority applies to following alarm: No defrost	-, 0..99	2
Timer-Term.Defr.	Defrosting terminated by safe defrost time	-, 0..99	0
Power Failure	Start following power failure	-, 0..99	0
First Start	Controller start up (basic settings loaded!)	-, 0..99	2
Manual Shutoff	Manual switch Input D31/D32 set OFF	-, 0..99	0

Eckelmann

ALARMPRIOS POS: XXXXX		Entry	Default
Hardware Fault	Internal hardware fault Priority applies to following alarms: EEPROM Fault, RTC Fault, Flash Fault	-, 0..99	1
Setpoint Change	Message generated on changing setpoint	0..99	0
Refrig.Pt.Dis.	Cooling by pack controller via CAN bus interrupted	-, 0..99	0
Battery Voltage	Battery low	-, 0..99	0

- Menu 6-6 Em.Powersupply (Emergency Power supply)

EM.POW.SUP POS: XXXXX		Entry	Default
Cool.funct.OFF xxx	Functionality of the cooling switched off during emergency power supply? (Y/N)	↑ , ↓ , (Y/N)	N
Defr.funct.OFF xxx	Functionality of the defrosting switched off during emergency power supply? (Y/N)	↑ , ↓ , (Y/N)	N
Fan funct. OFF xxx	Functionality of the fan switched off during emergency power supply? (Y/N)	↑ , ↓ , (Y/N)	N
Frame fct.OFF xxx	Functionality of the frame heater off during emergency power supply? (Y/N)	↑ , ↓ , (Y/N)	N
Light fct. OFF xxx	Functionality of the light during emergency power supply? (Y/N)	↑ , ↓ , (Y/N)	N

- Menu 6-7 Enhanced

ENHANCED POS: XXXXX	
1 SDS TEV	Move to menu 6-7-1
2 Service Mode	Move to menu 6-7-2

- Menu 6-7-1 SDS TEV

SDS TEV POS: XXXXX		Entry	Default
SDS TEV xx m	Principle participation of the controller in the suction pressure shift. (function COPT+). Note: This is transmitted via a CAN bus telegram and intervenes in the regulation!	↑ , ↓ , (ON/OFF)	OFF
Inact.a.Def xx m	Delay time following completion of the defrost before the controller actively intervenes in the shift.	0..40	30 min,
Dely_HystON xxxxm	Delay time for the reduction request with active cooling and overshoot of the hysteresis.	0..10	2.5 min
HiTmpZ1 dwn xxm	Delay time before the elapse of the high temperature alarm delay in zone 1, before the reduction is requested.	0..15	5 min.
HiTmpZ2 dwn xxm	Delay time before the elapse of the high temperature alarm delay in zone 2, before the reduction is requested.	0..15	5 min.
TolOvHystZ1 xxK	Tolerance limit above the setpoint plus hysteresis in zone 1. Influences when it is switched from stop to reduce.	0..20	2 K
TolOvHystZ2 xxK	Tolerance limit above the setpoint plus hysteresis in zone 2. Influences when it is switched from stop to reduce.	0..20	2 K
SwchSupRet xxx	Switching from supply air to return air and the reverse with temperature alarm delay time.	↑ , ↓ , (ON/OFF)	OFF
Dely_Switch xxxm	Switching from supply to return air: determines when it is switched within the delay time for the high temperature alarm.	0..15	5 min.
Add.Values xxx	Creation of additional (additive) "Debug" actual value archives in the system centre / store computer. Warning: This can force a reorganisation of the actual value archives – for this reason only use when required!	↑ , ↓ , (ON/OFF)	OFF
Incl_UpLim xxxK	Upper limit of the neutral zone for determining the incline.	0..5	0.3 K
Incl_LwLim xxxK	Lower limit of the neutral zone for determining the incline.	0..5	0.2 K

- Menu 6-7-2 Service Mode

SERVICIE MOD POS: XXXXX		Entry	Default
Relay 1 x	Relay 1 (terminal 15/16/18) switch on or off (1 or 0)	0 / 1	0
Relay 2 x	Relay 2 (terminal 25/26/28) switch on or off (1 or 0)	0 / 1	0
Relay 3 x	Relay 3 (terminal 35/36/38) switch on or off (1 or 0)	0 / 1	0
Relay 4 x	Relay 4 (terminal 43/44) switch on or off (1 or 0)	0 / 1	0
Relay 5 x	Relay 5 (terminal 53/54) switch on or off (1 or 0)	0 / 1	0
Relay 6 x	Relay 6 (terminal 64/65) switch on or off (1 or 0)	0 / 1	0
Relay 7 x	Relay 7 (terminal 73/74) switch on or off (1 or 0)	0 / 1	0
24V Out 1 x	Transistor output 1 (terminal 81/82) switch on or off (24 VDC / 50 mA)	0 / 1	0
24V Out 2 x	Transistor output 2 (terminal 91/92) switch on or off (24 VDC / 50 mA)	0 / 1	0
ANA OUT 1 xxxV	Analog output 1 (terminal 29/30) Default 0..10 VDC	0..10	0.0V
ANA OUT 2 xxxV	Analog output 2 (terminal 31/32) Default 0..10 VDC	0..10	0.0V
ANA IN 1 xxmA	Power analog input 1 (terminal 11/12) 4..20 mA	4..20	mA
ANA IN 2 xxmA	Power analog input 2 (terminal 11/14) 4..20 mA	4..20	mA
InputD 1 xxx	Status digital input 1 ON = 230 V AC voltage connected OFF = no voltage present	ON/OFF	-
InputD 2 xxx	Status digital input 2 ON = 230 V AC voltage connected OFF = no voltage present	ON/OFF	-
InputD 3 xxx	Status digital input 3 ON = 230 V AC voltage connected OFF = no voltage present	ON/OFF	-
InputD 4 xxx	Status digital input 4 ON = 230 V AC voltage connected OFF = no voltage present	ON/OFF	-

9.4 Controller type UA 131 / UA 131 LS - menu tree

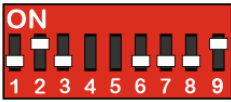
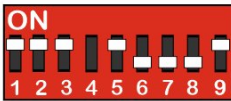
DIP switch S3	UA 131
	1: OFF 2: ON 3: OFF 4: ON/OFF = Master / Slave mode ON/OFF 5: ON: With inverted fan control OFF: Defrost 4 6..8: OFF 9: ON
DIP switch S3	UA 131 LS
	1: ON 2: ON 3: ON 4: ON/OFF = Master / Slave mode ON/OFF 5: ON = with enhanced fan control = UA 131 LS 6..7: OFF 8: OFF 9: ON

Main menu	Submenu	Submenu 2	Menu number	Menu name
			0	REFRIGERATION POINT
Actual values			1	ACTUAL VALUES
	Temperature sensor		1-1	TEMPERATURE
	Cooling Zone 1		1-2	COOLING 1
	Defrost Zone 1		1-3	DEFROST 1
	–			
	Alarm		1-5	ALARM
	Frame heater		1-6	FRAME HEATER
	Cooling Zone 2		1-7	COOLING 2
	Defrost Zone 2		1-8	DEFROST 2
Setpoints			2	SETPOINTS
	Cooling		2-1	COOLING
		Zone 1	2-1-1	COOLING 1
		Zone 2	2-1-2	COOLING 2
		Zone 1 U Umschalt.	2-1-3	COOLING 1U
		Zone 2 U Umschalt.	2-1-4	COOLING 2U
	Defrost		2-2	DEFROST
		Zone 1	2-2-1	DEFROST 1

		Zone 2	2-2-2	DEFROST 2
		Zone 1 U Umschalt.	2-2-3	DEFROST 1U
		Zone 2 U Umschalt.	2-2-4	DEFROST 2U
	-			
	Alarm		2-4	ALARM
		Zone 1	2-4-1	ALARM 1
		Zone 2	2-4-2	ALARM 2
		Zone 1 U Umschalt.	2-4-3	ALARM 1U
	Alarm	Zone 2 U Umschalt.	2-4-4	ALARM 2U
	Frame heater		2-5	RAHMENHEIZ
		Frame heater mode	2-5-1	FRAME HEATER
		Frame heater setpoints	2-5-2	SETPOINTS
		Toggle mode	2-5-3	RAHMEN UM.
		Toggle setpoints	2-5-4	SOLLW. UM.
	Condenser Fans		2-6	CONDENSER FANS
		Zone 1+2	2-6-1	FAN 1
		Zone 1+2Umschalt	2-6-2	LÜFTER 1U
Clock			3	CLOCK
	current time		3-1	CLOCK
	Defrost timer		3-2	DEFROST TIMER
		Abt.Uhr Z2	3-2-a	ABT.UHR Z2
	Toggle setpoints		3-3	UMSCHALTNG
Messages			4	MESSAGES
	view		4-1	MESSAGES
	acknowledge		4-2	
	delete		4-3	MESSAGES
Archive			5	ARCHIVE
Configuration			6	KONFIGURAT
	Refrigeration point		6-1	REFRIGERATION POINT

Controller		6-2	CONTROLLER
	Type and version	6-2-1	VERSION
	Temperature display	6-2-2	DISPLAY
	Alarm delay	6-2-3	ALARMVERZ.
	230 V inputs	6-2-4	230 V INPUTS
	Sensor type	6-2-5	SENSOR TYPE
Cooling		6-3	COOLING
Language		6-4	LANGUAGE
Alarm priorities		6-5	ALARMPRIOS
Emergency power operation		6-6	NOTNETZ
Advanced		6-7	ADVANCED
	SDS TEV	6-7-1	SDS TEV
	Service Mode	6-7-2	SERVICE MOD

9.4.1 Main menu UA 131 / UA 131 LS

REFR. PT. POS: XXXXX	
1 Actual Values	Move to menu 1
2 Setpoints	Move to menu 2
3 Clock	Move to menu 3
4 Messages	Move to menu 4
5 Archive	Move to menu 5
6 Configuration	Move to menu 6

9.4.2 Menu 1 Actual Values UA 131 / UA 131 LS

ACT VALUES POS: XXXXX	
1 Temp. Sensor	Move to menu 1-1
2 Cooling Zone 1	Move to menu 1-2
3 Defrost Zone 1	Move to menu 1-3
4	Not used with this controller type
5 Alarm	Move to menu 1-5
6 Frame Heater	Move to menu 1-6
7 Cooling Zone 2	Move to menu 1-7 Only shown when two-zone operation is set (Menu 6-1)
8 Defrost Zone 2	Move to menu 1-8 Only shown when two-zone operation is set (Menu 6-1)

- Menu 1-1 Temp. Sensor

TEMPERATUR Pos: XXXXX	
Temp. R2.1 xxx °C	Current supply air temperature Input Z11/ Z12
Temp. R4.1 xxx °C	Current return air temperature Input Z21/ Z22
Temp. R1.1 xxx °C	Current evaporator defrost termination temperature Input Z31/ Z32
Temp. R4.2 xxx °C	Current return air temperature Input Z41/ Z42
Temp. R1.2 xxx °C	Current evaporator defrost termination temperature Input Z51/ Z52
Temp. R2.3 xxx °C	Current supply air temperature Input Z61/ Z62
Temp. R4.3 xxx °C	Current return air temperature Input Z71/ Z72
Temp. R1.3 xxx °C	Current evaporator defrost termination temperature Input Z81/ Z82
Temp. R4.4 xxx °C	Current return air temperature Input Z91/ Z92
Temp. R1.4 xxx °C	Current evaporator defrost termination temperature Input Z01/ Z02

- Menu 1-2 Cooling Zone 1

COOLING 1 Pos: XXXXX	
Cooling xxx	Current ON/OFF status of cooling
Run Time xx %	Cooling relay on time during last day (00:00 - 24:00 hours)
Starts 0	Cooling relay actuations during last day
Temp. R2.1 xxx °C	Current supply air temperature Input Z11/Z12

Eckelmann

COOLING 1 Pos: XXXXX	
Setpoint R2.1 xxx °C	Supply air temperature setpoint for comparison
Hystersis R2.1 xxx K	Supply air temperature hysteresis setpoint
Temp. R4.1 xxx °C	Current return air temperature Input Z21/Z22
Setpoint R4.1 xxx °C	Return air temperature setpoint for comparison
Hystersis R4.1 xxx K	Return air temperature hysteresis setpoint

- Menu 1-3 Defrost Zone 1

DEFROST 1 Pos: XXXXX	
Counting Rate	Counting rate
Defrost Counter	Defrost counter
Defr. Relay 1	Defrost Relay 1
Temp. R1.1 XXX °C	Current supply air temperature Input Z31/Z32
Defr. Relay 2	Defrost Relay 2
Temp. R1.2 XXX °C	Current supply air temperature Input Z51/Z52
Def. End. Tmp. XXX °C	Defrost termination temperature for comparison
Wait Time xx m	Waiting time setpoint
Drip Time xx m	Drain time setpoint
Last Defrst XX hh:mm	Day and time of last defrost cycle started
M/S Nof. Sl.	Number of parameterised and accessible MA slaves
M/S Lost Sl.	CAN address of the first MA slave which was not accessible during the last defrost
M/S Defr.Sl.	Number of slaves currently undergoing a defrost
M/S DSIMat	List of MA slaves currently undergoing a defrost (can be scrolled through using ENTER)
DSq Nof. Sl.	Number of DS slaves (only in the case of DS master)
DSq Lost Sl.	CAN address of the first FA slave which was not accessible during the last defrost
DSq Defr.Sl.	Number of slaves currently undergoing defrost
DSq DSIMat	List of FA slaves currently undergoing a defrost (can be scrolled through using ENTER)

- Menu 1-4
Not used with this controller type.
- Menu 1-5 Alarm

ALARM Pos: XXXXX	
Alarm Relay XXX	Current ON/OFF status of alarm output Terminal 15/16/18
Hi Temp Setp.1 XX °C	High temperature setpoint Zone 1
Lo Temp Setp.1 XX K	Low temperature setpoint Zone 1
Hi Temp Setp.2 XX °C	High temperature setpoint Zone 2; Only shown when two-zone operation is set (Menu 6-1)

Eckelmann

ALARM Pos: XXXXX	
Lo Temp Setp.2 XX K	Low temperature setpoint Zone 2; Only shown when two-zone operation is set (Menu 6-1)

- Menu 1-6 Frame Heater

MODE XXXXX	
Frame Heater xxx	Current ON/OFF status of frame heater output Terminal 91/92/93
Run Time xxx %	Current on time of frame heater
Humidity xxx %	Current ambient air humidity (transmitted via CAN bus from pack controller with fitted ambient humidity sensor)
Room temp xx °C	Current ambient air temperature (transmitted via CAN bus from pack controller with fitted ambient temperature sensor)

- Menu 1-7 Cooling Zone 2

COOLING 2 XXXXX	
Cooling XXX	Current ON/OFF status of cooling
Run Time XX %	Cooling relay on time during last day (00:00 - 24:00 hours)
Starts 0	Cooling relay actuations during last day
Temp. R2.3 XXX °C	Current supply air temperature Input Z61/Z62
Setpoint R2.3 XXX °C	Supply air temperature setpoint for comparison
Hystersis R2.3 XXX K	Supply air temperature hysteresis setpoint
Temp. R4.3 XXX °C	Current return air temperature Input Z71/Z72
Setpoint R4.3 XXX °C	Return air temperature setpoint for comparison
Hystersis R4.3 XXX K	Return air temperature hysteresis setpoint

- Menu 1-8 Defrost Zone 2

DEFROST 2 Pos: XXXXX	
Counting Rate	Counting rate
Defrost Counter	Defrost counter
Defr. Relay 3	Defrost Relay 3
Temp. R1.3 XXX °C	Current supply air temperature Input Z81/Z82
Defr. Relay 4	Defrost Relay 4
Temp. R1.4 XXX °C	Current supply air temperature Input Z01/Z02
Def. End. Tmp. XXX °C	Defrost termination temperature for comparison
Wait Time xx m	Waiting time setpoint
Drip Time xx m	Drain time setpoint
Last Defrst XX hh:mm	Day and time of last defrost cycle started

9.4.3 Menu 2 Setpoints UA 131 / UA 131 LS

SETPOINTS POS: XXXXX	
1 Cooling	Menu 2-1; Special case: Move to menu 2-1-1 when single-zone operation is set (Menu 6-1) and setpoint toggle is disabled (Menu 3-3).
2 Defrost	Menu 2-2; Special case: Move to menu 2-2-1 when single-zone operation is set (Menu 6-1) and setpoint toggle is disabled (Menu 3-3).
3	Not used with this controller type
4 Alarm	Menu 2-4; Special case: Move to menu 2-4-1 when single-zone operation is set (Menu 6-1) and setpoint toggle is disabled (Menu 3-3).
5 Frame Heater	Move to menu 2-5
6 Fans	Move to menu 2-6 (Menu only shown when the case controller is configured to UA 131 with fan control (further details in the chapter UA 400 installation and start-up):

- Menu 2-1 Cooling

COOLING POS: XXXXX	
1 Zone 1	Menu 2-1-1
2 Zone 2	Menu 2-1-2 Only shown when two-zone operation is set (Menu 6-1)
3 Zone 1A Altern.	Menu 2-1-3 Not shown when setpoint toggle is disabled (Menu 3-3)
4 Zone 2A Altern.	Menu 2-1-4 Only shown when two-zone operation is set (Menu 6-1) and setpoint toggle is not disabled (Menu 3-3)

- Menu 2-1-1 Zone 1

COOLING 1 POS: XXXXX		Entry	Default
Setpoint R2.1 XXX °C	Supply air temperature setpoint	-40..20	-32 °C
Hysteresis R2.1 X K	Supply air temperature hysteresis setpoint	1..8	2 K
Setpoint R4.1 XXX °C	Return air temperature setpoint for comparison	-30..20	-20 °C
Hysteresis R4.1 X K	Return air temperature hysteresis setpoint	1..8	2 K

- Menu 2-1-2 Zone 2

COOLING 2 POS: XXXXX		Entry	Default
Setpoint R2.3 XXX °C	Supply air temperature setpoint	-40..20	-32 °C
Hysteresis R2.3 X K	Supply air temperature hysteresis setpoint	1..8	2 K
Setpoint R4.3 XXX °C	Return air temperature setpoint for comparison	-30..20	-20 °C
Hysteresis R4.3 X K	Return air temperature hysteresis setpoint	1..8	2 K

- Menu 2-1-3 Zone 1A Altern.

COOLING 1A POS: XXXXX		Entry	Default
Setpoint R2.1 XXX °C	Supply air temperature setpoint	-40..20	-32 °C
Hystersis R2.1 X K	Supply air temperature hysteresis setpoint	1..8	2 K
Setpoint R4.1 XXX °C	Return air temperature setpoint for comparison	-30..20	-22 °C
Hystersis R4.1 X K	Return air temperature hysteresis setpoint	1..8	2 K

- Menu 2-1-4 Zone 2A Altern.

COOLING 2A POS: XXXXX		Entry	Default
Setpoint R2.3 XXX °C	Supply air temperature setpoint	-40..20	-32 °C
Hystersis R2.3 X K	Supply air temperature hysteresis setpoint	1..8	2 K
Setpoint R4.3 XXX °C	Return air temperature setpoint for comparison	-30..20	-22 °C
Hystersis R4.3 X K	Return air temperature hysteresis setpoint	1..8	2 K

- Menu 2-2 Defrost

DEFROST POS: XXXXX	
1 Zone 1	Menu 2-2-1
2 Zone 2	Menu 2-2-2 Only shown when two-zone operation is set (Menu 6-1)
3 Zone 1A Altern.	Menu 2-2-3 Not shown when setpoint toggle is disabled (Menu 3-3)
4 Zone 2A Altern.	Menu 2-2-4 Only shown when two-zone operation is set (Menu 6-1) and setpoint toggle is not disabled (Menu 3-3)

- Menu 2-2-1 Zone 1

DEFROST 1 POS: XXXXX		Entry	Default
Counting Rate	Counting rate	0..15	3
Defrost Counter	Defrost counter	-	1
Def. End. Tmp. XX °C	Defrost termination temperature setpoint	--, 0..20	10 °C
Wait Time xx m	Waiting time setpoint between cooling and defrosting	0 .. 15	3 m
Drip Time x m	Waiting time (drain time) setpoint between defrosting and cooling	0 .. 15	5 m
M/S Degiv.Fct. XXX	Configuration of the defrost via CAN bus function. For details see chapter Master-Slave-Modus - Abtau-Synchronisation über CAN-Bus .	OFF, MASTR, SLAVE	OFF
M/S CAN Adr. XXX	Selection of the controller (1..99) participating in the defrost via CAN bus which is the master. "--", if this controller is itself master (Parameter <i>M/S Degiv.Fct.</i> = MASTR)	---, 1..99	–
DS-Function XXX	Configuration of the defrost sequence function (DS).For details see chapter Folgeabtauung (FA) über CAN-Bus .	OFF, MASTR, SLAVE	OFF
DS-Group XXX	Selection of which group a defrost sequence of this controller (1..99) belongs to.	---, 1..99	–
DS-Master XXX	Selection of which controller (1..99) participating in the defrost sequence is the master. "--", if this controller is itself the master (Parameter <i>DS-Function</i> = MASTR)	---, 1..99	–
DS-Wait time XXXm	Wait time for the defrost sequence	0..127	1 min

- Menu 2-2-2 Zone 2

DEFROST 2 POS: XXXXX		Entry	Default
Counting Rate	Counting rate	0..15	3
Defrost Counter	Defrost counter	-	1
Def. End. Tmp. XX °C	Defrost termination temperature setpoint	--, 0..20	10 °C
Wait Time xx m	Waiting time setpoint between cooling and defrosting	0 .. 15	3 m
Drip Time x m	Waiting time (drain time) setpoint between defrosting and cooling	0 .. 15	5 m

Eckelmann

- Menu 2-2-3 Zone 1A Altern.

DEFROST 1A POS: XXXXX		Entry	Default
Counting Rate	Counting rate	0..15	3
Defrost Counter	Defrost counter	-	1
Def. End. Tmp. XX °C	Defrost termination temperature setpoint	--, 0..20	10 °C
Wait Time xx m	Waiting time setpoint between cooling and defrosting	0 .. 15	3 m
Drip Time x m	Waiting time (drain time) setpoint between defrosting and cooling	0 .. 15	5 m

- Menu 2-2-4 Zone 2A Altern.

DEFROST 2A POS: XXXXX		Entry	Default
Counting Rate	Counting rate	0..15	3
Defrost Counter	Defrost counter	-	1
Def. End. Tmp. XX °C	Defrost termination temperature setpoint	--, 0..20	10 °C
Wait Time xx m	Waiting time setpoint between cooling and defrosting	0 .. 15	3 m
Drip Time x m	Waiting time (drain time) setpoint between defrosting and cooling	0 .. 15	5 m

- Menu 2-3

Not used with this controller type.

- Menu 2-4 Alarm

ALARM POS: XXXXX	
1 Zone 1	Menu 2-4-1
2 Zone 2	Menu 2-4-2 Only shown when two-zone operation is set (Menu 6-1)
3 Zone 1A Altern.	Menu 2-4-3 Not shown when setpoint toggle is disabled (Menu 3-3)
4 Zone 2A Altern.	Menu 2-4-4 Only shown when two-zone operation is set (Menu 6-1) and setpoint toggle is not disabled (Menu 3-3)

- Menu 2-4-1 Zone 1

ALARM 1 POS: XXXXX		Entry	Default
High Temp Setp XX °C	High temperature setpoint at which <i>High Temperature</i> alarm is generated	-20..30	-12 °C
Low Temp Setp. XX K	Low temperature setpoint (difference below temperature control setpoint) at which <i>Low Temperature</i> alarm is generated	--, 0..6	4 K

Eckelmann

- Menu 2-4-2 Zone 2

ALARM 2 POS: XXXXX		Entry	Default
High Temp Setp XX °C	High temperature setpoint at which <i>High Temperature</i> alarm is generated	-20..30	-12 °C
Low Temp Setp. XX K	Low temperature setpoint (difference below temperature control setpoint) at which <i>Low Temperature</i> alarm is generated	--, 0..6	4 K

- Menu 2-4-3 Zone 1A Altern.

ALARM 1A POS: XXXXX		Entry	Default
High Temp Setp XX °C	High temperature setpoint at which <i>High Temperature</i> alarm is generated	-20..30	-14 °C
Low Temp Setp. XX K	Low temperature setpoint (difference below temperature control setpoint) at which <i>Low Temperature</i> alarm is generated	--, 0..6	4 K

- Menu 2-4-4 Zone 2A Altern.

ALARM 2A POS: XXXXX		Entry	Default
High Temp Setp XX °C	High temperature setpoint at which <i>High Temperature</i> alarm is generated	-20..30	-14 °C
Low Temp Setp. XX K	Low temperature setpoint (difference below temperature control setpoint) at which <i>Low Temperature</i> alarm is generated	--, 0..6	4 K

- Menu 2-5 Frame Heater

FRAME HTR POS: XXXXX	
1 Mode altern.	Move to menu 2-5-1
2 Setpoint frm htr	Move to menu 2-5-2
3 Mode altern.	Move to menu 2-5-3 Not shown when setpoint toggle is disabled (Menu 3-3)
4 Setpoint altern.	Move to menu 2-5-4 Not shown when setpoint toggle is disabled (Menu 3-3)

- Menu 2-5-1 Mode altern.

Select between values. Checkmark shows current setting.

MODE POS: XXXXX		Entry	Default
fixed run time	Fixed frame heater on time	↙	
enthalpy-ctrl rtm	Enthalpy control by ambient air temperature and humidity	↙	
set point-ctrl rtm ✓	Setpoint-dependent control of frame heater	↙	✓

- Menu 2-5-2 Setpoint frame heater

SETPOINTS POS: XXXXX		Entry	Default
Mod: xxxxxxxxxxxxx	Displays set frame heater mode (Menu 2-5-1)		Fixed on time
Run Time XXX %	Fixed on time, Only shown when mode set to Fixed On Time (Menu 2-5-1)	--, 0..100	100 %
emerg.run time XXX %	On time in failure of ambient air humidity or temperature signal (via CAN bus) Only shown when mode set to Enthalpy Control (Menu 2-5-1)	--, 0..100	100 %
enthalp. offs. XXX %	Offset to on time with activated enthalpy control (via CAN bus) Only shown when mode set to Enthalpy Control (Menu 2-5-1)	-50..50	0 %
Mod: set point-ctrl	Setpoint-dependent control of frame heater Only shown when mode set to Setpoint-Dependent On Time (Menu 2-5-1)	-	-
Invert Output xxx	Inversion of the function of the frame heater output (terminal 91/92)	↑, ↓, (ON/OFF)	ON

- Menu 2-5-3 Mode altern.

Select between values. Checkmark shows current setting.

MODE ALT POS: XXXXX		Entry	Default
fixed run time	Fixed frame heater on time	↙	
enthalpy-ctrl rtm	Enthalpy control by ambient air temperature and humidity	↙	
set point-ctrl rtm ✓	Setpoint-dependent control of frame heater	↙	✓

- Menu 2-5-4 Setpoint altern.

SOLLW. UM POS: XXXXX		Entry	Default
Mod: xxxxxxxxxxxxx	Displays set frame heater mode (Menu 2-5-3)		Fixed on time
Run Time XXX %	Fixed on time, Only shown when mode set to Fixed On Time (Menu 2-5-3)	--, 0..100	100 %
emerg.run time XXX %	On time in failure of ambient air humidity or temperature signal (via CAN bus) Only shown when mode set to Enthalpy Control (Menu 2-5-3)	--, 0..100	100 %
enthalp. offs. XXX %	Offset to on time with activated enthalpy control (via CAN bus) Only shown when mode set to Enthalpy Control (Menu 2-5-3)	-50..50	0 %
Mod: set point-ctrl	Setpoint-dependent control of frame heater Only shown when mode set to Setpoint-Dependent On Time (Menu 2-5-1)	-	-

Eckelmann

- Menu 2-6 Fans

Menus 2-6 / 2-6-1 / 2-6-2 are only shown when the case controller is configured to UA 131 with fan control (further details in the chapter [UA 400 installation and start-up](#)):

Controller type UA 131: with fan control

FANS POS: XXXXX	
1 Zone 1+2	Move to menu 2-6-1
2 Zone 1+2 Altern.	Move to menu 2-6-2

Controller type UA 131 LS: with advanced fan control

Menu 2-6 only shown when the case controller is configured to *UA 131 LS with advanced fan control* (further details in the chapter [UA 400 installation and start-up](#)):

FANS POS: XXXXX		Entry	Default
Op.mode: XXXXXXXXXXXXX	Possible operating modes: Continuous operation, Forerun, Overrun	CONTINUOUSFORERUNOVERR UNDEL.A.DEFR.	CONTINUOUS
Fan delay	Continuous operation mode: not relevant Forerun mode: not relevant Overrun mode: Fan on by undershoot of temperature at evaporator sensor Delay after defrost mode: Fan on by undershoot of temperature at evaporator sensor	--, -30..30	-5 °C
Fan hightemp.	Continuous operation mode: not relevant Forerun mode: fan on when temperature at evaporator sensor exceeded Overrun mode: fan off when temperature at evaporator sensor exceeded Delay after defrost mode: not relevant	--, -30..30	-5 °C

- Menu 2-6-1 Zone 1+2

FANS 1 POS: XXXXX		Entry	Default
Fans Start xx °C	Setpoint at which fan is activated	--, -30..30	-5 °C

- Menu 2-6-2 Zone 1+2 Altern.

FANS 1A POS: XXXXX		Entry	Default
Fans Start xx °C	Setpoint at which fan is activated	--, -30..30	-5 °C

9.4.4 Menu 3 Clock UA 131 / UA 131 LS

CLOCK POS: XXXXX	
1 Current Time	Move to menu 3-1
2 Defrost timer	Move to menu 3-2
3 Toggle Setpoints	Move to menu 3-3

- Menu 3-1 Current Time

 Time is defined by time master (system centre / store computer / operator terminal) when CAN bus is connected. Any entry made will then be overwritten by the defined value.

CLOCK POS: XXXXX		Entry	Default
Date: XX dd.mm.yy	Display and enter current weekday, date	dd.mm.yy	
Time: hh.mm	Display and enter current time	hh.mm	
Daylight Saving X	Display and enter automatic daylight saving change (Y/N)	↑, ↓, (Y/N)	J

- Menu 3-2 Defrost timer

DERF. TIMER POS: XXXXX		Entry	Default
Defrost timer XXX	Defrost initiation via input D11/12 (EXT) or internal (INT)	↑, ↓, (EXT, INT)	INT
Safe Defr Time XXX m	Safe defrost time for maximum allowed duration of defrosting (used only for internal defrosting)	0..120	60 min
Manual Defrost XXX	Status (OFF/ON) for supplementary manual defrosting *) shown only when parameter defrost timer = INT	↑, ↓, (ON/OFF)	OFF
Def.Tim.Z2	Separate defrost timer for zone 2	Menu 3-2-a	
Defr. 1 xxxxx hh:mm	Defrost start time with internal defrosting; Weekday, time; shown only when parameter defrost timer = INT	↑, ↓, (Mo-Su etc.) or numbers (hh:mm)	Mo-Su20:15
...			
Defr. 14 xxxxx hh:mm			

 *) Parameter automatically set to ON for safe defrost time at first start.

• Menu 3-2-a Def.Tim.Z2

DEFR.TIMER POS: XXXXX		Entry	Default
Defrost Timer XXX	Setting for how temperature zone 2 should defrost:- MitZ1 Together with zone 1- INT Internally- EXT Externally – the defrost of both temperature zones is started simultaneously via the external signal	↑ ↓ (ViaZ1(ViaZ1,EXT,INT))	ViaZ1
Safe Defr Time XXX m	Safe defrost time, i.e. max. allowed duration of defrosting (internal defrost only)	0..120	60 min
Manual Defrost XXX	Status (ON/OFF) of auxiliary manual defrost *)	↑ ↓ , (ON/OFF)	OFF
Defr. 1 xxxxx hh:mm	Defrost start time for internal defrost; weekday, time of day; shown only when parameter <i>defrost timer</i> = INT	↑ ↓ , (Mo-Su) or numbers (hh:mm)	Mo-Su01:00
...			
Defr. 14 xxxxx hh:mm			

• Menu 3-3 Toggle Setpoints

TOGGLE POS: XXXXX		Entry	Default
Status XXX	Setpoint toggle status (OFF/ON) of alternative set of setpoints (setpoint toggle)		
Toggle Setp. XXX	Setpoint toggle via <ul style="list-style-type: none"> • EXT digital input D21/22 • INT internal timer • CAN bus- „--“ deactivated 	↑ ↓ , (EXT, INT, CAN, --)	EXT
Alt ON: DD-DD hh:mm	Start time for toggle to alternative set of setpoints Weekday from - to XXXXX, time hh:mm Only shown when internal setpoint toggle is activated (Menu 3-3)	↑ ↓ , (Mo-Su etc.) or numbers (hh:mm)	Mo-Su 21:00
Alt OFF: DD-DD hh:mm	End time for toggle to alternative set of setpoints Weekday from - to XXXXX, time hh:mm Only shown when internal setpoint toggle is activated (Menu 3-3)	↑ ↓ , (Mo-Su etc.) or numbers (hh:mm)	Mo-Su 05:00
Alt ON: DD-DD hh:mm	Start time for toggle to alternative set of setpoints Weekday from - to XXXXX, time hh:mm Only shown when internal setpoint toggle is activated (Menu 3-3)	↑ ↓ , (Mo-Su etc.) or numbers (hh:mm)	Su 05:00
Alt OFF: DD-DD hh:mm	End time for toggle to alternative set of setpoints Weekday from - to XXXXX, time hh:mm Only shown when internal setpoint toggle is activated (Menu 3-3)	↑ ↓ , (Mo-Su etc.) or numbers (hh:mm)	Su 21:00
...	A total of 7 different ON and OFF toggle times can be defined. A toggle time will only be obeyed when a <u>matched pair</u> of on and off times is set as a parameter.		

9.4.5 Menu 4 Messages UA 131 / UA 131 LS

MESSAGES POS: XXXXX	
1 View	Move to menu 4-1: Show Message Log
2 Acknowledge	Messages in message log are cancelled. " <i>Alarms Cancelled!</i> " shown in display: Press ESC to go back.
3 Delete	Move to menu 4-2: Delete Message Log (with prompt)

- Menu 4-1 View Messages

MESSAGES POS: XXXXX	
Error Message 1:	Fault 1 message text
dd.mm.yy hh:mm ON	Start of Fault 1
dd.mm.yy hh:mm OFF	End of Fault 1 (only when Fault 1 terminated)
...	
Error Message n:	Fault n message text
dd.mm.yy hh:mm ON	Start of Fault n
dd.mm.yy hh:mm OFF	End of Fault n (only when Fault n terminated)

- Menu 4-2 Acknowledge Messages
This displays the "*Alarms Cancelled!*" message.
- Menu 4-3 Delete Messages

MESSAGES POS: XXXXX		Entry
Delete! Are you sure? No: ESC YES: ↵	Safety prompt for deleting messages Press ESC to go back after cancelling messages.	↵ , ESC

9.4.6 Menu 5 Archive UA 131 / UA 131 LS

ARCHIVE POS: XXXXX	
dd.mm.yy hh:mm	Time of archiving Record 1
Zone 1: abcdef x °C	Status and temperature of Zone 1, see Note
Zone 2: abcdef x °C	Status and temperature of Zone 2, see Note Only shown when two-zone operation is set (Menu 6-1)
...	
dd.mm.yy hh:mm	Time of archiving Record n
Zone 1: abcdef x °C	Status and temperature of Zone 1, see Note
Zone 2: abcdef x °C	Status and temperature of Zone 2, see Note Only shown when two-zone operation is set (Menu 6-1)

 *) Status abcdef covers following states of refrigeration point. The entry at this position is - when a state is not active. Example Zone 1: abcdef x °C

	Single-zone operation resp. Operator interface BT 300	Two-zone operation
a	O = Operation	O = Operation
b	R = Refrigeration / Cooling	R = Refrigeration / Cooling
c	R = Refrigeration/ Cooling	D = Defrost
d	D = Defrost	G = Gate / Door (cold-room controller only)
e	G = Gate / Door (cold-room controller only)	A = Alarm
f	A = Alarm	

9.4.7 Menu 6 Configuration UA 131 / UA 131 LS

CONFIGURAT POS: XXXXX	
1 Refriger. Point	Move to menu 6-1
2 Controller	Move to menu 6-2
3 Cooling	Move to menu 6-3
4 Language	Move to menu 6-4
5 Alarm priorities	Move to menu 6-5
6 Em.Powersupply	Move to menu 6-6
7 Enhanced	Move to menu 6-7

- Menu 6-1 Refriger. Point

REFR. PT. POS: XXXXX		Entry	Default
Refr. Pt. Name:	Text only		
xxxxxxxxxxxxxxxx	Free text entry describing refrigeration point (see note)		Kühlstellenregler
Item ID: XXXXX	Free text entry displayed in screens after ITEM ID (see note)		UA400
Priority: XX	Alarm priority in failure of refrigeration point or when global controller priority is set (Menu 6-5)	↑, ↓, or numbers (0..99)	1
Refr. Sys. No.: XX	No. of pack controller allocated to case/cold-room controller	↑, ↓, or numbers (1..9)	1
Refr. Sys. Type XXX	Associated compressor pack. Parameter only required when linked to a VS 3010 BS having several zones. If a different type of pack controller is used, set this parameter blank (---)	↑, ↓, or numbers (---, Z1, Z2)	—
Temp. Zones X	Number of temperature zones Single-zone operation Two-zone operation	↑, ↓, or numbers (1, 2)	2
No. Sensors XX	Number of temperature sensors connected. After entering ↵ sensor scan is performed to redetermine the number of sensorium of sensors	↵	

⚠ The priority must be assigned between 0..2 by older versions of the store computer (<V5.0), see chapter [Alarms and Messages of UA 400](#).

- ① A meaningful name that describes the refrigeration point in more detail should be entered, e.g. Cheese Counter 2 and CC2. Entry is made in the screens on system centre, store computer or operator terminal. Direct entry cannot be made in the controller screens displayed on the operator terminal. Entry cannot be made either on operator interface BT 300.

- Menu 6-2 Controller

CONTROLLER POS: XXXXX	
1 Type and Version	Move to menu 6-2-1
2 Temp. Display	Move to menu 6-2-2
3 Alarm Delay	Move to menu 6-2-3
4 230V Inputs	Move to menu 6-2-4
5 Sensor Type	Move to menu 6-2-5

- Menu 6-2-1 Type and Version

VERSION POS: XXXXX		Entry	Default
Ctrlr. Type XXXXXXXX	Controller type set by DIP Switch S3	–	UA131
Software Ver.: XXXX	Software version of case/cold-room controller	–	x.yy
Serial No.: XXXXXXX	Device No. of case/cold-room controller	–	
Master/Sl. Mode XXX	Synchronized defrosting in master-slave mode (ON/OFF)	–	

- Menu 6-2-2 Temp. Display

DISPLAY POS: XXXXX		Entry	Default
Offset XX K	Offset for temperature display	-10..10	0K
Alarm symbol X	Show alarm symbol on BT 30 Temperature Display	↑, ↓, (Y/N)	N

- Menu 6-2-3 Alarm Delay

ALARMDELAY POS: XXXXX		Entry	Default
Sensor Fault XX m	Sensor break alarm delay	0..30	15 min
High/Low Temp. XX m	High/low temperature alarm delay	0..120	60 min
No Defrost XX h	No defrost alarm delay	--, 2..168	50 h
Selfholding X	NO: Automatic reset of non- transient alarms. YES: Alarms must be reset manually.	↑, ↓, (Y/N)	N

Eckelmann

- Menu 6-2-4 230V Inputs

 Only trained personnel should be allowed to change inputs, as changes may affect other functions.

230V INPUT POS: XXXXX		Entry	Default
Entry1: XXXXXXXXXXXX	Function of digital input 1 D11/D12	1)	DEFR.TIMER
Entry2: XXXXXXXXXXXX	Function of digital input 2 D21/D22	2)	TOGGLE SETP.
Entry3: XXXXXXXXXXXX	Function of digital input 3 D31/D32	3)	MANUAL OFF.
Entry4: XXXXXXXXXXXX	Function of digital input 4 D41/D42	4)	Extern.Alarm
XXXXXXXXXXXXXXXXXXXX	Freely configurable alarm text for digital input 4, the default text is "CO2-Alarm"	Text	CO2-ALARM
Inv. D1 XXX	Inverting of digital input 1	↑ , ↓ , (ON/OFF)	OFF
Inv. D2 XXX	Inverting of digital input 2		OFF
Inv. D3 XXX	Inverting of digital input 3		OFF
Inv. D4 XXX	Inverting of digital input 4		OFF

Possible settings for the digital inputs:

1. DEFR.TIMER Defrost timer*
 MANUAL OFF. Manual shutoff both zones
 MANUAL OFF. Z1 Manual shutoff only Z1
 MANUAL OFF. Z2 Manual shutoff only Z2
 TOGGLE SETP. Toggle setpoint
2. TOGGLE SETP Toggle setpoint *
 MANUAL OFF Manual shutoff both zones
 MANUAL OFF. Z1 Manual shutoff only Z1
 MANUAL OFF. Z2 Manual shutoff only Z2
3. MANUAL OFF Manual shutoff both zones *
 MANUAL OFF. Z1 Manual shutoff only Z1
 MANUAL OFF. Z2 Manual shutoff only Z2
4. EXT ALARM External Alarm *
 MANUAL OFF Manual shutoff both zones
 MANUAL OFF. Z1 Manual shutoff only Z1
 MANUAL OFF. Z2 Manual shutoff only Z2
 TOGGLE SETP Toggle setpoint

*Factory setting

Eckelmann

- Menu 6-2-5 Sensor Type

Select between values. Checkmark shows current setting.

SENSORS POS: XXXXX		Entry	Default
L243 ✓	Temperature range -50..50°C	↩	✓
K277	Temperature range -50..50°C	↩	
5K3A1	Temperature range 0..100°C	↩	

- Menu 6-3 Cooling

COOLING POS: XXXXX		Entry	Default
Min. On Time XX K	Minimum cooling ON time	0..15	2 m
Min. Off Time XX m	Minimum cooling OFF time	0..15	2 m
Emergency Op. xx m	In failure of required sensors, the solenoid valve is actuated to adjust to the set opening in %.	0..100	100%

S Menu 6-4 Language

LANGUAGE POS: XXXXX	Entry	Default
Deutsch D ✓	↩	✓
English GB	↩	
Francais F	↩	
Espagnol E	↩	
Finnish FIN	↩	
Türkce TR	↩	
Cesky CZ	↩	

- Menu 6-5 Alarm priorities

ALARMPRIOS POS: XXXXX		Entry	Default
Prio.Refrig. Pt. X	Global alarm priority by refrigeration point priority (Menu 6-1) (Y)	↑, ↓, (Y,N)	N
Priority: XX	Show refrigeration point priority (Menu 6-1) Only shown when refrigeration point priority set to Y.		2
<i>Following parameters are only shown when refrigeration point priority is set to N. Meaning of usable entries for alarm priority:-= Event ignored 0=Message (entered only in message log) 1=Priority 1 alarm..99=Priority 99 alarm</i>			
Low Temp.	Temperature below lower alarm limit Priority applies to following alarms: Low Temp. Zone1, Low Temp. Zone2	-, 0..99	2
High Temp.	Temperature above upper alarm limit Priority applies to following alarms: High Temp. Zone1, High Temp. Zone2	-, 0..99	1
Sensor Fault	Temperature sensor failure	-, 0..99	2
No Defrost	No defrost within alarm delay interval Priority applies to following alarm: No defrost	-, 0..99	2
Timer-Term.Defr.	Defrosting terminated by safe defrost time	-, 0..99	0
Power Failure	Start following power failure	-, 0..99	0
First Start	Controller start up (basic settings loaded!)	-, 0..99	2
Manual Shutoff	Manual switch Input D31/D32 set OFF	-, 0..99	0
Hardware Fault	Internal hardware fault Priority applies to following alarms: EEPROM Fault, RTC Fault, Flash Fault	-, 0..99	1
Setpoint Change	Message generated on changing setpoint	0..99	0
Refrig.Pt.Dis.	Cooling by pack controller via CAN bus interrupted	-, 0..99	0
Battery Voltage	Battery low	-, 0..99	0

- Menu 6-6 Em.Powersupply (Emergency Power supply)

EM.POW.SUP POS: XXXXX		Entry	Default
Cool.funct.OFF xxx	Functionality of the cooling switched off during emergency power supply? (Y/N)	↑ , ↓ , (Y/N)	N
Defr.funct.OFF xxx	Functionality of the defrosting switched off during emergency power supply? (Y/N)	↑ , ↓ , (Y/N)	N
Fan funct. OFF xxx	Functionality of the fan switched off during emergency power supply? (Y/N)	↑ , ↓ , (Y/N)	N
Frame fct.OFF xxx	Functionality of the frame heater off during emergency power supply? (Y/N)	↑ , ↓ , (Y/N)	N
Light fct. OFF xxx	Functionality of the light during emergency power supply? (Y/N)	↑ , ↓ , (Y/N)	N

- Menu 6-7 Enhanced

ENHANCED POS: XXXXX	
1 SDS TEV	Move to menu 6-7-1
2 Service Mode	Move to menu 6-7-2

- Menu 6-7-1 SDS TEV

SDS TEV POS: XXXXX		Entry	Default
SDS TEV xx m	Principle participation of the controller in the suction pressure shift. (function COPT+). Note: This is transmitted via a CAN bus telegram and intervenes in the regulation!	↑ , ↓ , (ON/OFF)	OFF
Inact.a.Def xx m	Delay time following completion of the defrost before the controller actively intervenes in the shift.	0..40	30 min,
Dely_HystON xxxxm	Delay time for the reduction request with active cooling and overshoot of the hysteresis.	0..10	2.5 min
HiTmpZ1 dwn xxm	Delay time before the elapse of the high temperature alarm delay in zone 1, before the reduction is requested.	0..15	5 min.
HiTmpZ2 dwn xxm	Delay time before the elapse of the high temperature alarm delay in zone 2, before the reduction is requested.	0..15	5 min.
TolOvHystZ1 xxK	Tolerance limit above the setpoint plus hysteresis in zone 1. Influences when it is switched from stop to reduce.	0..20	2 K
TolOvHystZ2 xxK	Tolerance limit above the setpoint plus hysteresis in zone 2. Influences when it is switched from stop to reduce.	0..20	2 K
SwchSupRet xxx	Switching from supply air to return air and the reverse with temperature alarm delay time.	↑ , ↓ , (ON/OFF)	OFF
Dely_Switch xxxm	Switching from supply to return air: determines when it is switched within the delay time for the high temperature alarm.	0..15	5 min.
Add.Values xxx	Creation of additional (additive) "Debug" actual value archives in the system centre / store computer. Warning: This can force a reorganisation of the actual value archives – for this reason only use when required!	↑ , ↓ , (ON/OFF)	OFF
Incl_UpLim xxxK	Upper limit of the neutral zone for determining the incline.	0..5	0.3 K
Incl_LwLim xxxK	Lower limit of the neutral zone for determining the incline.	0..5	0.2 K

- Menu 6-7-2 Service Mode

SERVICIE MOD POS: XXXXX		Entry	Default
Relay 1 x	Relay 1 (terminal 15/16/18) switch on or off (1 or 0)	0 / 1	0
Relay 2 x	Relay 2 (terminal 25/26/28) switch on or off (1 or 0)	0 / 1	0
Relay 3 x	Relay 3 (terminal 35/36/38) switch on or off (1 or 0)	0 / 1	0
Relay 4 x	Relay 4 (terminal 43/44) switch on or off (1 or 0)	0 / 1	0
Relay 5 x	Relay 5 (terminal 53/54) switch on or off (1 or 0)	0 / 1	0
Relay 6 x	Relay 6 (terminal 64/65) switch on or off (1 or 0)	0 / 1	0
Relay 7 x	Relay 7 (terminal 73/74) switch on or off (1 or 0)	0 / 1	0
24V Out 1 x	Transistor output 1 (terminal 81/82) switch on or off (24 VDC / 50 mA)	0 / 1	0
24V Out 2 x	Transistor output 2 (terminal 91/92) switch on or off (24 VDC / 50 mA)	0 / 1	0
ANA OUT 1 xxxV	Analog output 1 (terminal 29/30) Default 0..10 VDC	0..10	0.0V
ANA OUT 2 xxxV	Analog output 2 (terminal 31/32) Default 0..10 VDC	0..10	0.0V
ANA IN 1 xxmA	Power analog input 1 (terminal 11/12) 4..20 mA	4..20	mA
ANA IN 2 xxmA	Power analog input 2 (terminal 11/14) 4..20 mA	4..20	mA
InputD 1 xxx	Status digital input 1 ON = 230 V AC voltage connected OFF = no voltage present	ON/OFF	-
InputD 2 xxx	Status digital input 2 ON = 230 V AC voltage connected OFF = no voltage present	ON/OFF	-
InputD 3 xxx	Status digital input 3 ON = 230 V AC voltage connected OFF = no voltage present	ON/OFF	-
InputD 4 xxx	Status digital input 4 ON = 230 V AC voltage connected OFF = no voltage present	ON/OFF	-

9.5 Controller type UA 131 DD - menu tree

DIP switch S3	UA 131 DD
	1: ON 2: ON 3: ON 4: OFF 8: OFF 9: ON

Main menu	Submenu	Submenu 2	Menu number	Menu name
			0	REFRIGERATION POINT
Actual values			1	ACTUAL VALUES
	Temperature sensor		1-1	TEMPERATURE
	Cooling Zone 1		1-2	COOLING 1
	Defrost Zone 1		1-3	DEFROST 1
	Condenser Fans		1-4	FAN 1
	Alarm		1-5	ALARM
	Frame heater		1-6	FRAME HEATER
	Cooling Zone 2		1-7	COOLING 2
	Defrost Zone 2		1-8	DEFROST 2
Setpoints			2	SETPOINTS
	Cooling		2-1	COOLING
		Zone 1	2-1-1	COOLING 1
		Zone 2	2-1-2	COOLING 2
		Zone 1 U Umschalt.	2-1-3	COOLING 1U
		Zone 2 U Umschalt.	2-1-4	COOLING 2U
	Defrost		2-2	DEFROST
		Zone 1	2-2-1	DEFROST 1
		Zone 2	2-2-2	DEFROST 2
		Zone 1 U Umschalt.	2-2-3	DEFROST 1U
		Zone 2 U Umschalt.	2-2-4	DEFROST 2U
	-			
	Alarm		2-4	ALARM

		Zone 1	2-4-1	ALARM 1
		Zone 2	2-4-2	ALARM 2
		Zone 1 U Umschalt.	2-4-3	ALARM 1U
		Zone 2 U Umschalt.	2-4-4	ALARM 2U
	Frame heater		2-5	RAHMENHEIZ
		Frame heater mode	2-5-1	FRAME HEATER
		Frame heater setpoints	2-5-2	SETPOINTS
		Toggle mode	2-5-3	RAHMEN UM.
		Toggle setpoints	2-5-4	SOLLW. UM.
	Discharge gas defrosting		2-6	HOTGAS
		Zone 1+2	2-6-1	HOTGAS
		Zone 1+2 Umschalt	2-6-2	DRUCKGAS U
Clock			3	CLOCK
	current time		3-1	CLOCK
	Defrost timer		3-2	DEFROST TIMER
	Toggle setpoints		3-3	UMSCHALTNG
Messages			4	MESSAGES
	view		4-1	MESSAGES
	acknowledge		4-2	
	delete		4-3	MESSAGES
Archive			5	ARCHIVE
Configuration			6	KONFIGURAT
	Refrigeration point		6-1	REFRIGERATION POINT
	Controller		6-2	CONTROLLER
		Type and version	6-2-1	VERSION
		Temperature display	6-2-2	DISPLAY
		Alarm delay	6-2-3	ALARMVERZ.
		230 V inputs	6-2-4	230 V INPUTS
		Sensor type	6-2-5	SENSOR TYPE

Cooling		6-3	COOLING
Language		6-4	LANGUAGE
Alarm priorities		6-5	ALARMPRIOS
Emergency power operation		6-6	NOTNETZ
Advanced		6-7	ADVANCED
	SDS TEV	6-7-1	SDS TEV
	Service Mode	6-7-2	SERVICE MOD

9.5.1 Main menu UA 131 DD

REFR. PT. POS: XXXXX	
1 Actual Values	Move to menu 1
2 Setpoints	Move to menu 2
3 Clock	Move to menu 3
4 Messages	Move to menu 4
5 Archive	Move to menu 5
6 Configuration	Move to menu 6

9.5.2 Menu 1 Actual Values UA 131 DD

ACT VALUES POS: XXXXX	
1 Temp. Sensor	Move to menu 1-1
2 Cooling Zone 1	Move to menu 1-2
3 Defrost Zone 1	Move to menu 1-3
4 Evap. fan	Move to menu 1-4
5 Alarm	Move to menu 1-5
6 Frame Heater	Move to menu 1-6
7 Cooling Zone 2	Move to menu 1-7 Only shown when two-zone operation is set (Menu 6-1)
8 Defrost Zone 2	Move to menu 1-8 Only shown when two-zone operation is set (Menu 6-1)

- Menu 1-1 Temp. Sensor

TEMPERATUR Pos: XXXXX	
Temp. R2.1 xxx °C	Current supply air temperature Input Z11/ Z12
Temp. R4.1 xxx °C	Current return air temperature Input Z21/ Z22
Temp. R1.1 xxx °C	Current evaporator defrost termination temperature Input Z31/ Z32
Temp. R4.2 xxx °C	Current return air temperature Input Z41/ Z42
Temp. R1.2 xxx °C	Current evaporator defrost termination temperature Input Z51/ Z52
Temp. R2.3 xxx °C	Current supply air temperature Input Z61/ Z62
Temp. R4.3 xxx °C	Current return air temperature Input Z71/ Z72
Temp. R1.3 xxx °C	Current evaporator defrost termination temperature Input Z81/ Z82
Temp. R4.4 xxx °C	Current return air temperature Input Z91/ Z92
Temp. R1.4 xxx °C	Current evaporator defrost termination temperature Input Z01/ Z02

- Menu 1-2 Cooling Zone 1

COOLING 1 Pos: XXXXX	
Cooling xxx	Current ON/OFF status of cooling
Run Time xx %	Cooling relay on time during last day (00:00 - 24:00 hours)
Starts 0	Cooling relay actuations during last day
Temp. R2.1 xxx °C	Current supply air temperature Input Z11/Z12
Setpoint R2.1 xxx °C	Supply air temperature setpoint for comparison
Hysteresis R2.1 xxx K	Supply air temperature hysteresis setpoint
Temp. R4.1 xxx °C	Current return air temperature Input Z21/Z22
Setpoint R4.1 xxx °C	Return air temperature setpoint for comparison
Hysteresis R4.1 xxx K	Return air temperature hysteresis setpoint

- Menu 1-3 Defrost Zone 1

DEFROST 1 Pos: XXXXX	
Defr. Relay 1	Defrost Relay 1
Temp. R1.1 XXX °C	Current supply air temperature Input Z31/Z32
Defr. Relay 2	Defrost Relay 2
Temp. R1.2 XXX °C	Current supply air temperature Input Z51/Z52
Def. End. Tmp. XXX °C	Defrost termination temperature for comparison
Last DefrSt XX hh:mm	Day and time of last defrost cycle started
M/S Nof. Sl.	Number of parameterised and accessible MA slaves
M/S Lost Sl.	CAN address of the first MA slave which was not accessible during the last defrost
M/S Defr.Sl.	Number of slaves currently undergoing a defrost
M/S DSIMat	List of MA slaves currently undergoing a defrost (can be scrolled through using ENTER)
DSq Nof. Sl.	Number of DS slaves (only in the case of DS master)
DSq Lost Sl.	CAN address of the first FA slave which was not accessible during the last defrost
DSq Defr.Sl.	Number of slaves currently undergoing defrost
DSq DSIMat	List of FA slaves currently undergoing a defrost (can be scrolled through using ENTER)

- Menu 1-4 Evap. fan

FANS 1 Pos: XXXXX	
FANS	Fan ON/OFF
Temp. R1.1 XXX °C	Current supply air temperature Input Z31/Z32
Temp. R1.3 XXX °C	Current supply air temperature Input Z81/Z82
Fans Start XXX °C	Fan start

- Menu 1-5 Alarm

ALARM Pos: XXXXX	
Alarm XXX	Current OFF/ON status of alarm
Hi Temp Setp.1 XX °C	High temperature setpoint Zone 1
Lo Temp Setp.1 XX K	Low temperature setpoint Zone 1
Hi Temp Setp.2 XX °C	High temperature setpoint Zone 2; Only shown when two-zone operation is set (Menu 6-1)
Lo Temp Setp.2 XX K	Low temperature setpoint Zone 2; Only shown when two-zone operation is set (Menu 6-1)

- Menu 1-6 Frame Heater

MODE XXXXX	
Frame Heater xxx	Current ON/OFF status of frame heater output Terminal 91/92/93
Run Time xxx %	Current on time of frame heater
Humidity xxx %	Current ambient air humidity (transmitted via CAN bus from pack controller with fitted ambient humidity sensor)
Room temp xx °C	Current ambient air temperature (transmitted via CAN bus from pack controller with fitted ambient temperature sensor)

- Menu 1-7 Cooling Zone 2

COOLING 2 XXXXX	
Cooling XXX	Current ON/OFF status of cooling
Run Time XX %	Cooling relay on time during last day (00:00 - 24:00 hours)
Starts 0	Cooling relay actuations during last day
Temp. R2.3 XXX °C	Current supply air temperature Input Z61/Z62
Setpoint R2.3 XXX °C	Supply air temperature setpoint for comparison
Hysteresis R2.3 XXX K	Supply air temperature hysteresis setpoint
Temp. R4.3 XXX °C	Current return air temperature Input Z71/Z72
Setpoint R4.3 XXX °C	Return air temperature setpoint for comparison
Hysteresis R4.3 XXX K	Return air temperature hysteresis setpoint

- Menu 1-8 Defrost Zone 2

DEFROST 2 Pos: XXXXX	
Defr. Relay 3	Defrost Relay 3
Temp. R1.3 XXX °C	Current supply air temperature Input Z81/Z82

Eckelmann

DEFROST 2 Pos: XXXXX	
Defr. Relay 4	Defrost Relay 4
Temp. R1.4 XXX °C	Current supply air temperature Input Z01/Z02
Def. End. Tmp. XXX °C	Defrost termination temperature for comparison
Last Defrst XX hh:mm	Day and time of last defrost cycle started

9.5.3 Menu 2 Setpoints UA 131 DD

SETPOINTS POS: XXXXX	
1 Cooling	Menu 2-1; Special case: Move to menu 2-1-1 when single-zone operation is set (Menu 6-1) and setpoint toggle is disabled (Menu 3-3).
2 Defrost	Menu 2-2; Special case: Move to menu 2-2-1 when single-zone operation is set (Menu 6-1) and setpoint toggle is disabled (Menu 3-3).
3	Not used with this controller type
4 Alarm	Menu 2-4; Special case: Move to menu 2-4-1 when single-zone operation is set (Menu 6-1) and setpoint toggle is disabled (Menu 3-3).
5 Frame Heater	Move to menu 2-5
6 Hot gas Defrost	Move to menu 2-6; Special case: Only shown when setpoint toggle is disabled (Menu 3-3)

- Menu 2-1 Cooling

COOLING POS: XXXXX	
1 Zone 1	Menu 2-1-1
2 Zone 2	Menu 2-1-2 Only shown when two-zone operation is set (Menu 6-1)
3 Zone 1A Altern.	Menu 2-1-3 Not shown when setpoint toggle is disabled (Menu 3-3)
4 Zone 2A Altern.	Menu 2-1-4 Only shown when two-zone operation is set (Menu 6-1) and setpoint toggle is not disabled (Menu 3-3)

- Menu 2-1-1 Zone 1

COOLING 1 POS: XXXXX		Entry	Default
Setpoint R2.1 XXX °C	Supply air temperature setpoint	-40..30	-32 °C
Hysteresis R2.1 X K	Supply air temperature hysteresis setpoint	1..8	2 K
Setpoint R4.1 XXX °C	Return air temperature setpoint for comparison	-30..30	-20 °C
Hysteresis R4.1 X K	Return air temperature hysteresis setpoint	1..8	2 K

- Menu 2-1-2 Zone 2

COOLING 2 POS: XXXXX		Entry	Default
Setpoint R2.3 XXX °C	Supply air temperature setpoint	-40..30	-32 °C
Hysteresis R2.3 X K	Supply air temperature hysteresis setpoint	1..8	2 K
Setpoint R4.3 XXX °C	Return air temperature setpoint for comparison	-30..30	-20 °C
Hysteresis R4.3 X K	Return air temperature hysteresis setpoint	1..8	2 K

- Menu 2-1-3 Zone 1A Altern.

COOLING 1A POS: XXXXX		Entry	Default
Setpoint R2.1 XXX °C	Supply air temperature setpoint	-40..30	-32 °C
Hystersis R2.1 X K	Supply air temperature hysteresis setpoint	1..8	2 K
Setpoint R4.1 XXX °C	Return air temperature setpoint for comparison	-30..30	-22 °C
Hystersis R4.1 X K	Return air temperature hysteresis setpoint	1..8	2 K

- Menu 2-1-4 Zone 2A Altern.

COOLING 2A POS: XXXXX		Entry	Default
Setpoint R2.3 XXX °C	Supply air temperature setpoint	-40..30	-32 °C
Hystersis R2.3 X K	Supply air temperature hysteresis setpoint	1..8	2 K
Setpoint R4.3 XXX °C	Return air temperature setpoint for comparison	-30..30	-22 °C
Hystersis R4.3 X K	Return air temperature hysteresis setpoint	1..8	2 K

- Menu 2-2 Defrost

DEFROST POS: XXXXX	
1 Zone 1	Menu 2-2-1
2 Zone 2	Menu 2-2-2 Only shown when two-zone operation is set (Menu 6-1)
3 Zone 1A Altern.	Menu 2-2-3 Not shown when setpoint toggle is disabled (Menu 3-3)
4 Zone 2A Altern.	Menu 2-2-4 Only shown when two-zone operation is set (Menu 6-1) and setpoint toggle is not disabled (Menu 3-3)

- Menu 2-2-1 Zone 1

DEFROST 1 POS: XXXXX		Entry	Default
Def. End. Tmp. XX °C	Defrost termination temperature setpoint	0..30	10 °C
Drip Time x m	Waiting time (drain time) setpoint between defrosting and cooling	0 .. 15	0 m
M/S Degiv.Fct. XXX	Configuration of the defrost via CAN bus function. For details see chapter Master-Slave-Modus - Abtau-Synchronisation über CAN-Bus .	OFF, MASTR, SLAVE	OFF
M/S CAN Adr. XXX	Selection of the controller (1..99) participating in the defrost via CAN bus which is the master. "-", if this controller is itself master (Parameter <i>M/S Degiv.Fct.</i> = MASTR)	---, 1..99	-
DS-Function XXX	Configuration of the defrost sequence function (DS). For details see chapter Folgeabtauung (FA) über CAN-Bus .	OFF, MASTR, SLAVE	OFF

Eckelmann

DEFROST 1 POS: XXXXX		Entry	Default
DS-Group XXX	Selection of which group a defrost sequence of this controller (1..99) belongs to.	---, 1..99	–
DS-Master XXX	Selection of which controller (1..99) participating in the defrost sequence is the master. "--", if this controller is itself the master(Parameter <i>DS-Function</i> = MASTR)	---, 1..99	–
DS-Wait time XXXm	Wait time for the defrost sequence	0..127	1 min

- Menu 2-2-2 Zone 2

DEFROST 2 POS: XXXXX		Entry	Default
Def. End. Temp. XX °C	Defrost termination temperature setpoint	--, 0..30	10 °C
Drip Time x m	Waiting time (drain time) setpoint between defrosting and cooling	0 .. 15	0 m

- Menu 2-2-3 Zone 1A Altern.

DEFROST 1A POS: XXXXX		Entry	Default
Def. End. Temp. XX °C	Defrost termination temperature setpoint	0..30	10 °C
Drip Time x m	Waiting time (drain time) setpoint between defrosting and cooling	0 .. 15	0 m

- Menu 2-2-4 Zone 2A Altern.

DEFROST 2A POS: XXXXX		Entry	Default
Def. End. Temp. XX °C	Defrost termination temperature setpoint	--, 0..30	10 °C
Drip Time x m	Waiting time (drain time) setpoint between defrosting and cooling	0 .. 15	0 m

- Menu 2-3

Not used with this controller type.

- Menu 2-4 Alarm

ALARM POS: XXXXX	
1 Zone 1	Menu 2-4-1
2 Zone 2	Menu 2-4-2 Only shown when two-zone operation is set (Menu 6-1)
3 Zone 1A Altern.	Menu 2-4-3 Not shown when setpoint toggle is disabled (Menu 3-3)
4 Zone 2A Altern.	Menu 2-4-4 Only shown when two-zone operation is set (Menu 6-1) and setpoint toggle is not disabled (Menu 3-3)

- Menu 2-4-1 Zone 1

ALARM 1 POS: XXXXX		Entry	Default
High Temp Setp XX °C	High temperature setpoint at which <i>High Temperature</i> alarm is generated	-30..30	-12 °C
Low Temp Setp. XX K	Low temperature setpoint (difference below temperature control setpoint) at which <i>Low Temperature</i> alarm is generated	--, 0..6	4 K

- Menu 2-4-2 Zone 2

ALARM 2 POS: XXXXX		Entry	Default
High Temp Setp XX °C	High temperature setpoint at which <i>High Temperature</i> alarm is generated	-30..30	-12 °C
Low Temp Setp. XX K	Low temperature setpoint (difference below temperature control setpoint) at which <i>Low Temperature</i> alarm is generated	--, 0..6	4 K

- Menu 2-4-3 Zone 1A Altern.

ALARM 1A POS: XXXXX		Entry	Default
High Temp Setp XX °C	High temperature setpoint at which <i>High Temperature</i> alarm is generated	-30..30	-14 °C
Low Temp Setp. XX K	Low temperature setpoint (difference below temperature control setpoint) at which <i>Low Temperature</i> alarm is generated	--, 0..6	4 K

- Menu 2-4-4 Zone 2A Altern.

ALARM 2A POS: XXXXX		Entry	Default
High Temp Setp XX °C	High temperature setpoint at which <i>High Temperature</i> alarm is generated	-30..30	-14 °C
Low Temp Setp. XX K	Low temperature setpoint (difference below temperature control setpoint) at which <i>Low Temperature</i> alarm is generated	--, 0..6	4 K

- Menu 2-5 Frame Heater

FRAME HTR POS: XXXXX		
1 Mode altern.	Move to menu 2-5-1	
2 Setpoint frm htr	Move to menu 2-5-2	
3 Mode altern.	Move to menu 2-5-3 Not shown when setpoint toggle is disabled (Menu 3-3)	
4 Setpoint altern.	Move to menu 2-5-4 Not shown when setpoint toggle is disabled (Menu 3-3)	

- Menu 2-5-1 Mode altern.

Select between values. Checkmark shows current setting.

MODE POS: XXXXX		Entry	Default
fixed run time ✓	Fixed frame heater on time	↵	✓
enthalpy-ctrl rtm	Enthalpy control by ambient air temperature and humidity	↵	

- Menu 2-5-2 Setpoint frame heater

SETPOINTS POS: XXXXX		Entry	Default
Mod: xxxxxxxxxxxxx	Displays set frame heater mode (Menu 2-5-1)		Fixed on time
Run Time XXX %	Fixed on time, Only shown when mode set to Fixed On Time (Menu 2-5-1)	--, 0..100	100 %
emerg.run time XXX %	On time in failure of ambient air humidity or temperature signal (via CAN bus) Only shown when mode set to Enthalpy Control (Menu 2-5-1)	--, 0..100	100 %
enthalp. offs. XXX %	Offset to on time with activated enthalpy control (via CAN bus) Only shown when mode set to Enthalpy Control (Menu 2-5-1)	-50..50	0 %
Invert Output xxx	Inversion of the function of the frame heater output (terminal 91/92)	↑ , ↓ , (ON/OFF)	ON

- Menu 2-5-3 Mode altern.

Select between values. Checkmark shows current setting.

MODE ALT POS: XXXXX		Entry	Default
fixed run time ✓	Fixed frame heater on time	←	✓
enthalpy-ctrl rtm	Enthalpy control by ambient air temperature and humidity	←	

- Menu 2-5-4 Setpoint altern.

SOLLW. UM POS: XXXXX		Entry	Default
Mod: xxxxxxxxxxxxx	Displays set frame heater mode (Menu 2-5-3)		Fixed on time
Run Time XXX %	Fixed on time, Only shown when mode set to Fixed On Time (Menu 2-5-3)	--, 0..100	100 %
emerg.run time XXX %	On time in failure of ambient air humidity or temperature signal (via CAN bus) Only shown when mode set to Enthalpy Control (Menu 2-5-3)	--, 0..100	100 %
enthalp. offs. XXX %	Offset to on time with activated enthalpy control (via CAN bus) Only shown when mode set to Enthalpy Control (Menu 2-5-3)	-50..50	0 %

- Menu 2-6 hot gas

HOTGAS POS: XXXXX		Entry
1 Zone 1+2	Move to menu 2-6-1	1
2 Zone 1+2 Altern.	Move to menu 2-6-2 Not shown when setpoint toggle is disabled (Menu 3-3)	2

Eckelmann

- Menu 2-6-1 hot gas

HOTGAS POS: XXXXX		Entry	Default
Fans Start	Fan start setpoint	--, -20 .. 20	-5 °C
Flooding Evap.	Evaporator flood duration	0..15	3 m

- Menu 2-6-1 Hot gas U

HOTGAS A POS: XXXXX		Entry	Default
Fans Start	Fan start setpoint	--, -20 .. 20	-5 °C
Flooding Evap.	Evaporator flood duration	0..15	3 m

9.5.4 Menu 3 Clock UA 131 DD

CLOCK POS: XXXXX	
1 Current Time	Move to menu 3-1
2 Defrost timer	Move to menu 3-2
3 Toggle Setpoints	Move to menu 3-3

- Menu 3-1 Current Time

 Time is defined by time master (system centre / store computer / operator terminal) when CAN bus is connected. Any entry made will then be overwritten by the defined value.

CLOCK POS: XXXXX		Entry	Default
Date: XX dd.mm.yy	Display and enter current weekday, date	dd.mm.yy	
Time: hh.mm	Display and enter current time	hh.mm	
Daylight Saving X	Display and enter automatic daylight saving change (Y/N)	↑ ↓ , (Y/N)	J

- Menu 3-2 Defrost timer

DERF. TIMER POS: XXXXX		Entry	Default
Defrost timer XXX	Type of defrost initiation. NO internal defrost initiation due to discharge gas controller characteristics (defrosting always initiated by VS pack controller via CAN bus)	–	EXT

Eckelmann

• Menu 3-3 Toggle Setpoints

TOGGLE POS: XXXXX		Entry	Default
Status XXX	Setpoint toggle status (OFF/ON) of alternative set of setpoints (setpoint toggle)		
Toggle Setp. XXX	Setpoint toggle via <ul style="list-style-type: none"> • EXT digital input D21/22 • INT internal timer • CAN bus- „-“ deactivated 	↑ , ↓ , (EXT, INT, CAN, --)	EXT
Blind On Time x s	Fan and cooling stop time after toggling to alternative set of setpoints with external setpoint toggle (Menu 3-3)	0..250	0 s
Alt ON: DD-DD hh:mm	Start time for toggle to alternative set of setpoints Weekday from - to XXXXX, time hh:mm Only shown when internal setpoint toggle is activated (Menu 3-3)	↑ , ↓ , (Mo-Su etc.) or numbers (hh:mm)	Mo-Su 21:00
Alt OFF: DD-DD hh:mm	End time for toggle to alternative set of setpoints Weekday from - to XXXXX, time hh:mm Only shown when internal setpoint toggle is activated (Menu 3-3)	↑ , ↓ , (Mo-Su etc.) or numbers (hh:mm)	Mo-Su 05:00
Alt ON: DD-DD hh:mm	Start time for toggle to alternative set of setpoints Weekday from - to XXXXX, time hh:mm Only shown when internal setpoint toggle is activated (Menu 3-3)	↑ , ↓ , (Mo-Su etc.) or numbers (hh:mm)	Su 05:00
Alt OFF: DD-DD hh:mm	End time for toggle to alternative set of setpoints Weekday from - to XXXXX, time hh:mm Only shown when internal setpoint toggle is activated (Menu 3-3)	↑ , ↓ , (Mo-Su etc.) or numbers (hh:mm)	Su 21:00
...	A total of 7 different ON and OFF toggle times can be defined. A toggle time will only be obeyed when a <u>matched pair</u> of on and off times is set as a parameter.		

9.5.5 Menu 4 Messages UA 131 DD

MESSAGES POS: XXXXX	
1 View	Move to menu 4-1: Show Message Log
2 Acknowledge	Messages in message log are cancelled. <i>"Alarms Cancelled!"</i> shown in display: Press ESC to go back.
3 Delete	Move to menu 4-2: Delete Message Log (with prompt)

- Menu 4-1 View Messages

MESSAGES POS: XXXXX	
Error Message 1:	Fault 1 message text
dd.mm.yy hh:mm ON	Start of Fault 1
dd.mm.yy hh:mm OFF	End of Fault 1 (only when Fault 1 terminated)
...	
Error Message n:	Fault n message text
dd.mm.yy hh:mm ON	Start of Fault n
dd.mm.yy hh:mm OFF	End of Fault n (only when Fault n terminated)

- Menu 4-2 Acknowledge Messages
This displays the *"Alarms Cancelled!"* message.
- Menu 4-3 Delete Messages

MESSAGES POS: XXXXX		Entry
Delete! Are you sure? No: ESC YES: ↵	Safety prompt for deleting messages Press ESC to go back after cancelling messages.	↵ , ESC

9.5.6 Menu 5 Archive UA 131 DD

ARCHIVE POS: XXXXX	
dd.mm.yy hh:mm	Time of archiving Record 1
Zone 1: abcdef x °C	Status and temperature of Zone 1, see Note
Zone 2: abcdef x °C	Status and temperature of Zone 2, see Note Only shown when two-zone operation is set (Menu 6-1)
...	
dd.mm.yy hh:mm	Time of archiving Record n
Zone 1: abcdef x °C	Status and temperature of Zone 1, see Note
Zone 2: abcdef x °C	Status and temperature of Zone 2, see Note Only shown when two-zone operation is set (Menu 6-1)

 *) Status abcdef covers following states of refrigeration point. The entry at this position is - when a state is not active. Example Zone 1: abcdef x °C

	Single-zone operation resp. Operator interface BT 300	Two-zone operation
a	O = Operation	O = Operation
b	R = Refrigeration / Cooling	R = Refrigeration / Cooling
c	R = Refrigeration/ Cooling	D = Defrost
d	D = Defrost	G = Gate / Door (cold-room controller only)
e	G = Gate / Door (cold-room controller only)	A = Alarm
f	A = Alarm	

9.5.7 Menu 6 Configuration UA 131 DD

CONFIGURAT POS: XXXXX	
1 Refriger. Point	Move to menu 6-1
2 Controller	Move to menu 6-2
3 Cooling	Move to menu 6-3
4 Language	Move to menu 6-4
5 Alarm priorities	Move to menu 6-5
6 Em.Powersupply	Move to menu 6-6
7 Enhanced	Move to menu 6-7

- Menu 6-1 Refriger. Point

REFR. PT. POS: XXXXX		Entry	Default
Refr. Pt. Name:	Text only		
xxxxxxxxxxxxxxxx	Free text entry describing refrigeration point (see note)		Kühlstellenregler
Item ID: XXXXX	Free text entry displayed in screens after ITEM ID (see note)		UA400
Priority: XX	Alarm priority in failure of refrigeration point or when global controller priority is set (Menu 6-5)	↑, ↓, or numbers (0..99)	1
Refr. Sys. No.: XX	No. of pack controller allocated to case/cold-room controller	↑, ↓, or numbers (1..9)	1
Refr. Sys. Type XXX	Associated compressor pack. Parameter only required when linked to a VS 3010 BS having several zones. If a different type of pack controller is used, set this parameter blank (---)	↑, ↓, or numbers (---, Z1, Z2)	—
Temp. Zones X	Number of temperature zones Single-zone operation Two-zone operation	↑, ↓, or numbers (1, 2)	2
No. Sensors XX	Number of temperature sensors connected. After entering ↵ sensor scan is performed to redetermine the number of sensorium of sensors	↵	

⚠ The priority must be assigned between 0..2 by older versions of the store computer (<V5.0), see chapter [Alarms and Messages of UA 400](#).

- ① A meaningful name that describes the refrigeration point in more detail should be entered, e.g. Cheese Counter 2 and CC2. Entry is made in the screens on system centre, store computer or operator terminal. Direct entry cannot be made in the controller screens displayed on the operator terminal. Entry cannot be made either on operator interface BT 300.

- Menu 6-2 Controller

CONTROLLER POS: XXXXX	
1 Type and Version	Move to menu 6-2-1
2 Temp. Display	Move to menu 6-2-2
3 Alarm Delay	Move to menu 6-2-3
4 230V Inputs	Move to menu 6-2-4
5 Sensor Type	Move to menu 6-2-5

- Menu 6-2-1 Type and Version

VERSION POS: XXXXX		Entry	Default
Ctrlr. Type XXXXXXXX	Controller type set by DIP Switch S3	–	UA131DD
Software Ver.: XXXX	Software version of case/cold-room controller	–	x.yy
Serial No.: XXXXXXX	Device No. of case/cold-room controller	–	
Master/Sl. Mode XXX	Synchronized defrosting in master-slave mode (ON/OFF)	–	

- Menu 6-2-2 Temp. Display

DISPLAY POS: XXXXX		Entry	Default
Offset XX K	Offset for temperature display	-10..10	0K
Alarm symbol X	Show alarm symbol on BT 30 Temperature Display	↑, ↓, (Y/N)	N

- Menu 6-2-3 Alarm Delay

ALARMDELAY POS: XXXXX		Entry	Default
Sensor Fault XX m	Sensor break alarm delay	0..30	15 min
High/Low Temp. XX m	High/low temperature alarm delay	0..150	60 min
No Defrost XX h	No defrost alarm delay	--, 2..168	50 h
Selfholding X	NO: Automatic reset of non- transient alarms. YES: Alarms must be reset manually.	↑, ↓, (Y/N)	N

- Menu 6-2-4 230V Inputs

 Only trained personnel should be allowed to change inputs, as changes may affect other functions.

230V INPUT POS: XXXXX		Entry	Default
Entry1: XXXXXXXXXXXX	Function of digital input 1 D11/D12	1)	DEFR.TIMER
Entry2: XXXXXXXXXXXX	Function of digital input 2 D21/D22	2)	TOGGLE SETP.
Entry3: XXXXXXXXXXXX	Function of digital input 3 D31/D32	3)	MANUAL OFF.
Entry4: XXXXXXXXXXXX	Function of digital input 4 D41/D42	4)	Extern.Alarm
XXXXXXXXXXXXXXXXXXXX	Freely configurable alarm text for digital input 4, the default text is "CO2-Alarm"	Text	CO2-ALARM
Inv. D1 XXX	Inverting of digital input 1	↑, ↓, (ON/OFF)	OFF
Inv. D2 XXX	Inverting of digital input 2		OFF
Inv. D3 XXX	Inverting of digital input 3		OFF
Inv. D4 XXX	Inverting of digital input 4		OFF

Possible settings for the digital inputs:

1. DEFR.TIMER Defrost timer*
 MANUAL OFF. Manual shutoff both zones
 MANUAL OFF. Z1 Manual shutoff only Z1
 MANUAL OFF. Z2 Manual shutoff only Z2
 TOGGLE SETP. Toggle setpoint
2. TOGGLE SETP Toggle setpoint *
 MANUAL OFF Manual shutoff both zones
 MANUAL OFF. Z1 Manual shutoff only Z1
 MANUAL OFF. Z2 Manual shutoff only Z2
3. MANUAL OFF Manual shutoff both zones *
 MANUAL OFF. Z1 Manual shutoff only Z1
 MANUAL OFF. Z2 Manual shutoff only Z2
4. EXT ALARM External Alarm *
 MANUAL OFF Manual shutoff both zones
 MANUAL OFF. Z1 Manual shutoff only Z1
 MANUAL OFF. Z2 Manual shutoff only Z2
 Z2 TOGGLE SETP Toggle setpoint

*Factory setting

Eckelmann

- Menu 6-2-5 Sensor Type

Select between values. Checkmark shows current setting.

SENSORS POS: XXXXX		Entry	Default
L243 ✓	Temperature range -50..50°C	↩	✓
K277	Temperature range -50..50°C	↩	
5K3A1	Temperature range 0..100°C	↩	

- Menu 6-3 Cooling

COOLING POS: XXXXX		Entry	Default
Min. On Time XX K	Minimum cooling ON time	0..15	2 m
Min. Off Time XX m	Minimum cooling OFF time	0..15	2 m
Cont Cool Mon. xx m	Duration of forced interruption of cooling in continuous running	--, 0..15	---m
Emergency Op. xx m	In failure of required sensors, the solenoid valve is actuated to adjust to the set opening in %.	0..100	100%

- Menu 6-4 Language

LANGUAGE POS: XXXXX	Entry	Default
Deutsch D ✓	↩	✓
English GB	↩	
Francais F	↩	
Espagnol E	↩	
Finnish FIN	↩	
Türkce TR	↩	
Cesky CZ	↩	

- Menu 6-5 Alarm priorities

ALARMPRIOS POS: XXXXX		Entry	Default
Prio.Refrig. Pt. X	Global alarm priority by refrigeration point priority (Menu 6-1) (Y)	↑, ↓, (Y,N)	N
Priority: XX	Show refrigeration point priority (Menu 6-1) Only shown when refrigeration point priority set to Y.		
<i>Following parameters are only shown when refrigeration point priority is set to N. Meaning of usable entries for alarm priority:--Event ignored 0=Message (entered only in message log) 1=Priority 1 alarm..99=Priority 99 alarm</i>			
Low Temp.	Temperature below lower alarm limit Priority applies to following alarms: Low Temp. Zone1, Low Temp. Zone2	-, 0..99	2
High Temp.	Temperature above upper alarm limit Priority applies to following alarms: High Temp. Zone1, High Temp. Zone2	-, 0..99	1
Sensor Fault	Temperature sensor failure	-, 0..99	2
No Defrost	No defrost within alarm delay interval Priority applies to following alarm: No defrost	-, 0..99	2
Timer-Term.Defr.	Defrosting terminated by safe defrost time	-, 0..99	0
Power Failure	Start following power failure	-, 0..99	0
First Start	Controller start up (basic settings loaded!)	-, 0..99	2
Manual Shutoff	Manual switch Input D31/D32 set OFF	-, 0..99	0
Hardware Fault	Internal hardware fault Priority applies to following alarms: EEPROM Fault, RTC Fault, Flash Fault	-, 0..99	1
Setpoint Change	Message generated on changing setpoint	0..99	0
Refrig.Pt.Dis.	Cooling by pack controller via CAN bus interrupted	-, 0..99	0
Battery Voltage	Battery low	-, 0..99	0

- Menu 6-6 Em.Powersupply (Emergency Power supply)

EM.POW.SUP POS: XXXXX		Entry	Default
Cool.funct.OFF xxx	Functionality of the cooling switched off during emergency power supply? (Y/N)	↑, ↓, (Y/N)	N
Defr.funct.OFF xxx	Functionality of the defrosting switched off during emergency power supply? (Y/N)	↑, ↓, (Y/N)	N
Fan funct. OFF xxx	Functionality of the fan switched off during emergency power supply? (Y/N)	↑, ↓, (Y/N)	N
Frame fct.OFF xxx	Functionality of the frame heater off during emergency power supply? (Y/N)	↑, ↓, (Y/N)	N
Light fct. OFF xxx	Functionality of the light during emergency power supply? (Y/N)	↑, ↓, (Y/N)	N

- Menu 6-7 Enhanced

ENHANCED POS: XXXXX	
1 SDS TEV	Move to menu 6-7-1
2 Service Mode	Move to menu 6-7-2

- Menu 6-7-1 SDS TEV

SDS TEV POS: XXXXX		Entry	Default
SDS TEV xx m	Principle participation of the controller in the suction pressure shift. (function COPT+). Note: This is transmitted via a CAN bus telegram and intervenes in the regulation!	↑ , ↓ , (ON/OFF)	OFF
Inact.a.Def xx m	Delay time following completion of the defrost before the controller actively intervenes in the shift.	0..40	30 min,
Dely_HystON xxxxm	Delay time for the reduction request with active cooling and overshoot of the hysteresis.	0..10	2.5 min
HiTmpZ1 dwn xxm	Delay time before the elapse of the high temperature alarm delay in zone 1, before the reduction is requested.	0..15	5 min.
HiTmpZ2 dwn xxm	Delay time before the elapse of the high temperature alarm delay in zone 2, before the reduction is requested.	0..15	5 min.
ToOvHystZ1 xxK	Tolerance limit above the setpoint plus hysteresis in zone 1. Influences when it is switched from stop to reduce.	0..20	2 K
ToOvHystZ2 xxK	Tolerance limit above the setpoint plus hysteresis in zone 2. Influences when it is switched from stop to reduce.	0..20	2 K
SwchSupRet xxx	Switching from supply air to return air and the reverse with temperature alarm delay time.	↑ , ↓ , (ON/OFF)	OFF
Dely_Switch xxxm	Switching from supply to return air: determines when it is switched within the delay time for the high temperature alarm.	0..15	5 min.
Add.Values xxx	Creation of additional (additive) "Debug" actual value archives in the system centre / store computer. Warning: This can force a reorganisation of the actual value archives – for this reason only use when required!	↑ , ↓ , (ON/OFF)	OFF
Incl_UpLim xxxK	Upper limit of the neutral zone for determining the incline.	0..5	0.3 K
Incl_LwLim xxxK	Lower limit of the neutral zone for determining the incline.	0..5	0.2 K

- Menu 6-7-2 Service Mode

SERVICIE MOD POS: XXXXX		Entry	Default
Relay 1 x	Relay 1 (terminal 15/16/18) switch on or off (1 or 0)	0 / 1	0
Relay 2 x	Relay 2 (terminal 25/26/28) switch on or off (1 or 0)	0 / 1	0
Relay 3 x	Relay 3 (terminal 35/36/38) switch on or off (1 or 0)	0 / 1	0
Relay 4 x	Relay 4 (terminal 43/44) switch on or off (1 or 0)	0 / 1	0
Relay 5 x	Relay 5 (terminal 53/54) switch on or off (1 or 0)	0 / 1	0
Relay 6 x	Relay 6 (terminal 64/65) switch on or off (1 or 0)	0 / 1	0
Relay 7 x	Relay 7 (terminal 73/74) switch on or off (1 or 0)	0 / 1	0
24V Out 1 x	Transistor output 1 (terminal 81/82) switch on or off (24 VDC / 50 mA)	0 / 1	0
24V Out 2 x	Transistor output 2 (terminal 91/92) switch on or off (24 VDC / 50 mA)	0 / 1	0
ANA OUT 1 xxxV	Analog output 1 (terminal 29/30) Default 0..10 VDC	0..10	0.0V
ANA OUT 2 xxxV	Analog output 2 (terminal 31/32) Default 0..10 VDC	0..10	0.0V
ANA IN 1 xxmA	Power analog input 1 (terminal 11/12) 4..20 mA	4..20	mA
ANA IN 2 xxmA	Power analog input 2 (terminal 11/14) 4..20 mA	4..20	mA
InputD 1 xxx	Status digital input 1 ON = 230 V AC voltage connected OFF = no voltage present	ON/OFF	-
InputD 2 xxx	Status digital input 2 ON = 230 V AC voltage connected OFF = no voltage present	ON/OFF	-
InputD 3 xxx	Status digital input 3 ON = 230 V AC voltage connected OFF = no voltage present	ON/OFF	-
InputD 4 xxx	Status digital input 4 ON = 230 V AC voltage connected OFF = no voltage present	ON/OFF	-

9.6 Controller type UA 141 - menu tree

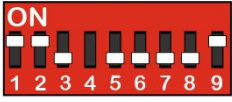
DIP switch S3	UA 141
	1: ON 2: ON 3: OFF 4: ON/OFF = Master / Slave mode ON/OFF 5..8: OFF 9: ON

Main menu	Submenu	Submenu 2	Menu number	Menu name
			0	REFRIGERATION POINT
Actual values			1	ACTUAL VALUES
	Temperature sensor		1-1	TEMPERATURE
	Cooling Zone 1		1-2	COOLING 1
	Defrost Zone 1		1-3	DEFROST 1
	–			
	Alarm		1-5	ALARM
	Pane heater		1-6	SCHEIBE
	Cooling Zone 2		1-7	COOLING 2
	Defrost Zone 2		1-8	DEFROST 2
Setpoints			2	SETPOINTS
	Cooling		2-1	COOLING
		Zone 1	2-1-1	COOLING 1
		Zone 2	2-1-2	COOLING 2
		Zone 1 U Toggle	2-1-3	COOLING 1U
		Zone 2 U Toggle	2-1-4	COOLING 2U
	Defrost		2-2	DEFROST
		Zone 1	2-2-1	DEFROST 1
		Zone 2	2-2-2	DEFROST 2
		Zone 1 U Toggle	2-2-3	DEFROST 1U
		Zone 2 U Toggle	2-2-4	DEFROST 2U
	–			

	Alarm	Zone 1	2-4-1	ALARM 1
		Zone 2	2-4-2	ALARM 2
		Zone 1 U Toggle	2-4-3	ALARM 1U
		Zone 2 U Toggle	2-4-4	ALARM 2U
	–			
	Pane heater		2-6	SCHEIBE
		Pane mode	2-6-1	SCHEIBE
Setpoints pane		2-6-2	SETPOINTS	
Clock		3	CLOCK	
	current time		3-1	CLOCK
	Defrost timer		3-2	DEFROST TIMER
		Abt.Uhr Z2	3-2-a	ABT.UHR Z2
	Toggle setpoints		3-3	UMSCHALTNG
Messages		4	MESSAGES	
	view		4-1	MESSAGES
	acknowledge		4-2	
	delete		4-3	MESSAGES
Archive		5	ARCHIVE	
Configuration		6	KONFIGURAT	
	Refrigeration point		6-1	REFRIGERATION POINT
	Controller		6-2	CONTROLLER
		Type and version	6-2-1	VERSION
		Temperature display	6-2-2	DISPLAY
		Alarm delay	6-2-3	ALARMVERZ.
		230 V inputs	6-2-4	230 V INPUTS
		Sensor type	6-2-5	SENSOR TYPE
	Cooling		6-3	COOLING
	Language		6-4	LANGUAGE
	Alarm priorities		6-5	ALARMPRIOS

Eckelmann

Emergency power operation		6-6	NOTNETZ
Advanced		6-7	ADVANCED
	SDS TEV	6-7-1	SDS TEV
	Service Mode	6-7-2	SERVICE MOD

9.6.1 Main menu UA 141

REFR. PT. POS: XXXXX	
1 Actual Values	Move to menu 1
2 Setpoints	Move to menu 2
3 Clock	Move to menu 3
4 Messages	Move to menu 4
5 Archive	Move to menu 5
6 Configuration	Move to menu 6

9.6.2 Menu 1 Actual Values UA 141

ACT VALUES POS: XXXXX	
1 Temp. Sensor	Move to menu 1-1
2 Cooling Zone 1	Move to menu 1-2
3 Defrost Zone 1	Move to menu 1-3
4	Not used with this controller type
5 Alarm	Move to menu 1-5
6 Pane Heater	Move to menu 1-6
7 Cooling Zone 2	Move to menu 1-7 Only shown when two-zone operation is set (Menu 6-1)
8 Defrost Zone 2	Move to menu 1-8 Only shown when two-zone operation is set (Menu 6-1)

- Menu 1-1 Temp. Sensor

TEMPERATUR Pos: XXXXX	
Temp. R2.1 xxx °C	Current supply air temperature Input Z11/ Z12
Temp. R4.1 xxx °C	Current return air temperature Input Z21/ Z22
Temp. R2.2 xxx °C	Current supply air temperature Input Z31/ Z32
Temp. R4.2 xxx °C	Current return air temperature Input Z41/ Z42
Temp. R2.3 xxx °C	Current supply air temperature Input Z51/ Z52
Temp. R4.3 xxx °C	Current return air temperature Input Z61/ Z62
Temp. R2.4 xxx °C	Current supply air temperature Input Z71/ Z72
Temp. R4.4 xxx °C	Current return air temperature Input Z81/ Z82

- Menu 1-2 Cooling Zone 1

COOLING 1 Pos: XXXXX	
Cooling xxx	Current ON/OFF status of cooling
Run Time xx %	Cooling relay on time during last day (00:00 - 24:00 hours)
Starts 0	Cooling relay actuations during last day
Temp. R2.1 xxx °C	Current supply air temperature Input Z11/Z12
Setpoint R2.1 xxx °C	Supply air temperature setpoint for comparison
Hystersis R2.1 xxx K	Supply air temperature hysteresis setpoint

COOLING 1 Pos: XXXXX	
Temp. R4.1 xxx °C	Current return air temperature Input Z21/Z22
Setpoint R4.1 xxx °C	Return air temperature setpoint for comparison
Hysteresis R4.1 xxx K	Return air temperature hysteresis setpoint

- Menu 1-3 Defrost Zone 1

DEFROST 1 Pos: XXXXX	
Defrost XXX	Current ON/OFF status of defrosting
Temp. R2.1 XXX °C	Current supply air temperature Input Z11/Z12
Temp. R2.2 XXX °C	Current supply air temperature Input Z31/Z32
Def. End. Tmp. XXX °C	Defrost termination temperature for comparison
Wait Time xx m	Waiting time setpoint
Drip Time xx m	Drain time setpoint
Last Defrost XX hh:mm	Day and time of last defrost cycle started
M/S Nof. Sl.	Number of parameterised and accessible MA slaves
M/S Lost Sl.	CAN address of the first MA slave which was not accessible during the last defrost
M/S Deifr.Sl.	Number of slaves currently undergoing a defrost
M/S DSIMat	List of MA slaves currently undergoing a defrost (can be scrolled through using ENTER)
DSq Nof. Sl.	Number of DS slaves (only in the case of DS master)
DSq Lost Sl.	CAN address of the first FA slave which was not accessible during the last defrost
DSq Deifr.Sl.	Number of slaves currently undergoing defrost
DSq DSIMat	List of FA slaves currently undergoing a defrost (can be scrolled through using ENTER)

- Menu 1-4
Not used with this controller type.

- Menu 1-5 Alarm

ALARM Pos: XXXXX	
Alarm Relay XXX	Current ON/OFF status of alarm output Terminal 15/16/18
Hi Temp Setp.1 XX °C	High temperature setpoint Zone 1
Lo Temp Setp.1 XX K	Low temperature setpoint Zone 1
Hi Temp Setp.2 XX °C	High temperature setpoint Zone 2;Only shown when two-zone operation is set (Menu 6-1)
Lo Temp Setp.2 XX K	Low temperature setpoint Zone 2;Only shown when two-zone operation is set (Menu 6-1)

- Menu 1-6 Pane Heater

PANE HTR XXXXX	
Pane Heater xxx	Current OFF/ON status of <i>pane heater output Terminal 73/74</i>
Run Time xxx %	Current on time of frame heater
Humidity xxx %	Current ambient air humidity (transmitted via CAN bus from pack controller with fitted ambient humidity sensor)
Room temp xx °C	Current ambient air temperature (transmitted via CAN bus from pack controller with fitted ambient temperature sensor)

- Menu 1-7 Cooling Zone 2

COOLING 2 XXXXX	
Cooling XXX	Current ON/OFF status of cooling
Run Time XX %	Cooling relay on time during last day (00:00 - 24:00 hours)
Starts 0	Cooling relay actuations during last day
Temp. R2.3 XXX °C	Current supply air temperature Input Z51/Z52
Setpoint R2.3 XXX °C	Supply air temperature setpoint for comparison
Hystersis R2.3 XXX K	Supply air temperature hysteresis setpoint
Temp. R4.3 XXX °C	Current return air temperature Input Z61/Z62
Setpoint R4.3 XXX °C	Return air temperature setpoint for comparison
Hystersis R4.3 XXX K	Return air temperature hysteresis setpoint

- Menu 1-8 Defrost Zone 2

DEFROST 2 Pos: XXXXX	
Defrost XXX	Current ON/OFF status of defrosting
Temp. R2.3 XXX °C	Current supply air temperature Input Z51/Z52
Temp. R2.4 XXX °C	Current supply air temperature Input Z71/Z72
Def. End. Tmp. XXX °C	Defrost termination temperature for comparison
Wait Time xx m	Waiting time setpoint
Drip Time xx m	Drain time setpoint
Last Defrst XX hh:mm	Day and time of last defrost cycle started

9.6.3 Menu 2 Setpoints UA 141

SETPOINTS POS: XXXXX	
1 Cooling	Menu 2-1; Special case: Move to menu 2-1-1 when single-zone operation is set (Menu 6-1) and setpoint toggle is disabled (Menu 3-3).
2 Defrost	Menu 2-2; Special case: Move to menu 2-2-1 when single-zone operation is set (Menu 6-1) and setpoint toggle is disabled (Menu 3-3).
3	Not used with this controller type
4 Alarm	Menu 2-4; Special case: Move to menu 2-4-1 when single-zone operation is set (Menu 6-1) and setpoint toggle is disabled (Menu 3-3).
5	Not used with this controller type
6 Pane Heater	Move to menu 2-6

- Menu 2-1 Cooling

COOLING POS: XXXXX	
1 Zone 1	Menu 2-1-1
2 Zone 2	Menu 2-1-2 Only shown when two-zone operation is set (Menu 6-1)
3 Zone 1A Altern.	Menu 2-1-3 Not shown when setpoint toggle is disabled (Menu 3-3)
4 Zone 2A Altern.	Menu 2-1-4 Only shown when two-zone operation is set (Menu 6-1) and setpoint toggle is not disabled (Menu 3-3)

- Menu 2-1-1 Zone 1

COOLING 1 POS: XXXXX		Entry	Default
Setpoint R2.1 XXX °C	Supply air temperature setpoint	-20..20	-4 °C
Hysteresis R2.1 X K	Supply air temperature hysteresis setpoint	1..8	4 K
Setpoint R4.1 XXX °C	Return air temperature setpoint for comparison	-15..20	2 °C
Hysteresis R4.1 X K	Return air temperature hysteresis setpoint	1..8	2 K
Humid. On Time 0m	Humidifier on time Only shown when single-zone operation is set (Menu 6-1)	--, 0..15	5 m

- Menu 2-1-2 Zone 2

COOLING 2 POS: XXXXX		Entry	Default
Setpoint R2.3 XXX °C	Supply air temperature setpoint	-20..20	-4 °C
Hystersis R2.3 X K	Supply air temperature hysteresis setpoint	1..8	4 K
Setpoint R4.3 XXX °C	Return air temperature setpoint for comparison	-15..20	2 °C
Hystersis R4.3 X K	Return air temperature hysteresis setpoint	1..8	2 K

- Menu 2-1-3 Zone 1A Altern.

COOLING 1A POS: XXXXX		Entry	Default
Setpoint R2.1 XXX °C	Supply air temperature setpoint	-20..20	-2 °C
Hystersis R2.1 X K	Supply air temperature hysteresis setpoint	1..8	4 K
Setpoint R4.1 XXX °C	Return air temperature setpoint for comparison	-15..20	2 °C
Hystersis R4.1 X K	Return air temperature hysteresis setpoint	1..8	2 K
Humid. On Time 0m	Humidifier on time Only shown when single-zone operation is set (Menu 6-1)	--, 0..15	5 m

- Menu 2-1-4 Zone 2A Altern.

COOLING 2A POS: XXXXX		Entry	Default
Setpoint R2.3 XXX °C	Supply air temperature setpoint	-20..20	-2 °C
Hystersis R2.3 X K	Supply air temperature hysteresis setpoint	1..8	4 K
Setpoint R4.3 XXX °C	Return air temperature setpoint for comparison	-15..20	2 °C
Hystersis R4.3 X K	Return air temperature hysteresis setpoint	1..8	2 K

- Menu 2-2 Defrost

DEFROST POS: XXXXX	
1 Zone 1	Menu 2-2-1
2 Zone 2	Menu 2-2-2 Only shown when two-zone operation is set (Menu 6-1)
3 Zone 1A Altern.	Menu 2-2-3 Not shown when setpoint toggle is disabled (Menu 3-3)
4 Zone 2A Altern.	Menu 2-2-4 Only shown when two-zone operation is set (Menu 6-1) and setpoint toggle is not disabled (Menu 3-3)

- Menu 2-2-1 Zone 1

DEFROST 1 POS: XXXXX		Entry	Default
Def. End. Tmp. XX °C	Defrost termination temperature setpoint	--, 5..20	8 °C
Wait Time xx m	Waiting time setpoint between cooling and defrosting	0..15	0 m
Drip Time x m	Waiting time (drain time) setpoint between defrosting and cooling	0..15	0 m
M/S Degiv.Fct. XXX	Configuration of the defrost via CAN bus function. For details see chapter Master-Slave-Modus - Abtau-Synchronisation über CAN-Bus .	OFF, MASTR, SLAVE	OFF
M/S CAN Adr. XXX	Selection of the controller (1..99) participating in the defrost via CAN bus which is the master. "--", if this controller is itself master(Parameter <i>M/S Degiv.Fct.</i> = MASTR)	---, 1..99	–
DS-Function XXX	Configuration of the defrost sequence function (DS).For details see chapter Folgeabtauung (FA) über CAN-Bus .	OFF, MASTR, SLAVE	OFF
DS-Group XXX	Selection of which group a defrost sequence of this controller (1..99) belongs to.	---, 1..99	–
DS-Master XXX	Selection of which controller (1..99) participating in the defrost sequence is the master. "--", if this controller is itself the master(Parameter <i>DS-Function</i> = MASTR)	---, 1..99	–
DS-Wait time XXXm	Wait time for the defrost sequence	0..127	1 min

- Menu 2-2-2 Zone 2

DEFROST 2 POS: XXXXX		Entry	Default
Def. End. Tmp. XX °C	Defrost termination temperature setpoint	--, 5..20	8 °C
Wait Time xx m	Waiting time setpoint between cooling and defrosting	0..15	0 m
Drip Time x m	Waiting time (drain time) setpoint between defrosting and cooling	0..15	0 m

- Menu 2-2-3 Zone 1A Altern.

DEFROST 1A POS: XXXXX		Entry	Default
Def. End. Temp. XX °C	Defrost termination temperature setpoint	--, 5..20	5 °C
Wait Time xx m	Waiting time setpoint between cooling and defrosting	0..15	0 m
Drip Time x m	Waiting time (drain time) setpoint between defrosting and cooling	0..15	0 m

- Menu 2-2-4 Zone 2A Altern.

DEFROST 2A POS: XXXXX		Entry	Default
Def. End. Temp. XX °C	Defrost termination temperature setpoint	--, 5..20	5 °C
Wait Time xx m	Waiting time setpoint between cooling and defrosting	0..15	0 m
Drip Time x m	Waiting time (drain time) setpoint between defrosting and cooling	0..15	0 m

- Menu 2-3
Not used with this controller type.
- Menu 2-4 Alarm

ALARM POS: XXXXX	
1 Zone 1	Menu 2-4-1
2 Zone 2	Menu 2-4-2 Only shown when two-zone operation is set (Menu 6-1)
3 Zone 1A Altern.	Menu 2-4-3 Not shown when setpoint toggle is disabled (Menu 3-3)
4 Zone 2A Altern.	Menu 2-4-4 Only shown when two-zone operation is set (Menu 6-1) and setpoint toggle is not disabled (Menu 3-3)

- Menu 2-4-1 Zone 1

ALARM 1 POS: XXXXX		Entry	Default
High Temp Setp XX °C	High temperature setpoint at which <i>High Temperature</i> alarm is generated	-10..30	6 °C
Low Temp Setp. XX K	Low temperature setpoint (difference below temperature control setpoint) at which <i>Low Temperature</i> alarm is generated	--, 0..6	4 K

- Menu 2-4-2 Zone 2

ALARM 2 POS: XXXXX		Entry	Default
High Temp Setp XX °C	High temperature setpoint at which <i>High Temperature</i> alarm is generated	-10..30	6 °C

Eckelmann

ALARM 2 POS: XXXXX		Entry	Default
Low Temp Setp. XX K	Low temperature setpoint (difference below temperature control setpoint) at which <i>Low Temperature</i> alarm is generated	--, 0..6	4 K

- Menu 2-4-3 Zone 1A Altern.

ALARM 1A POS: XXXXX		Entry	Default
High Temp Setp XX °C	High temperature setpoint at which <i>High Temperature</i> alarm is generated	-10..30	6 °C
Low Temp Setp. XX K	Low temperature setpoint (difference below temperature control setpoint) at which <i>Low Temperature</i> alarm is generated	--, 0..6	4 K

- Menu 2-4-4 Zone 2A Altern.

ALARM 2A POS: XXXXX		Entry	Default
High Temp Setp XX °C	High temperature setpoint at which <i>High Temperature</i> alarm is generated	-10..30	6 °C
Low Temp Setp. XX K	Low temperature setpoint (difference below temperature control setpoint) at which <i>Low Temperature</i> alarm is generated	--, 0..6	4 K

- Menu 2-5
Not used with this controller type
- Menu 2-6 Pane Heater

PANE HTR POS: XXXXX	
1 Mode Pane	Move to menu 2-6-1
2 Setpoint Pane	Move to menu 2-6-2

- Menu 2-6-1 Mode Scheibe

Select between values. Checkmark shows current setting.

PANE HTR POS: XXXXX		Entry	Default
fixed run time ✓	Pane heater fixed on time	↙	✓
enthalpy-ctrl rtm	Enthalpy control by ambient air temperature and humidity	↙	

- Menu 2-6-2 Setpoint Pane

SETPOINTS POS: XXXXX		Entry	Default
Mod: xxxxxxxxxxxx	Set frame heater mode (Menu 2-6-1)		Fixed on time
Mod: fixed run time xx m	Pane heater on time after actuation of Digital Input 3 (Terminal D31 and D32)	0..120	60 m
Run Time XXX %	Fixed on time, Only shown when mode set to Fixed On Time (Menu 2-6-1)	--, 0..100	0 %
emerg.run time XXX %	On time in failure of ambient air humidity or temperature signal (via CAN bus) Only shown when mode set to Enthalpy Control (Menu 2-6-1)	--, 0..100	0 %

Eckelmann

SETPOINTS POS: XXXXX		Entry	Default
enthalp. offs. XXX %	Offset to on time with activated enthalpy control (via CAN bus) Only shown when mode set to Enthalpy Control (Menu 2-6-1)	-50..50	0 %
Invert Output xxx	Inversion of the function of the pane heater output (terminals 91/92)	(ON/OFF)	ON

9.6.4 Menu 3 Clock UA 141

CLOCK POS: XXXXX	
1 Current Time	Move to menu 3-1
2 Defrost timer	Move to menu 3-2
3 Toggle Setpoints	Move to menu 3-3
4 Automatic ON	Move to menu 3-4

- Menu 3-1 Current Time

i Time is defined by time master (system centre / store computer / operator terminal) when CAN bus is connected. Any entry made will then be overwritten by the defined value.

CLOCK POS: XXXXX		Entry	Default
Date: XX dd.mm.yy	Display and enter current weekday, date	dd.mm.yy	
Time: hh.mm	Display and enter current time	hh.mm	
Daylight Saving X	Display and enter automatic daylight saving change (Y/N)	↑, ↓, (Y/N)	J

- Menu 3-2 Defrost timer

DERF. TIMER POS: XXXXX		Entry	Default
Defrost timer XXX	Defrost initiation via input D11/12 (EXT) or internal (INT)	↑, ↓, (EXT, INT)	INT
Safe Defr Time XXX m	Safe defrost time for maximum allowed duration of defrosting (used only for internal defrosting)	0..180	150 min
Manual Defrost XXX	Status (OFF/ON) for supplementary manual defrosting *) shown only when parameter defrost timer = INT	↑, ↓, (ON/OFF)	OFF
Def.Tim.Z2	Separate defrost timer for zone 2	Menu 3-2-a	
Defr. 1 xxxxx hh:mm	Defrost start time with internal defrosting; Weekday, time; shown only when parameter defrost timer = INT	↑, ↓, (Mo-Su etc.) or numbers (hh:mm)	Mo-Su03:00
...			
Defr. 14 xxxxx hh:mm			

i *) Parameter automatically set to ON for safe defrost time at first start.

• Menu 3-2-a Def.Tim.Z2

DEFR.TIMER POS: XXXXX		Entry	Default
Defrost Timer XXX	Setting for how temperature zone 2 should defrost:- MitZ1 Together with zone 1- INT Internally- EXT Externally – the defrost of both temperature zones is started simultaneously via the external signal	↑ ↓ , (ViaZ1(ViaZ1,EXT,INT))	ViaZ1
Safe Defr Time XXX m	Safe defrost time, i.e. max. allowed duration of defrosting (internal defrost only)	0..120	60 min
Manual Defrost XXX	Status (ON/OFF) of auxiliary manual defrost *)	↑ ↓ , (ON/OFF)	OFF
Defr. 1 xxxxx hh:mm	Defrost start time for internal defrost; weekday, time of day; shown only when parameter <i>defrost timer</i> = INT	↑ ↓ , (Mo-Su) or numbers (hh:mm)	Mo-Su01:00
...			
Defr. 14 xxxxx hh:mm			

• Menu 3-3 Toggle Setpoints

TOGGLE POS: XXXXX		Entry	Default
Status XXX	Setpoint toggle status (OFF/ON) of alternative set of setpoints (setpoint toggle)		
Toggle Setp. XXX	Setpoint toggle via <ul style="list-style-type: none"> • EXT digital input D21/22 • INT internal timer • CAN bus- „-“ deactivated 	↑ ↓ , (EXT, INT, CAN, --)	EXT
Alt ON: DD-DD hh:mm	Start time for toggle to alternative set of setpoints Weekday from - to XXXXX, time hh:mm Only shown when internal setpoint toggle is activated (Menu 3-3)	↑ ↓ , (Mo-Su etc.) or numbers (hh:mm)	Mo-Su 21:00
AltOFF: DD-DD hh:mm	End time for toggle to alternative set of setpoints Weekday from - to XXXXX, time hh:mm Only shown when internal setpoint toggle is activated (Menu 3-3)	↑ ↓ , (Mo-Su etc.) or numbers (hh:mm)	Mo-Su 05:00
Alt ON: DD-DD hh:mm	Start time for toggle to alternative set of setpoints Weekday from - to XXXXX, time hh:mm Only shown when internal setpoint toggle is activated (Menu 3-3)	↑ ↓ , (Mo-Su etc.) or numbers (hh:mm)	Su 05:00
AltOFF: DD-DD hh:mm	End time for toggle to alternative set of setpoints Weekday from - to XXXXX, time hh:mm Only shown when internal setpoint toggle is activated (Menu 3-3)	↑ ↓ , (Mo-Su etc.) or numbers (hh:mm)	Su 21:00

Eckelmann

TOGGLE POS: XXXXX		Entry	Default
...	A total of 7 different ON and OFF toggle times can be defined. A toggle time will only be obeyed when a <u>matched pair</u> of on and off times is set as a parameter.		

Eckelmann

- Menu 3-4 Automatic ON

 Parameters are shown and can be adjusted when setpoint toggle is set to "INT" or "--" (Menu 3-3).

AUTOM. ON POS: XXXXX		Entry	Default
ON 1 DD-DD hh:mm	Automatic start 1	↑, ↓, (Mo-Su etc.) or numbers (hh:mm)	Mo 06:00
ON 2 DD-DD hh:mm	Automatic start 2	↑, ↓, (Mo-Su etc.) or numbers (hh:mm)	-----
...	Automatic start 7 (7 times of Automatic ON are possible)		

9.6.5 Menu 4 Messages UA 141

MESSAGES POS: XXXXX	
1 View	Move to menu 4-1: Show Message Log
2 Acknowledge	Messages in message log are cancelled. <i>"Alarms Cancelled!"</i> shown in display: Press ESC to go back.
3 Delete	Move to menu 4-2: Delete Message Log (with prompt)

- Menu 4-1 View Messages

MESSAGES POS: XXXXX	
Error Message 1:	Fault 1 message text
dd.mm.yy hh:mm ON	Start of Fault 1
dd.mm.yy hh:mm OFF	End of Fault 1 (only when Fault 1 terminated)
...	
Error Message n:	Fault n message text
dd.mm.yy hh:mm ON	Start of Fault n
dd.mm.yy hh:mm OFF	End of Fault n (only when Fault n terminated)

- Menu 4-2 Acknowledge Messages
This displays the *"Alarms Cancelled!"* message.
- Menu 4-3 Delete Messages

MESSAGES POS: XXXXX		Entry
Delete! Are you sure? No: ESC YES: ↵	Safety prompt for deleting messages Press ESC to go back after cancelling messages.	↵, ESC

9.6.6 Menu 5 Archive UA 141

ARCHIVE POS: XXXXX	
dd.mm.yy hh:mm	Time of archiving Record 1
Zone 1: abcdef x °C	Status and temperature of Zone 1, see Note
Zone 2: abcdef x °C	Status and temperature of Zone 2, see Note Only shown when two-zone operation is set (Menu 6-1)
...	
dd.mm.yy hh:mm	Time of archiving Record n
Zone 1: abcdef x °C	Status and temperature of Zone 1, see Note
Zone 2: abcdef x °C	Status and temperature of Zone 2, see Note Only shown when two-zone operation is set (Menu 6-1)

 *) Status abcdef covers following states of refrigeration point. The entry at this position is - when a state is not active. Example Zone 1: abcdef x °C

	Single-zone operation resp. Operator interface BT 300	Two-zone operation
a	O = Operation	O = Operation
b	R = Refrigeration / Cooling	R = Refrigeration / Cooling
c	R = Refrigeration/ Cooling	D = Defrost
d	D = Defrost	G = Gate / Door (cold-room controller only)
e	G = Gate / Door (cold-room controller only)	A = Alarm
f	A = Alarm	

9.6.7 Menu 6 Configuration UA 141

CONFIGURAT POS: XXXXX	
1 Refriger. Point	Move to menu 6-1
2 Controller	Move to menu 6-2
3 Cooling	Move to menu 6-3
4 Language	Move to menu 6-4
5 Alarm priorities	Move to menu 6-5
6 Em.Powersupply	Move to menu 6-6
7 Enhanced	Move to menu 6-7

- Menu 6-1 Refriger. Point

REFR. PT. POS: XXXXX		Entry	Default
Refr. Pt. Name:	Text only		
xxxxxxxxxxxxxxxx	Free text entry describing refrigeration point (see note)		Kühlstellenregler
Item ID: XXXXX	Free text entry displayed in screens after ITEM ID (see note)		UA400
Priority: XX	Alarm priority in failure of refrigeration point or when global controller priority is set (Menu 6-5)	↑, ↓, or numbers (0..99)	1
Refr. Sys. No.: XX	No. of pack controller allocated to case/cold-room controller	↑, ↓, or numbers (1..9)	1
Refr. Sys. Type XXX	Associated compressor pack. Parameter only required when linked to a VS 3010 BS having several zones. If a different type of pack controller is used, set this parameter blank (---)	↑, ↓, or numbers (---, Z1, Z2)	—
Temp. Zones X	Number of temperature zones Single-zone operation Two-zone operation	↑, ↓, or numbers (1, 2)	2
No. Sensors XX	Number of temperature sensors connected. After entering ↵ sensor scan is performed to redetermine the number of sensorium of sensors	↵	

⚠ The priority must be assigned between 0..2 by older versions of the store computer (<V5.0), see chapter [Alarms and Messages of UA 400](#).

- ① A meaningful name that describes the refrigeration point in more detail should be entered, e.g. Cheese Counter 2 and CC2. Entry is made in the screens on system centre, store computer or operator terminal. Direct entry cannot be made in the controller screens displayed on the operator terminal. Entry cannot be made either on operator interface BT 300.

- Menu 6-2 Controller

CONTROLLER POS: XXXXX	
1 Type and Version	Move to menu 6-2-1
2 Temp. Display	Move to menu 6-2-2
3 Alarm Delay	Move to menu 6-2-3
4 230V Inputs	Move to menu 6-2-4
5 Sensor Type	Move to menu 6-2-5

- Menu 6-2-1 Type and Version

VERSION POS: XXXXX		Entry	Default
Ctrlr. Type XXXXXXXX	Controller type set by DIP Switch S3	–	UA141
Software Ver.: XXXX	Software version of case/cold-room controller	–	x.yy
Serial No.: XXXXXXX	Device No. of case/cold-room controller	–	
Master/Sl. Mode XXX	Synchronized defrosting in master-slave mode (ON/OFF)	–	

- Menu 6-2-2 Temp. Display

DISPLAY POS: XXXXX		Entry	Default
Offset XX K	Offset for temperature display	-10..10	0K
Alarm symbol X	Show alarm symbol on BT 30 Temperature Display	↑, ↓, (Y/N)	N

- Menu 6-2-3 Alarm Delay

ALARMDELAY POS: XXXXX		Entry	Default
Sensor Fault XX m	Sensor break alarm delay	0..30	15 min
High/Low Temp. XX m	High/low temperature alarm delay	0..120	90 min
No Defrost XX h	No defrost alarm delay	--, 2..168	50 h
Selfholding X	NO: Automatic reset of non- transient alarms. YES: Alarms must be reset manually.	↑, ↓, (Y/N)	N

Eckelmann

- Menu 6-2-4 230V Inputs

⚠ Only trained personnel should be allowed to change inputs, as changes may affect other functions.

230V INPUT POS: XXXXX		Entry	Default
Entry1: XXXXXXXXXXXX	Function of digital input 1 D11/D12	1)	DEFR.TIMER
Entry2: XXXXXXXXXXXX	Function of digital input 2 D21/D22	2)	TOGGLE SETP.
Entry3: XXXXXXXXXXXX	Function of digital input 3 D31/D32	3)	PANE HTR SW.
Entry4: XXXXXXXXXXXX	Function of digital input 4 D41/D42	4)	Extern.Alarm
XXXXXXXXXXXXXXXXXXXX	Freely configurable alarm text for digital input 4,the default text is "CO2-Alarm"	Text	CO2-ALARM
Inv. D1 XXX	Inverting of digital input 1	↑ , ↓ , (ON/OFF)	OFF
Inv. D2 XXX	Inverting of digital input 2		OFF
Inv. D3 XXX	Inverting of digital input 3		OFF
Inv. D4 XXX	Inverting of digital input 4		OFF

Possible settings for the digital inputs:

1. DEFR.TIMER Defrost timer*
 MANUAL OFF. Manual shutoff both zones
 MANUAL OFF. Z1 Manual shutoff only Z1
 MANUAL OFF. Z2 Manual shutoff only Z2
 Z2 TOGGLE SETP. Toggle setpoint
2. TOGGLE SETP Toggle setpoint *
 MANUAL OFF Manual shutoff both zones
 MANUAL OFF. Z1 Manual shutoff only Z1
 MANUAL OFF. Z2 Manual shutoff only Z2
3. PANE HTR SW. Pane heater switch *
 MANUAL OFF Manual shutoff both zones *
 MANUAL OFF. Z1 Manual shutoff only Z1
 MANUAL OFF. Z2 Manual shutoff only Z2
4. EXT ALARM External Alarm *
 MANUAL OFF Manual shutoff both zones
 MANUAL OFF. Z1 Manual shutoff only Z1
 MANUAL OFF. Z2 Manual shutoff only Z2
 TOGGLE SETP Toggle setpoint

*Factory setting

Eckelmann

- Menu 6-2-5 Sensor Type

Select between values. Checkmark shows current setting.

SENSORS POS: XXXXX		Entry	Default
L243 ✓	Temperature range -50..50°C	↩	✓
K277	Temperature range -50..50°C	↩	
5K3A1	Temperature range 0..100°C	↩	

- Menu 6-3 Cooling

COOLING POS: XXXXX		Entry	Default
Min. On Time XX K	Minimum cooling ON time	0..15	2 m
Min. Off Time XX m	Minimum cooling OFF time	0..15	2 m
Cont Cool Mon. xx m	Duration of forced interruption of cooling in continuous running	--, 0..15	— m
Emergency Op. xx m	In failure of required sensors, the solenoid valve is actuated to adjust to the set opening in %.	0..100	100%

- Menu 6-4 Language

LANGUAGE POS: XXXXX	Entry	Default
Deutsch D ✓	↩	✓
English GB	↩	
Francais F	↩	
Espagnol E	↩	
Finnish FIN	↩	
Türkce TR	↩	
Cesky CZ	↩	

- Menu 6-5 Alarm priorities

ALARMPRIOS POS: XXXXX		Entry	Default
Prio.Refrig. Pt. X	Global alarm priority by refrigeration point priority (Menu 6-1) (Y)	↑, ↓, (Y,N)	N
Priority: XX	Show refrigeration point priority (Menu 6-1) Only shown when refrigeration point priority set to Y.		
<i>Following parameters are only shown when refrigeration point priority is set to N. Meaning of usable entries for alarm priority:--Event ignored 0=Message (entered only in message log) 1=Priority 1 alarm..99=Priority 99 alarm</i>			
Low Temp.	Temperature below lower alarm limit Priority applies to following alarms: Low Temp. Zone1, Low Temp. Zone2	-, 0..99	2
High Temp.	Temperature above upper alarm limit Priority applies to following alarms: High Temp. Zone1, High Temp. Zone2	-, 0..99	1
Sensor Fault	Temperature sensor failure	-, 0..99	2
No Defrost	No defrost within alarm delay interval Priority applies to following alarm: No defrost	-, 0..99	2
Timer-Term.Defr.	Defrosting terminated by safe defrost time	-, 0..99	0
Power Failure	Start following power failure	-, 0..99	0
First Start	Controller start up (basic settings loaded!)	-, 0..99	2
Manual Shutoff	Manual switch Input D31/D32 set OFF	-, 0..99	0
Hardware Fault	Internal hardware fault Priority applies to following alarms: EEPROM Fault, RTC Fault, Flash Fault	-, 0..99	1
Setpoint Change	Message generated on changing setpoint	0..99	0
Refrig.Pt.Dis.	Cooling by pack controller via CAN bus interrupted	-, 0..99	0
Battery Voltage	Battery low	-, 0..99	0

- Menu 6-6 Em.Powersupply (Emergency Power supply)

EM.POW.SUP POS: XXXXX		Entry	Default
Cool.funct.OFF xxx	Functionality of the cooling switched off during emergency power supply? (Y/N)	↑, ↓, (Y/N)	N
Defr.funct.OFF xxx	Functionality of the defrosting switched off during emergency power supply? (Y/N)	↑, ↓, (Y/N)	N
Fan funct. OFF xxx	Functionality of the fan switched off during emergency power supply? (Y/N)	↑, ↓, (Y/N)	N
Frame fct.OFF xxx	Functionality of the frame heater off during emergency power supply? (Y/N)	↑, ↓, (Y/N)	N
Light fct. OFF xxx	Functionality of the light during emergency power supply? (Y/N)	↑, ↓, (Y/N)	N

- Menu 6-7 Enhanced

ENHANCED POS: XXXXX	
1 SDS TEV	Move to menu 6-7-1
2 Service Mode	Move to menu 6-7-2

- Menu 6-7-1 SDS TEV

SDS TEV POS: XXXXX		Entry	Default
SDS TEV xx m	Principle participation of the controller in the suction pressure shift. (function COPT+). Note: This is transmitted via a CAN bus telegram and intervenes in the regulation!	↑ , ↓ , (ON/OFF)	OFF
Inact.a.Def xx m	Delay time following completion of the defrost before the controller actively intervenes in the shift.	0..40	30 min,
Dely_HystON xxxxm	Delay time for the reduction request with active cooling and overshoot of the hysteresis.	0..10	2.5 min
HiTmpZ1 dwn xxm	Delay time before the elapse of the high temperature alarm delay in zone 1, before the reduction is requested.	0..15	5 min.
HiTmpZ2 dwn xxm	Delay time before the elapse of the high temperature alarm delay in zone 2, before the reduction is requested.	0..15	5 min.
ToOvHystZ1 xxK	Tolerance limit above the setpoint plus hysteresis in zone 1. Influences when it is switched from stop to reduce.	0..20	2 K
ToOvHystZ2 xxK	Tolerance limit above the setpoint plus hysteresis in zone 2. Influences when it is switched from stop to reduce.	0..20	2 K
SwchSupRet xxx	Switching from supply air to return air and the reverse with temperature alarm delay time.	↑ , ↓ , (ON/OFF)	OFF
Dely_Switch xxxm	Switching from supply to return air: determines when it is switched within the delay time for the high temperature alarm.	0..15	5 min.
Add.Values xxx	Creation of additional (additive) "Debug" actual value archives in the system centre / store computer. Warning: This can force a reorganisation of the actual value archives – for this reason only use when required!	↑ , ↓ , (ON/OFF)	OFF
Incl_UpLim xxxK	Upper limit of the neutral zone for determining the incline.	0..5	0.3 K
Incl_LwLim xxxK	Lower limit of the neutral zone for determining the incline.	0..5	0.2 K

- Menu 6-7-2 Service Mode

SERVICIE MOD POS: XXXXX		Entry	Default
Relay 1 x	Relay 1 (terminal 15/16/18) switch on or off (1 or 0)	0 / 1	0
Relay 2 x	Relay 2 (terminal 25/26/28) switch on or off (1 or 0)	0 / 1	0
Relay 3 x	Relay 3 (terminal 35/36/38) switch on or off (1 or 0)	0 / 1	0
Relay 4 x	Relay 4 (terminal 43/44) switch on or off (1 or 0)	0 / 1	0
Relay 5 x	Relay 5 (terminal 53/54) switch on or off (1 or 0)	0 / 1	0
Relay 6 x	Relay 6 (terminal 64/65) switch on or off (1 or 0)	0 / 1	0
Relay 7 x	Relay 7 (terminal 73/74) switch on or off (1 or 0)	0 / 1	0
24V Out 1 x	Transistor output 1 (terminal 81/82) switch on or off (24 VDC / 50 mA)	0 / 1	0
24V Out 2 x	Transistor output 2 (terminal 91/92) switch on or off (24 VDC / 50 mA)	0 / 1	0
ANA OUT 1 xxxV	Analog output 1 (terminal 29/30) Default 0..10 VDC	0..10	0.0V
ANA OUT 2 xxxV	Analog output 2 (terminal 31/32) Default 0..10 VDC	0..10	0.0V
ANA IN 1 xxmA	Power analog input 1 (terminal 11/12) 4..20 mA	4..20	mA
ANA IN 2 xxmA	Power analog input 2 (terminal 11/14) 4..20 mA	4..20	mA
InputD 1 xxx	Status digital input 1 ON = 230 V AC voltage connected OFF = no voltage present	ON/OFF	-
InputD 2 xxx	Status digital input 2 ON = 230 V AC voltage connected OFF = no voltage present	ON/OFF	-
InputD 3 xxx	Status digital input 3 ON = 230 V AC voltage connected OFF = no voltage present	ON/OFF	-
InputD 4 xxx	Status digital input 4 ON = 230 V AC voltage connected OFF = no voltage present	ON/OFF	-

9.7 Controller type UA 141 NK - menu tree

DIP switch S3	UR 141 NK
	1: OFF 2: OFF 3: ON 4: ON/OFF = Master / Slave mode ON/OFF 5..8: OFF 9: ON

Main menu	Submenu	Submenu 2	Menu number	Menu name
			0	REFRIGERATION POINT
Actual values			1	ACTUAL VALUES
	Temperature sensor		1-1	TEMPERATURE
	Cooling Zone 1		1-2	COOLING 1
	Defrost Zone 1		1-3	DEFROST 1
	Fans Zone 1		1-4	FAN 1
	Alarm		1-5	ALARM
	Frame heater		1-6	FRAME HEATER
	Cooling Zone 2		1-7	COOLING 2
	Defrost Zone 2		1-8	DEFROST 2
	Fans Zone 2		1-9	FAN 2
Setpoints			2	SETPOINTS
	Cooling		2-1	COOLING
		Zone 1	2-1-1	COOLING 1
		Zone 2	2-1-2	COOLING 2
		Zone 1 U Umschalt.	2-1-3	COOLING 1U
		Zone 2 U Umschalt.	2-1-4	COOLING 2U
	Defrost		2-2	DEFROST
		Zone 1	2-2-1	DEFROST 1
		Zone 2	2-2-2	DEFROST 2
		Zone 1 U Umschalt.	2-2-3	DEFROST 1U
		Zone 2 U Umschalt.	2-2-4	DEFROST 2U

	Condenser Fans		2-3	CONDENSER FANS	
		Zone 1	2-3-1	FAN 1	
		Zone 2	2-3-2	FAN 2	
		Zone 1 U Umschalt.	2-3-3	LÜFTER 1U	
		Zone 2 U Umschalt.	2-3-4	LÜFTER 2U	
	Alarm			2-4	ALARM
		Zone 1		2-4-1	ALARM 1
		Zone 2		2-4-2	ALARM 2
		Zone 1 U Umschalt.		2-4-3	ALARM 1U
		Zone 2 U Umschalt.		2-4-4	ALARM 2U
Frame heater			2-5	RAHMENHEIZ	
	Frame heater mode		2-5-1	FRAME HEATER	
	Frame heater setpoints		2-5-2	SETPOINTS	
	Toggle mode		2-5-3	RAHMEN UM.	
	Toggle setpoints		2-5-4	SOLLW. UM.	
Clock			3	CLOCK	
	current time		3-1	CLOCK	
	Defrost timer		3-2	DEFROST TIMER	
		Abt.Uhr Z2		3-2-a	ABT.UHR Z2
	Toggle setpoints		3-3	UMSCHALTNG	
Messages			4	MESSAGES	
	view		4-1	MESSAGES	
	acknowledge		4-2		
	delete		4-3	MESSAGES	
Archive			5	ARCHIVE	
Configuration			6	KONFIGURAT	
	Refrigeration point		6-1	REFRIGERATION POINT	
	Controller		6-2	CONTROLLER	
		Type and version		6-2-1	VERSION

	Temperature display	6-2-2	DISPLAY
	Alarm delay	6-2-3	ALARMVERZ.
	230 V inputs	6-2-4	230 V INPUTS
	Sensor type	6-2-5	SENSOR TYPE
Cooling		6-3	COOLING
Language		6-4	LANGUAGE
Alarm priorities		6-5	ALARMPRIOS
Emergency power operation		6-6	NOTNETZ
Advanced		6-7	ADVANCED
	SDS TEV	6-7-1	SDS TEV
	Service Mode	6-7-2	SERVICE MOD

9.7.1 Main menu UR 141 NK

REFR. PT. POS: XXXXX	
1 Actual Values	Move to menu 1
2 Setpoints	Move to menu 2
3 Clock	Move to menu 3
4 Messages	Move to menu 4
5 Archive	Move to menu 5
6 Configuration	Move to menu 6

9.7.2 Menu 1 Actual Values UR 141 NK

ACT VALUES POS: XXXXX	
1 Temp. Sensor	Move to menu 1-1
2 Cooling Zone 1	Move to menu 1-2
3 Defrost Zone 1	Move to menu 1-3
4 Evap. fan Zone 1	Move to menu 1-4
5 Alarm	Move to menu 1-5
6 Frame Heater	Move to menu 1-6
7 Cooling Zone 2	Move to menu 1-7 Only shown when two-zone operation is set (Menu 6-1)
8 Defrost Zone 2	Move to menu 1-8 Only shown when two-zone operation is set (Menu 6-1)
9 FANS Zone 2	Move to menu 1-9 Only shown when two-zone operation is set (Menu 6-1)

- Menu 1-1 Temp. Sensor

TEMPERATUR Pos: XXXXX	
Temp. R4.1 xxx °C	Current room air temperature Input Z21/ Z22
Temp. R1.1 xxx °C	Current evaporator temperature Input Z31/ Z32
Temp. R4.2 xxx °C	Current room air temperature Input Z41/ Z42
Temp. R1.2 xxx °C	Current evaporator temperature Input Z51/ Z52
Temp. R4.3 xxx °C	Current room air temperature Input Z71/ Z72
Temp. R1.3 xxx °C	Current evaporator temperature Input Z81/ Z82
Temp. R4.4 xxx °C	Current room air temperature Input Z91/ Z92
Temp. R1.4 xxx °C	Current evaporator temperature Input Z01/ Z02

- Menu 1-2 Cooling Zone 1

COOLING 1 Pos: XXXXX	
Cooling xxx	Current ON/OFF status of cooling
Run Time xx %	Cooling relay on time during last day (00:00 - 24:00 hours)
Starts 0	Cooling relay actuations during last day
Temp. R4.1 xxx °C	Current room air temperature Input Z21/Z22
Setpoint R4.1 xxx °C	Supply air temperature setpoint for comparison

Eckelmann

COOLING 1 Pos: XXXXX	
Hystersis R4.1 xxx K	Supply air temperature hysteresis setpoint

- Menu 1-3 Defrost Zone 1

DEFROST 1 Pos: XXXXX	
Defrost	Current ON/OFF status of defrosting
Temp. R1.1 XXX °C	Current supply air temperature Input Z31/Z32
Temp. R1.2 XXX °C	Current supply air temperature Input Z51/Z52
Def. End. Tmp. XXX °C	Defrost termination temperature for comparison
Wait Time xx m	Waiting time setpoint
Drip Time xx m	Drain time setpoint
2.Defrst Level XX °C	Current evaporator temperature for the 2nd defrost level (one zone operation only)
Last Defrst XX hh:mm	Day and time of last defrost cycle started
M/S Nof. Sl.	Number of parameterised and accessible MA slaves
M/S Lost Sl.	CAN address of the first MA slave which was not accessible during the last defrost
M/S Defr.Sl.	Number of slaves currently undergoing a defrost
M/S DSIMat	List of MA slaves currently undergoing a defrost (can be scrolled through using ENTER)
DSq Nof. Sl.	Number of DS slaves (only in the case of DS master)
DSq Lost Sl.	CAN address of the first FA slave which was not accessible during the last defrost
DSq Defr.Sl.	Number of slaves currently undergoing defrost
DSq DSIMat	List of FA slaves currently undergoing a defrost (can be scrolled through using ENTER)

- Menu 1-4 Evap. fan Zone 1

FANS 1 Pos: XXXXX	
FANS	Fan ON/OFF
Temp. R1.1	Evaporator temperature Input Z31/Z32
Fan Overrun	Fan overrun
Overrun Time	Overrun time

- Menu 1-5 Alarm

ALARM Pos: XXXXX	
Alarm Relay XXX	Current ON/OFF status of alarm output Terminal 15/16/18
Hi Temp Setp.1 XX °C	High temperature setpoint Zone 1
Lo Temp Setp.1 XX K	Low temperature setpoint Zone 1
Hi Temp Setp.2 XX °C	High temperature setpoint Zone 2; Only shown when two-zone operation is set (Menu 6-1)
Lo Temp Setp.2 XX K	Low temperature setpoint Zone 2; Only shown when two-zone operation is set (Menu 6-1)
Cold-room Door1 xxx	Cold-room door 1 CLS/OPN
Cold-room Door2 xxx	Cold-room door 2 CLS/OPN

- Menu 1-6 Frame Heater

MODE XXXXX	
Frame Heater xxx	Current ON/OFF status of frame heater output Terminal 91/92/93
Run Time xxx %	Current on time of frame heater
Humidity xxx %	Current ambient air humidity (transmitted via CAN bus from pack controller with fitted ambient humidity sensor)
Room temp xx °C	Current ambient air temperature (transmitted via CAN bus from pack controller with fitted ambient temperature sensor)

- Menu 1-7 Cooling Zone 2

COOLING 2 XXXXX	
Cooling XXX	Current ON/OFF status of cooling
Run Time XX %	Cooling relay on time during last day (00:00 - 24:00 hours)
Starts 0	Cooling relay actuations during last day
Temp. R4.3 XXX °C	Current room air temperature Input Z71/Z72
Setpoint R4.3 XXX °C	Room air temperature setpoint for comparison
Hystersis R4.3 XXX K	Room air temperature hysteresis setpoint

- Menu 1-8 Defrost Zone 2

DEFROST 2 Pos: XXXXX	
Defrost	Current ON/OFF status of defrosting
Temp. R1.3 XXX °C	Current supply air temperature Input Z81/Z82
Temp. R1.4 XXX °C	Current supply air temperature Input Z01/Z02
Def. End. Tmp. XXX °C	Defrost termination temperature for comparison
Wait Time xx m	Waiting time setpoint
Drip Time xx m	Drain time setpoint
Last Defrost XX hh:mm	Day and time of last defrost cycle started

- Menu 1-9 Fans Zone 2

FANS 2 Pos: XXXXX	
Fans	Fan ON/OFF
Temp. R1.3	Evaporator temperature Input Z81/Z82
Fan Overrun	Fan overrun
Overrun Time	Overrun time

9.7.3 Menu 2 Setpoints UR 141 NK

SETPOINTS POS: XXXXX	
1 Cooling	Menu 2-1; Special case: Move to menu 2-1-1 when single-zone operation is set (Menu 6-1) and setpoint toggle is disabled (Menu 3-3).
2 Defrost	Menu 2-2; Special case: Move to menu 2-2-1 when single-zone operation is set (Menu 6-1) and setpoint toggle is disabled (Menu 3-3).
3 FANS	Menu 2-3; Special case: Move to menu 2-3-1 when single-zone operation is set (Menu 6-1) and setpoint toggle is disabled (Menu 3-3).
4 Alarm	Menu 2-4; Special case: Move to menu 2-4-1 when single-zone operation is set (Menu 6-1) and setpoint toggle is disabled (Menu 3-3).
5 Frame Heater	Move to menu 2-5

- Menu 2-1 Cooling

COOLING POS: XXXXX	
1 Zone 1	Menu 2-1-1
2 Zone 2	Menu 2-1-2 Only shown when two-zone operation is set (Menu 6-1)
3 Zone 1A Altern.	Menu 2-1-3 Not shown when setpoint toggle is disabled (Menu 3-3)
4 Zone 2A Altern.	Menu 2-1-4 Only shown when two-zone operation is set (Menu 6-1) and setpoint toggle is not disabled (Menu 3-3)

- Menu 2-1-1 Zone 1

COOLING 1 POS: XXXXX		Entry	Default
Setpoint R4.1 XXX °C	Room air temperature setpoint	-10..30	5 °C
Hystersis R4.1 X K	Room air temperature hysteresis setpoint	1..8	2 K
HT. Cir. Setp. XXX °C	Heating circuit setpoint, only shown when single-zone operation is set (Menu 6-1)	--, -10..30	5 °C
HT. Cir. Hyst. X K	Heating circuit hysteresis, only shown when single-zone operation is set (Menu 6-1)	1..8	2 K

- Menu 2-1-2 Zone 2

COOLING 2 POS: XXXXX		Entry	Default
Setpoint R4.3 XXX °C	Room air temperature setpoint	-10..30	5 °C
Hystersis R4.3 X K	Room air temperature hysteresis setpoint	1..8	2 K

- Menu 2-1-3 Zone 1A Altern.

COOLING 1A POS: XXXXX		Entry	Default
Setpoint R4.1 XXX °C	Room air temperature setpoint	-10..30	3 °C
Hystersis R4.1 X K	Room air temperature hysteresis setpoint	1..8	1 K
HT. Cir. Setp. XXX °C	Heating circuit setpoint, only shown when single-zone operation is set (Menu 6-1)	--, -10..30	3 °C
HT. Cir. Hyst. X K	Heating circuit hysteresis, only shown when single-zone operation is set (Menu 6-1)	1..8	1 K

- Menu 2-1-4 Zone 2A Altern.

COOLING 2A POS: XXXXX		Entry	Default
Setpoint R4.3 XXX °C	Room air temperature setpoint	-10..30	3 °C
Hystersis R4.3 X K	Room air temperature hysteresis setpoint	1..8	1 K

- Menu 2-2 Defrost

DEFROST POS: XXXXX	
1 Zone 1	Menu 2-2-1
2 Zone 2	Menu 2-2-2 Only shown when two-zone operation is set (Menu 6-1)
3 Zone 1A Altern.	Menu 2-2-3 Not shown when setpoint toggle is disabled (Menu 3-3)
4 Zone 2A Altern.	Menu 2-2-4 Only shown when two-zone operation is set (Menu 6-1) and setpoint toggle is not disabled (Menu 3-3)

- Menu 2-2-1 Zone 1

DEFROST 1 POS: XXXXX		Entry	Default
Def. End. Tmp. XX °C	Defrost termination temperature setpoint	--, 0..30	5 °C
Wait Time xx m	Waiting time setpoint between cooling and defrosting	0 .. 15	0 m
Drip Time x m	Waiting time (drain time) setpoint between defrosting and cooling	0 .. 15	0 m
2.Defrst Level xx °C	Setpoint 2nd defrost stage	--, -20..30	- °C
M/S Degiv.Fct. XXX	Configuration of the defrost via CAN bus function. For details see chapter Master-Slave-Modus - Abtau-Synchronisation über CAN-Bus .	OFF, MASTR, SLAVE	OFF
M/S CAN Adr. XXX	Selection of the controller (1..99) participating in the defrost via CAN bus which is the master. "--", if this controller is itself master (Parameter <i>M/S Degiv.Fct.</i> = MASTR)	---, 1..99	-
DS-Function XXX	Configuration of the defrost sequence function (DS). For details see chapter Folgeabtauung (FA) über CAN-Bus .	OFF, MASTR, SLAVE	OFF
DS-Group XXX	Selection of which group a defrost sequence of this controller (1..99) belongs to.	---, 1..99	-
DS-Master XXX	Selection of which controller (1..99) participating in the defrost sequence is the master. "--", if this controller is itself the master (Parameter <i>DS-Function</i> = MASTR)	---, 1..99	-
DS-Wait time XXXm	Wait time for the defrost sequence	0..127	1 min

- Menu 2-2-2 Zone 2

DEFROST 2 POS: XXXXX		Entry	Default
Def. End. Tmp. XX °C	Defrost termination temperature setpoint	--, 0..30	5 °C
Wait Time xx m	Waiting time setpoint between cooling and defrosting	0 .. 15	0 m
Drip Time x m	Waiting time (drain time) setpoint between defrosting and cooling	0 .. 15	0 m

- Menu 2-2-3 Zone 1A Altern.

DEFROST 1A POS: XXXXX		Entry	Default
Def. End. Tmp. XX °C	Defrost termination temperature setpoint	--, 0..30	5 °C
Wait Time xx m	Waiting time setpoint between cooling and defrosting	0 .. 15	0 m
Drip Time x m	Waiting time (drain time) setpoint between defrosting and cooling	0 .. 15	0 m
2.Defrst Level xx °C	Setpoint 2nd defrost stage	--, -20..30	- °C

- Menu 2-2-4 Zone 2A Altern.

DEFROST 2A POS: XXXXX		Entry	Default
Def. End. Tmp. XX °C	Defrost termination temperature setpoint	--, 0..30	5 °C
Wait Time xx m	Waiting time setpoint between cooling and defrosting	0 .. 15	0 m
Drip Time x m	Waiting time (drain time) setpoint between defrosting and cooling	0 .. 15	0 m

- Menu 2-3 Fan

FANS POS: XXXXX	
1 Zone 1	Move to menu 2-3-1
2 Zone 2	Move to menu 2-3-2 Only shown when two-zone operation is set (Menu 6-1)
3 Zone 1A Altern.	Move to menu 2-3-3 Not shown when setpoint toggle is disabled (Menu 3-3)
4 Zone 2A Altern.	Move to menu 2-3-4 Only shown when two-zone operation is set (Menu 6-1) and setpoint toggle is not disabled (Menu 3-3)

- Menu 2-3-1 Zone 1

FANS 1 POS: XXXXX		Entry	Default
Fan Overrun	Setpoint fan overrun	---, -10...20	3 °C
Overrun Time	Setpoint overrun time	0..100	5 m

- Menu 2-3-2 Zone 2

FANS 2 POS: XXXXX		Entry	Default
Fan Overrun	Setpoint fan overrun	---, -10...20	3 °C
Overrun Time	Setpoint overrun time	0..100	5 m

- Menu 2-3-1 Zone 1A Altern.

FANS 1A POS: XXXXX		Entry	Default
Fan Overrun	Setpoint fan overrun	---, -10...20	3 °C
Overrun Time	Setpoint overrun time	0..100	5 m

- Menu 2-3-1 Zone 2A Altern.

FANS 2A POS: XXXXX		Entry	Default
Fan Overrun	Setpoint fan overrun	---, -10...20	3 °C
Overrun Time	Setpoint overrun time	0..100	5 m

- Menu 2-4 Alarm

ALARM POS: XXXXX	
1 Zone 1	Menu 2-4-1
2 Zone 2	Menu 2-4-2 Only shown when two-zone operation is set (Menu 6-1)
3 Zone 1A Altern.	Menu 2-4-3 Not shown when setpoint toggle is disabled (Menu 3-3)
4 Zone 2A Altern.	Menu 2-4-4 Only shown when two-zone operation is set (Menu 6-1) and setpoint toggle is not disabled (Menu 3-3)

- Menu 2-4-1 Zone 1

ALARM 1 POS: XXXXX		Entry	Default
High Temp Setp XX °C	High temperature setpoint at which <i>High Temperature</i> alarm is generated	0..30	10 °C
Low Temp Setp. XX K	Low temperature setpoint (difference below temperature control setpoint) at which <i>Low Temperature</i> alarm is generated	--, 0..6	2 K

- Menu 2-4-2 Zone 2

ALARM 2 POS: XXXXX		Entry	Default
High Temp Setp XX °C	High temperature setpoint at which <i>High Temperature</i> alarm is generated	0..30	10 °C
Low Temp Setp. XX K	Low temperature setpoint (difference below temperature control setpoint) at which <i>Low Temperature</i> alarm is generated	--, 0..6	2 K

- Menu 2-4-3 Zone 1A Altern.

ALARM 1A POS: XXXXX		Entry	Default
High Temp Setp XX °C	High temperature setpoint at which <i>High Temperature</i> alarm is generated	0..30	8 °C
Low Temp Setp. XX K	Low temperature setpoint (difference below temperature control setpoint) at which <i>Low Temperature</i> alarm is generated	--, 0..6	2 K

- Menu 2-4-4 Zone 2A Altern.

ALARM 2A POS: XXXXX		Entry	Default
High Temp Setp XX °C	High temperature setpoint at which <i>High Temperature</i> alarm is generated	0..30	8 °C
Low Temp Setp. XX K	Low temperature setpoint (difference below temperature control setpoint) at which <i>Low Temperature</i> alarm is generated	--, 0..6	2 K

- Menu 2-5 Frame Heater

FRAME HTR POS: XXXXX	
1 Mode altern.	Move to menu 2-5-1
2 Setpoint frm htr	Move to menu 2-5-2
3 Mode altern.	Move to menu 2-5-3 Not shown when setpoint toggle is disabled (Menu 3-3)
4 Setpoint altern.	Move to menu 2-5-4 Not shown when setpoint toggle is disabled (Menu 3-3)

- Menu 2-5-1 Mode altern.

Select between values. Checkmark shows current setting.

MODE POS: XXXXX		Entry	Default
fixed run time ✓	Fixed frame heater on time	↵	✓
enthalpy-ctrl rtm	Enthalpy control by ambient air temperature and humidity	↵	

- Menu 2-5-2 Setpoint frame heater

SETPOINTS POS: XXXXX		Entry	Default
Mod: xxxxxxxxxxxx	Displays set frame heater mode (Menu 2-5-1)		Fixed on time
Run Time XXX %	Fixed on time, Only shown when mode set to Fixed On Time (Menu 2-5-1)	--, 0..100	100 %
emerg.run time XXX %	On time in failure of ambient air humidity or temperature signal (via CAN bus) Only shown when mode set to Enthalpy Control (Menu 2-5-1)	--, 0..100	100 %
enthalp. offs. XXX %	Offset to on time with activated enthalpy control (via CAN bus) Only shown when mode set to Enthalpy Control (Menu 2-5-1)	-50..50	0 %
Invert Output xxx	Inversion of the function of the frame heater output (terminal 91/92)	↑, ↓, (ON/OFF)	ON

- Menu 2-5-3 Mode altern.

Select between values. Checkmark shows current setting.

MODE ALT POS: XXXXX		Entry	Default
fixed run time ✓	Fixed frame heater on time	↵	✓
enthalpy-ctrl rtm	Enthalpy control by ambient air temperature and humidity	↵	

- Menu 2-5-4 Setpoint altern.

SOLLW. UM POS: XXXXX		Entry	Default
Mod: xxxxxxxxxxxx	Displays set frame heater mode (Menu 2-5-3)		Fixed on time
Run Time XXX %	Fixed on time, Only shown when mode set to Fixed On Time (Menu 2-5-3)	--, 0..100	100 %
emerg.run time XXX %	On time in failure of ambient air humidity or temperature signal (via CAN bus) Only shown when mode set to Enthalpy Control (Menu 2-5-3)	--, 0..100	100 %

Eckelmann

SOLLW. UM POS: XXXXX		Entry	Default
enthalp. offs. XXX %	Offset to on time with activated enthalpy control (via CAN bus) Only shown when mode set to Enthalpy Control (Menu 2-5-3)	-50..50	0 %

9.7.4 Menu 3 Clock UR 141 NK

CLOCK POS: XXXXX	
1 Current Time	Move to menu 3-1
2 Defrost timer	Move to menu 3-2
3 Toggle Setpoints	Move to menu 3-3

- Menu 3-1 Current Time



 Time is defined by time master (system centre / store computer / operator terminal) when CAN bus is connected. Any entry made will then be overwritten by the defined value.

CLOCK POS: XXXXX		Entry	Default
Date: XX dd.mm.yy	Display and enter current weekday, date	dd.mm.yy	
Time: hh.mm	Display and enter current time	hh.mm	
Daylight Saving X	Display and enter automatic daylight saving change (Y/N)	↑, ↓, (Y/N)	J

- Menu 3-2 Defrost timer

DERF. TIMER POS: XXXXX		Entry	Default
Defrost timer XXX	Defrost initiation via input D11/12 (EXT) or internal (INT)	↑, ↓, (EXT, INT)	INT
Safe Defr Time XXX m	Safe defrost time for maximum allowed duration of defrosting (used only for internal defrosting)	0..180	90 min
Manual Defrost XXX	Status (OFF/ON) for supplementary manual defrosting *) shown only when parameter defrost timer = INT	↑, ↓, (ON/OFF)	OFF
Def.Tim.Z2	Separate defrost timer for zone 2	Menu 3-2-a	
Defr. 1 xxxxx hh:mm	Defrost start time with internal defrosting; Weekday, time; shown only when parameter defrost timer = INT	↑, ↓, (Mo-Su etc.) or numbers (hh:mm)	Mo-Su01:00
Defr. 2 xxxxx hh:mm	Defrost start time with internal defrosting; Weekday, time; shown only when parameter defrost timer = INT	↑, ↓, (Mo-Su etc.) or numbers (hh:mm)	Mo-Su06:00
Defr. 3 xxxxx hh:mm	Defrost start time with internal defrosting; Weekday, time; shown only when parameter defrost timer = INT	↑, ↓, (Mo-Su etc.) or numbers (hh:mm)	Mo-Su13:00

Eckelmann





DERF. TIMER POS: XXXXX		Entry	Default
Defr. 4 xxxxx hh:mm	Defrost start time with internal defrosting; Weekday, time; shown only when parameter defrost timer = INT	  , (Mo-Su etc.) or numbers (hh:mm)	Mo-Su21:00
...			
Defr. 14 xxxxx hh:mm	Defrost start time with internal defrosting; Weekday, time; shown only when parameter defrost timer = INT		

 *) Parameter automatically set to ON for safe defrost time at first start.

• Menu 3-2-a Def.Tim.Z2

DEFR.TIMER POS: XXXXX		Entry	Default
Defrost Timer XXX	Setting for how temperature zone 2 should defrost: <ul style="list-style-type: none"> • With Z1 Together with zone 1 • INT Internally • EXT Externally – the defrost of both temperature zones is started simultaneously via the external signal 	↑ , ↓ , (ViaZ1, ViaZ1,EXT,INT)	ViatZ1
Safe Defr Time XXX m	Safe defrost time, i.e. max. allowed duration of defrosting (internal defrost only)	0..120	60 min
Manual Defrost XXX	Status (ON/OFF) of auxiliary manual defrost *)	↑ , ↓ , (ON/OFF)	OFF
Defr. 1 xxxxx hh:mm	Defrost start time for internal defrost; weekday, time of day; shown only when parameter <i>defrost timer</i> = INT	↑ , ↓ , (Mo-Su) or numbers (hh:mm)	Mo-Su 01:00
...			
Defr. 14 xxxxx hh:mm			

• Menu 3-3 Toggle Setpoints

TOGGLE POS: XXXXX		Entry	Default
Status XXX	Setpoint toggle status (OFF/ON) of alternative set of setpoints (setpoint toggle)		
Toggle Setp. XXX	Setpoint toggle via <ul style="list-style-type: none"> • EXT digital input D21/22 • INT internal timer • CAN bus- „--“ deactivated Note: Care should be taken that the corresponding digital input D21/D22 is set to SOLLW.UMSCH (menu 6-2-4)	 , (EXT, INT, CAN, --)	EXT
Alt ON: DD-DD hh:mm	Start time for toggle to alternative set of setpoints Weekday from - to XXXXX, time hh:mm Only shown when internal setpoint toggle is activated (Menu 3-3)	 , (Mo-Su etc.) or numbers (hh:mm)	Mo-Su 21:00
AltOFF: DD-DD hh:mm	End time for toggle to alternative set of setpoints Weekday from - to XXXXX, time hh:mm Only shown when internal setpoint toggle is activated (Menu 3-3)	 , (Mo-Su etc.) or numbers (hh:mm)	Mo-Su 05:00
Alt ON: DD-DD hh:mm	Start time for toggle to alternative set of setpoints Weekday from - to XXXXX, time hh:mm Only shown when internal setpoint toggle is activated (Menu 3-3)	 , (Mo-Su etc.) or numbers (hh:mm)	Su 05:00
AltOFF: DD-DD hh:mm	End time for toggle to alternative set of setpoints Weekday from - to XXXXX, time hh:mm Only shown when internal setpoint toggle is activated (Menu 3-3)	 , (Mo-Su etc.) or numbers (hh:mm)	Su 21:00
...	A total of 7 different ON and OFF toggle times can be defined. A toggle time will only be obeyed when a <u>matched pair</u> of on and off times is set as a parameter.		

9.7.5 Menu 4 Messages UR 141 NK

MESSAGES POS: XXXXX	
1 View	Move to menu 4-1: Show Message Log
2 Acknowledge	Messages in message log are cancelled. <i>"Alarms Cancelled!"</i> shown in display: Press ESC to go back.
3 Delete	Move to menu 4-2: Delete Message Log (with prompt)

- Menu 4-1 View Messages

MESSAGES POS: XXXXX	
Error Message 1:	Fault 1 message text
dd.mm.yy hh:mm ON	Start of Fault 1
dd.mm.yy hh:mm OFF	End of Fault 1 (only when Fault 1 terminated)
...	
Error Message n:	Fault n message text
dd.mm.yy hh:mm ON	Start of Fault n
dd.mm.yy hh:mm OFF	End of Fault n (only when Fault n terminated)

- Menu 4-2 Acknowledge Messages
This displays the *"Alarms Cancelled!"* message.
- Menu 4-3 Delete Messages

MESSAGES POS: XXXXX		Entry
Delete! Are you sure? No: ESC YES: ↵	Safety prompt for deleting messages Press ESC to go back after cancelling messages.	↵, ESC

9.7.6 Menu 5 Archive UR 141 NK

ARCHIVE POS: XXXXX	
dd.mm.yy hh:mm	Time of archiving Record 1
Zone 1: abcdef x °C	Status and temperature of Zone 1, see Note
Zone 2: abcdef x °C	Status and temperature of Zone 2, see Note Only shown when two-zone operation is set (Menu 6-1)
...	
dd.mm.yy hh:mm	Time of archiving Record n
Zone 1: abcdef x °C	Status and temperature of Zone 1, see Note
Zone 2: abcdef x °C	Status and temperature of Zone 2, see Note Only shown when two-zone operation is set (Menu 6-1)

 *) Status abcdef covers following states of refrigeration point. The entry at this position is - when a state is not active. Example Zone 1: abcdef x °C

	Single-zone operation resp. Operator interface BT 300	Two-zone operation
a	O = Operation	O = Operation
b	R = Refrigeration / Cooling	R = Refrigeration / Cooling
c	R = Refrigeration/ Cooling	D = Defrost
d	D = Defrost	G = Gate / Door (cold-room controller only)
e	G = Gate / Door (cold-room controller only)	A = Alarm
f	A = Alarm	

9.7.7 Menu 6 Configuration UR 141 NK

CONFIGURAT POS: XXXXX	
1 Refriger. Point	Move to menu 6-1
2 Controller	Move to menu 6-2
3 Cooling	Move to menu 6-3
4 Language	Move to menu 6-4
5 Alarm priorities	Move to menu 6-5
6 Em.Powersupply	Move to menu 6-6
7 Enhanced	Move to menu 6-7

- Menu 6-1 Refriger. Point

REFR. PT. POS: XXXXX		Entry	Default
Refr. Pt. Name:	Text only		
xxxxxxxxxxxxxxxx	Free text entry describing refrigeration point (see note)		Kühlstellenregler
Item ID: XXXXX	Free text entry displayed in screens after ITEM ID (see note)		UA400
Priority: XX	Alarm priority in failure of refrigeration point or when global controller priority is set (Menu 6-5)	↑, ↓, or numbers (0..99)	1
Refr. Sys. No.: XX	No. of pack controller allocated to case/cold-room controller	↑, ↓, or numbers (--, 1..9)	1
Refr. Sys. Type XXX	Associated compressor pack. Parameter only required when linked to a VS 3010 BS having several zones. If a different type of pack controller is used, set this parameter blank (---)	↑, ↓, or numbers (---, Z1, Z2)	—
Temp. Zones X	Number of temperature zones Single-zone operation Two-zone operation	↑, ↓, or numbers (1, 2)	2
No. Sensors XX	Number of temperature sensors connected. After entering ↵ sensor scan is performed to redetermine the number of sensorium of sensors	↵	

⚠ The priority must be assigned between 0..2 by older versions of the store computer (<V5.0), see chapter [Alarms and Messages of UA 400](#).

- ① A meaningful name that describes the refrigeration point in more detail should be entered, e.g. Cheese Counter 2 and CC2. Entry is made in the screens on system centre, store computer or operator terminal. Direct entry cannot be made in the controller screens displayed on the operator terminal. Entry cannot be made either on operator interface BT 300.

- Menu 6-2 Controller

CONTROLLER POS: XXXXX	
1 Type and Version	Move to menu 6-2-1
2 Temp. Display	Move to menu 6-2-2
3 Alarm Delay	Move to menu 6-2-3
4 230V Inputs	Move to menu 6-2-4
5 Sensor Type	Move to menu 6-2-5

- Menu 6-2-1 Type and Version

VERSION POS: XXXXX		Entry	Default
Ctrlr. Type XXXXXXXX	Controller type set by DIP Switch S3	–	UR141NK
Software Ver.: XXXX	Software version of case/cold-room controller	–	x.yy
Serial No.: XXXXXXX	Device No. of case/cold-room controller	–	
Master/Sl. Mode XXX	Synchronized defrosting in master-slave mode (ON/OFF)	–	

- Menu 6-2-2 Temp. Display

DISPLAY POS: XXXXX		Entry	Default
Offset XX K	Offset for temperature display	-10..10	0K
Alarm symbol X	Show alarm symbol on BT 30 Temperature Display	↑, ↓, (Y/N)	N

- Menu 6-2-3 Alarm Delay

ALARMDELAY POS: XXXXX		Entry	Default
Sensor Fault XX m	Sensor break alarm delay	0..30	15 min
High/Low Temp. XX m	High/low temperature alarm delay	0..150	90 min
Door open XX m	Cold-room door open alarm delay	0 .. 60	60 m
No Defrost XX h	No defrost alarm delay	--, 2..168	30 h
Selfholding X	NO: Automatic reset of non- transient alarms. YES: Alarms must be reset manually.	↑, ↓, (Y/N)	N

- Menu 6-2-4 230V Inputs

 Only trained personnel should be allowed to change inputs, as changes may affect other functions.

230V INPUT POS: XXXXX		Entry	Default
Entry1: XXXXXXXXXX	Function of digital input 1 D11/D12	1)	DEFR.TIMER
Entry2: XXXXXXXXXX	Function of digital input 2 D21/D22	2)	DOOR CONTACT
Entry3: XXXXXXXXXX	Function of digital input 3 D31/D32	3)	DOOR CONTACT
Entry4: XXXXXXXXXX	Function of digital input 4 D41/D42	4)	Extern.Alarm
XXXXXXXXXXXXXXXXXXXX	Freely configurable alarm text for digital input 4, the default text is "CO2-Alarm"	Text	CO2-ALARM
Inv. D1 XXX	Inverting of digital input 1	↑, ↓, (ON/OFF)	OFF
Inv. D2 XXX	Inverting of digital input 2		OFF
Inv. D3 XXX	Inverting of digital input 3		OFF
Inv. D4 XXX	Inverting of digital input 4		OFF

Possible settings for the digital inputs:

1. DEFR.TIMER Defrost timer*
 MANUAL OFF. Manual shutoff both zones
 MANUAL OFF. Z1 Manual shutoff only Z1
 MANUAL OFF. Z2 Manual shutoff only Z2
 TOGGLE SETP. Toggle setpoint
2. DOOR CONTACT Door contact 2 *
 MANUAL OFF Manual shutoff both zones
 MANUAL OFF. Z1 Manual shutoff only Z1
 MANUAL OFF. Z2 Manual shutoff only Z2
 TOGGLE SETP Toggle setpoint
3. DOOR CONTACT Door contact 1 *
 MANUAL OFF Manual shutoff both zones *
 MANUAL OFF. Z1 Manual shutoff only Z1
 MANUAL OFF. Z2 Manual shutoff only Z2
4. EXT ALARM External Alarm *
 MANUAL OFF Manual shutoff both zones
 MANUAL OFF. Z1 Manual shutoff only Z1
 MANUAL OFF. Z2 Manual shutoff only Z2
 TOGGLE SETP Toggle setpoint

*Factory setting

Eckelmann

- Menu 6-2-5 Sensor Type

Select between values. Checkmark shows current setting.

SENSORS POS: XXXXX		Entry	Default
L243 ✓	Temperature range -50..50°C	↩	✓
K277	Temperature range -50..50°C	↩	
5K3A1	Temperature range 0..100°C	↩	

- Menu 6-3 Cooling

COOLING POS: XXXXX		Entry	Default
Min. On Time XX K	Minimum cooling ON time	0..15	2 m
Min. Off Time XX m	Minimum cooling OFF time	0..15	2 m
Emergency Op. xx m	In failure of required sensors, the solenoid valve is actuated to adjust to the set opening in %.	0..100	30%

- Menu 6-4 Language

LANGUAGE POS: XXXXX	Entry	Default
Deutsch D ✓	↩	✓
English GB	↩	
Francais F	↩	
Espagnol E	↩	
Finnish FIN	↩	
Türkce TR	↩	
Cesky CZ	↩	

- Menu 6-5 Alarm priorities

ALARMPRIOS POS: XXXXX		Entry	Default
Prio.Refrig. Pt. X	Global alarm priority by refrigeration point priority (Menu 6-1) (Y)	↑, ↓, (Y,N)	N
Priority: XX	Show refrigeration point priority (Menu 6-1) Only shown when refrigeration point priority set to Y.		
<i>Following parameters are only shown when refrigeration point priority is set to N. Meaning of usable entries for alarm priority: -=Event ignored 0=Message (entered only in message log) 1=Priority 1 alarm..99=Priority 99 alarm</i>			
Low Temp.	Temperature below lower alarm limit Priority applies to following alarms: Low Temp. Zone1, Low Temp. Zone2	-, 0..99	2
High Temp.	Temperature above upper alarm limit Priority applies to following alarms: High Temp. Zone1, High Temp. Zone2	-, 0..99	1
Sensor Fault	Temperature sensor failure	-, 0..99	2
Door Open	Cold-room door open	-, 0..99	2
No Defrost	No defrost within alarm delay interval Priority applies to following alarm: No defrost	-, 0..99	1
Timer-Term.Defr.	Defrosting terminated by safe defrost time	-, 0..99	0
Power Failure	Start following power failure	-, 0..99	0
First Start	Controller start up (basic settings loaded!)	-, 0..99	2

ALARMPRIOS POS: XXXXX		Entry	Default
Manual Shutoff	Manual switch Input D31/D32 set OFF	-, 0..99	0
Hardware Fault	Internal hardware fault Priority applies to following alarms: EEPROM Fault, RTC Fault, Flash Fault	-, 0..99	1
Setpoint Change	Message generated on changing setpoint	0..99	0
Refrig.Pt.Dis.	Cooling by pack controller via CAN bus interrupted	-, 0..99	0
Battery Voltage	Battery low	-, 0..99	0

- Menu 6-6 Em.Powersupply (Emergency Power supply)

EM.POW.SUP POS: XXXXX		Entry	Default
Cool.funct.OFF xxx	Functionality of the cooling switched off during emergency power supply? (Y/N)	↑ , ↓ , (Y/N)	N
Defr.funct.OFF xxx	Functionality of the defrosting switched off during emergency power supply? (Y/N)	↑ , ↓ , (Y/N)	N
Fan funct. OFF xxx	Functionality of the fan switched off during emergency power supply? (Y/N)	↑ , ↓ , (Y/N)	N
Frame fct.OFF xxx	Functionality of the frame heater off during emergency power supply? (Y/N)	↑ , ↓ , (Y/N)	N
Light fct. OFF xxx	Functionality of the light during emergency power supply? (Y/N)	↑ , ↓ , (Y/N)	N

- Menu 6-7 Enhanced

ENHANCED POS: XXXXX	
1 SDS TEV	Move to menu 6-7-1
2 Service Mode	Move to menu 6-7-2

- Menu 6-7-1 SDS TEV

SDS TEV POS: XXXXX		Entry	Default
SDS TEV xx m	Principle participation of the controller in the suction pressure shift. (function COPT+). Note: This is transmitted via a CAN bus telegram and intervenes in the regulation!	↑ , ↓ , (ON/OFF)	OFF
Inact.a.Def xx m	Delay time following completion of the defrost before the controller actively intervenes in the shift.	0..40	30 min,
Dely_HystON xxxxm	Delay time for the reduction request with active cooling and overshoot of the hysteresis.	0..10	2.5 min
HiTmpZ1 dwn xxm	Delay time before the elapse of the high temperature alarm delay in zone 1, before the reduction is requested.	0..15	5 min.
HiTmpZ2 dwn xxm	Delay time before the elapse of the high temperature alarm delay in zone 2, before the reduction is requested.	0..15	5 min.
ToOvHystZ1 xxK	Tolerance limit above the setpoint plus hysteresis in zone 1. Influences when it is switched from stop to reduce.	0..20	2 K
ToOvHystZ2 xxK	Tolerance limit above the setpoint plus hysteresis in zone 2. Influences when it is switched from stop to reduce.	0..20	2 K
SwchSupRet xxx	Switching from supply air to return air and the reverse with temperature alarm delay time.	↑ , ↓ , (ON/OFF)	OFF
Dely_Switch xxxm	Switching from supply to return air: determines when it is switched within the delay time for the high temperature alarm.	0..15	5 min.
Add.Values xxx	Creation of additional (additive) "Debug" actual value archives in the system centre / store computer. Warning: This can force a reorganisation of the actual value archives – for this reason only use when required!	↑ , ↓ , (ON/OFF)	OFF
Incl_UpLim xxxK	Upper limit of the neutral zone for determining the incline.	0..5	0.3 K
Incl_LwLim xxxK	Lower limit of the neutral zone for determining the incline.	0..5	0.2 K

- Menu 6-7-2 Service Mode

SERVICIE MOD POS: XXXXX		Entry	Default
Relay 1 x	Relay 1 (terminal 15/16/18) switch on or off (1 or 0)	0 / 1	0
Relay 2 x	Relay 2 (terminal 25/26/28) switch on or off (1 or 0)	0 / 1	0
Relay 3 x	Relay 3 (terminal 35/36/38) switch on or off (1 or 0)	0 / 1	0
Relay 4 x	Relay 4 (terminal 43/44) switch on or off (1 or 0)	0 / 1	0
Relay 5 x	Relay 5 (terminal 53/54) switch on or off (1 or 0)	0 / 1	0
Relay 6 x	Relay 6 (terminal 64/65) switch on or off (1 or 0)	0 / 1	0
Relay 7 x	Relay 7 (terminal 73/74) switch on or off (1 or 0)	0 / 1	0
24V Out 1 x	Transistor output 1 (terminal 81/82) switch on or off (24 VDC / 50 mA)	0 / 1	0
24V Out 2 x	Transistor output 2 (terminal 91/92) switch on or off (24 VDC / 50 mA)	0 / 1	0
ANA OUT 1 xxxV	Analog output 1 (terminal 29/30) Default 0..10 VDC	0..10	0.0V
ANA OUT 2 xxxV	Analog output 2 (terminal 31/32) Default 0..10 VDC	0..10	0.0V
ANA IN 1 xxmA	Power analog input 1 (terminal 11/12) 4..20 mA	4..20	mA
ANA IN 2 xxmA	Power analog input 2 (terminal 11/14) 4..20 mA	4..20	mA
InputD 1 xxx	Status digital input 1 ON = 230 V AC voltage connected OFF = no voltage present	ON/OFF	-
InputD 2 xxx	Status digital input 2 ON = 230 V AC voltage connected OFF = no voltage present	ON/OFF	-
InputD 3 xxx	Status digital input 3 ON = 230 V AC voltage connected OFF = no voltage present	ON/OFF	-
InputD 4 xxx	Status digital input 4 ON = 230 V AC voltage connected OFF = no voltage present	ON/OFF	-

9.8 Controller type UA 141 TK - menu tree

DIP switch S3	UR 141 TK
	1: ON 2: OFF 3: ON 4: ON/OFF = Master / Slave mode ON/OFF 5..8: OFF 9: ON

Main menu	Submenu	Submenu 2	Menu number	Menu name
			0	REFRIGERATION POINT
Actual values			1	ACTUAL VALUES
	Temperature sensor		1-1	TEMPERATURE
	Cooling Zone 1		1-2	COOLING 1
	Defrost Zone 1		1-3	DEFROST 1
	Fans Zone 1		1-4	FAN 1
	Alarm		1-5	ALARM
	Frame heater		1-6	FRAME HEATER
	Cooling Zone 2		1-7	COOLING 2
	Defrost Zone 2		1-8	DEFROST 2
	Fans Zone 2		1-9	FAN 2
Setpoints			2	SETPOINTS
	Cooling		2-1	COOLING
		Zone 1	2-1-1	COOLING 1
		Zone 2	2-1-2	COOLING 2
		Zone 1 U Umschalt.	2-1-3	COOLING 1U
		Zone 2 U Umschalt.	2-1-4	COOLING 2U
	Defrost		2-2	DEFROST
		Zone 1	2-2-1	DEFROST 1
		Zone 2	2-2-2	DEFROST 2
		Zone 1 U Umschalt.	2-2-3	DEFROST 1U
		Zone 2 U Umschalt.	2-2-4	DEFROST 2U
	Condenser Fans		2-3	CONDENSER FANS

		Zone 1	2-3-1	FAN 1
		Zone 2	2-3-2	FAN 2
		Zone 1 U Umschalt.	2-3-3	LÜFTER 1U
		Zone 2 U Umschalt.	2-3-4	LÜFTER 2U
	Alarm		2-4	ALARM
		Zone 1	2-4-1	ALARM 1
		Zone 2	2-4-2	ALARM 2
		Zone 1 U Umschalt.	2-4-3	ALARM 1U
		Zone 2 U Umschalt.	2-4-4	ALARM 2U
	Frame heater		2-5	RAHMENHEIZ
		Frame heater mode	2-5-1	FRAME HEATER
		Frame heater setpoints	2-5-2	SETPOINTS
		Toggle mode	2-5-3	RAHMEN UM.
		Toggle setpoints	2-5-4	SOLLW. UM.
Clock			3	CLOCK
	current time		3-1	CLOCK
	Defrost timer		3-2	DEFROST TIMER
		Abt.Uhr Z2	3-2-a	ABT.UHR Z2
	Toggle setpoints		3-3	UMSCHALTNG
Messages			4	MESSAGES
	view		4-1	MESSAGES
	acknowledge		4-2	
	delete		4-3	MESSAGES
Archive			5	ARCHIVE
Configuration			6	KONFIGURAT
	Refrigeration point		6-1	REFRIGERATION POINT
	Controller		6-2	CONTROLLER
		Type and version	6-2-1	VERSION
		Temperature display	6-2-2	DISPLAY

	Alarm delay	6-2-3	ALARMVERZ.
	230 V inputs	6-2-4	230 V INPUTS
	Sensor type	6-2-5	SENSOR TYPE
Cooling		6-3	COOLING
Language		6-4	LANGUAGE
Alarm priorities		6-5	ALARMPRIOS
Emergency power operation		6-6	NOTNETZ
Advanced		6-7	ADVANCED
	SDS TEV	6-7-1	SDS TEV
	Service Mode	6-7-2	SERVICE MOD

9.8.1 Main menu UR 141 TK

REFR. PT. POS: XXXXX	
1 Actual Values	Move to menu 1
2 Setpoints	Move to menu 2
3 Clock	Move to menu 3
4 Messages	Move to menu 4
5 Archive	Move to menu 5
6 Configuration	Move to menu 6

9.8.2 Menu 1 Actual Values UR 141 TK

ACT VALUES POS: XXXXX	
1 Temp. Sensor	Move to menu 1-1
2 Cooling Zone 1	Move to menu 1-2
3 Defrost Zone 1	Move to menu 1-3
4 Evap. fan Zone 1	Move to menu 1-4
5 Alarm	Move to menu 1-5
6 Frame Heater	Move to menu 1-6
7 Cooling Zone 2	Move to menu 1-7 Only shown when two-zone operation is set (Menu 6-1)
8 Defrost Zone 2	Move to menu 1-8 Only shown when two-zone operation is set (Menu 6-1)
9 FANS Zone 2	Move to menu 1-9 Only shown when two-zone operation is set (Menu 6-1)

- Menu 1-1 Temp. Sensor

TEMPERATUR Pos: XXXXX	
Temp. R4.1 xxx °C	Current room air temperature Input Z21/ Z22
Temp. R1.1 xxx °C	Current evaporator defrost termination temperature Input Z31/ Z32
Temp. R4.2 xxx °C	Current room air temperature Input Z41/ Z42
Temp. R1.2 xxx °C	Current evaporator defrost termination temperature Input Z51/ Z52
Temp. R4.3 xxx °C	Current room air temperature Input Z71/ Z72
Temp. R1.3 xxx °C	Current evaporator defrost termination temperature Input Z81/ Z82
Temp. R4.4 xxx °C	Current room air temperature Input Z91/ Z92
Temp. R1.4 xxx °C	Current evaporator defrost termination temperature Input Z01/ Z02

- Menu 1-2 Cooling Zone 1

COOLING 1 Pos: XXXXX	
Cooling xxx	Current ON/OFF status of cooling
Run Time xx %	Cooling relay on time during last day (00:00 - 24:00 hours)
Starts 0	Cooling relay actuations during last day
Temp. R4.1 xxx °C	Current room air temperature Input Z21/Z22
Setpoint R4.1 xxx °C	Supply air temperature setpoint for comparison

Eckelmann

COOLING 1 Pos: XXXXX	
Hystersis R4.1 xxx K	Supply air temperature hysteresis setpoint

- Menu 1-3 Defrost Zone 1

DEFROST 1 Pos: XXXXX	
Counting Rate	Counting rate
Defrost Counter	Defrost counter
Defrost	Current ON/OFF status of defrosting
Temp. R1.1 XXX °C	Current supply air temperature Input Z31/Z32
Temp. R1.2 XXX °C	Current supply air temperature Input Z51/Z52
Def. End. Tmp. XXX °C	Defrost termination temperature for comparison
Wait Time xx m	Waiting time setpoint
Drip Time xx m	Drain time setpoint
2.Defrst Level XX °C	Current evaporator temperature for the 2nd defrost level (one zone operation only)
Last Defrst XX hh:mm	Day and time of last defrost cycle started
M/S Nof. Sl.	Number of parameterised and accessible MA slaves
M/S Lost Sl.	CAN address of the first MA slave which was not accessible during the last defrost
M/S Deifr.Sl.	Number of slaves currently undergoing a defrost
M/S DSIMat	List of MA slaves currently undergoing a defrost (can be scrolled through using ENTER)
DSq Nof. Sl.	Number of DS slaves (only in the case of DS master)
DSq Lost Sl.	CAN address of the first FA slave which was not accessible during the last defrost
DSq Deifr.Sl.	Number of slaves currently undergoing defrost
DSq DSIMat	List of FA slaves currently undergoing a defrost (can be scrolled through using ENTER)

- Menu 1-4 Evap. fan Zone 1

FANS 1 Pos: XXXXX	
FANS	Fan ON/OFF
Temp. R1.1	Evaporator temperature Input Z31/Z32
Fan Delay	Fan delay

- Menu 1-5 Alarm

ALARM Pos: XXXXX	
Alarm Relay XXX	Current ON/OFF status of alarm output Terminal 15/16/18

Eckelmann

ALARM Pos: XXXXX	
Hi Temp Setp.1 XX °C	High temperature setpoint Zone 1
Lo Temp Setp.1 XX K	Low temperature setpoint Zone 1
Hi Temp Setp.2 XX °C	High temperature setpoint Zone 2;Only shown when two-zone operation is set (Menu 6-1)
Lo Temp Setp.2 XX K	Low temperature setpoint Zone 2;Only shown when two-zone operation is set (Menu 6-1)
Cold-room Door CLS1 xxx	Cold-room door 1 OPEN/CLOSED
Cold-room Door CLS2 xxx	Cold-room door 2 OPEN/CLOSED

- Menu 1-6 Frame Heater

MODE XXXXX	
Frame Heater xxx	Current ON/OFF status of frame heater output Terminal 91/92/93
Run Time xxx %	Current on time of frame heater
Humidity xxx %	Current ambient air humidity (transmitted via CAN bus from pack controller with fitted ambient humidity sensor)
Room temp xx °C	Current ambient air temperature (transmitted via CAN bus from pack controller with fitted ambient temperature sensor)

- Menu 1-7 Cooling Zone 2

COOLING 2 XXXXX	
Cooling XXX	Current ON/OFF status of cooling
Run Time XX %	Cooling relay on time during last day (00:00 - 24:00 hours)
Starts 0	Cooling relay actuations during last day
Temp. R4.3 XXX °C	Current room air temperature Input Z71/Z72
Setpoint R4.3 XXX °C	Room air temperature setpoint for comparison
Hysteresis R4.3 XXX K	Room air temperature hysteresis setpoint

- Menu 1-8 Defrost Zone 2

DEFROST 2 Pos: XXXXX	
Counting Rate	Counting rate
Defrost Counter	Defrost counter
Defrost	Current ON/OFF status of defrosting
Temp. R1.3 XXX °C	Current supply air temperature Input Z81/Z82
Temp. R1.4 XXX °C	Current supply air temperature Input Z01/Z02
Def. End. Tmp. XXX °C	Defrost termination temperature for comparison
Wait Time xx m	Waiting time setpoint
Drip Time xx m	Drain time setpoint
Last Defrost XX hh:mm	Day and time of last defrost cycle started

- Menu 1-9 Fans Zone 2

FANS 2 Pos: XXXXX	
FANS	Fan ON/OFF
Temp. R1.3	Evaporator temperature Input Z81/Z82

Eckelmann

FANS 2 Pos: XXXXX	
Fan Delay	Fan delay

9.8.3 Menu 2 Setpoints UR 141 TK

SETPOINTS POS: XXXXX	
1 Cooling	Menu 2-1; Special case: Move to menu 2-1-1 when single-zone operation is set (Menu 6-1) and setpoint toggle is disabled (Menu 3-3).
2 Defrost	Menu 2-2; Special case: Move to menu 2-2-1 when single-zone operation is set (Menu 6-1) and setpoint toggle is disabled (Menu 3-3).
3 FANS	Move to menu 2-3; Special case: Move to menu 2-3-1 when single-zone operation is set (Menu 6-1) and setpoint toggle is disabled (Menu 3-3).
4 Alarm	Menu 2-4; Special case: Move to menu 2-4-1 when single-zone operation is set (Menu 6-1) and setpoint toggle is disabled (Menu 3-3).
5 Frame Heater	Move to menu 2-5

- Menu 2-1 Cooling

COOLING POS: XXXXX	
1 Zone 1	Menu 2-1-1
2 Zone 2	Menu 2-1-2 Only shown when two-zone operation is set (Menu 6-1)
3 Zone 1A Altern.	Menu 2-1-3 Not shown when setpoint toggle is disabled (Menu 3-3)
4 Zone 2A Altern.	Menu 2-1-4 Only shown when two-zone operation is set (Menu 6-1) and setpoint toggle is not disabled (Menu 3-3)

- Menu 2-1-1 Zone 1

COOLING 1 POS: XXXXX		Entry	Default
Setpoint R4.1 XXX °C	Room air temperature setpoint	-45..30	-20 °C
Hystersis R4.1 X K	Room air temperature hysteresis setpoint	1..8	2 K
HT. Cir. Setp. XXX °C	Heating circuit setpoint, only shown when single-zone operation is set (Menu 6-1)	--, -45..30	-20 °C
HT. Cir. Hyst. X K	Heating circuit hysteresis setpoint, only shown when single-zone operation is set (Menu 6-1)	1..8	2 K

- Menu 2-1-2 Zone 2

COOLING 2 POS: XXXXX		Entry	Default
Setpoint R4.3 XXX °C	Room air temperature setpoint	-45..30	-20 °C
Hystersis R4.3 X K	Room air temperature hysteresis setpoint	1..8	2 K

- Menu 2-1-3 Zone 1A Altern.

COOLING 1A POS: XXXXX		Entry	Default
Setpoint R4.1 XXX °C	Room air temperature setpoint	-45..30	-24 °C
Hystersis R4.1 X K	Room air temperature hysteresis setpoint	1..8	2 K
HT. Cir. Setp. XXX °C	Heating circuit setpoint, only shown when single-zone operation is set (Menu 6-1)	--, -45..30	-24 °C
HT. Cir. Hyst. X K	Heating circuit hysteresis setpoint, only shown when single-zone operation is set (Menu 6-1)	1..8	1 K

- Menu 2-1-4 Zone 2A Altern.

COOLING 2A POS: XXXXX		Entry	Default
Setpoint R4.3 XXX °C	Room air temperature setpoint	-45..30	-24 °C
Hystersis R4.3 X K	Room air temperature hysteresis setpoint	1..8	2 K

- Menu 2-2 Defrost

DEFROST POS: XXXXX	
1 Zone 1	Menu 2-2-1
2 Zone 2	Menu 2-2-2 Only shown when two-zone operation is set (Menu 6-1)
3 Zone 1A Altern.	Menu 2-2-3 Not shown when setpoint toggle is disabled (Menu 3-3)
4 Zone 2A Altern.	Menu 2-2-4 Only shown when two-zone operation is set (Menu 6-1) and setpoint toggle is not disabled (Menu 3-3)

- Menu 2-2-1 Zone 1

DEFROST 1 POS: XXXXX		Entry	Default
Counting Rate	Setpoint counting rate	0..15	0
Defrost Counter	Setpoint defrost counter	-	1
Def. End. Tmp. XX °C	Defrost termination temperature setpoint	--, 0..30	10 °C
Wait Time xx m	Waiting time setpoint between cooling and defrosting	0 .. 15	3 m
Drip Time x m	Waiting time (drain time) setpoint between defrosting and cooling	0 .. 15	5 m
2.Defrost Level xx °C	Setpoint 2nd defrost stage	--, -20..30	- °C
M/S Degiv.Fct. XXX	Configuration of the defrost via CAN bus function. For details see chapter Master-Slave-Modus - Abtau-Synchronisation über CAN-Bus .	OFF, MASTR, SLAVE	OFF
M/S CAN Adr. XXX	Selection of the controller (1..99) participating in the defrost via CAN bus which is the master. "--", if this controller is itself master(Parameter <i>M/S Degiv.Fct.</i> = MASTR)	---, 1..99	-
DS-Function XXX	Configuration of the defrost sequence function (DS). For details see chapter Folgeabtauung (FA) über CAN-Bus .	OFF, MASTR, SLAVE	OFF
DS-Group XXX	Selection of which group a defrost sequence of this controller (1..99) belongs to.	---, 1..99	-
DS-Master XXX	Selection of which controller (1..99) participating in the defrost sequence is the master. "--", if this controller is itself the master(Parameter <i>DS-Function</i> = MASTR)	---, 1..99	-
DS-Wait time XXXm	Wait time for the defrost sequence	0..127	1 min

- Menu 2-2-2 Zone 2

DEFROST 2 POS: XXXXX		Entry	Default
Counting Rate	Setpoint counting rate	0..15	0
Defrost Counter	Setpoint defrost counter	-	1
Def. End. Tmp. XX °C	Defrost termination temperature setpoint	--, 0..30	10 °C
Wait Time xx m	Waiting time setpoint between cooling and defrosting	0 .. 15	3 m
Drip Time x m	Waiting time (drain time) setpoint between defrosting and cooling	0 .. 15	5 m

- Menu 2-2-3 Zone 1A Altern.

DEFROST 1A POS: XXXXX		Entry	Default
Counting Rate	Setpoint counting rate	0..15	0
Defrost Counter	Setpoint defrost counter	-	1
Def. End. Tmp. XX °C	Defrost termination temperature setpoint	--, 0..30	10 °C
Wait Time xx m	Waiting time setpoint between cooling and defrosting	0 .. 15	3 m
Drip Time x m	Waiting time (drain time) setpoint between defrosting and cooling	0 .. 15	5 m
2.Defrost Level xx °C	Setpoint 2nd defrost stage	--, -20..30	- °C

- Menu 2-2-4 Zone 2A Altern.

DEFROST 2A POS: XXXXX		Entry	Default
Counting Rate	Setpoint counting rate	0..15	0
Defrost Counter	Setpoint defrost counter	-	1
Def. End. Tmp. XX °C	Defrost termination temperature setpoint	--, 0..30	10 °C
Wait Time xx m	Waiting time setpoint between cooling and defrosting	0 .. 15	3 m
Drip Time x m	Waiting time (drain time) setpoint between defrosting and cooling	0 .. 15	5 m

- Menu 2-3 Fan

FANS POS: XXXXX	
1 Zone 1	Move to menu 2-3-1
2 Zone 2	Move to menu 2-3-2 Only shown when two-zone operation is set (Menu 6-1)
3 Zone 1A Altern.	Move to menu 2-3-3 Not shown when setpoint toggle is disabled (Menu 3-3)
4 Zone 2A Altern.	Move to menu 2-3-4 Only shown when two-zone operation is set (Menu 6-1) and setpoint toggle is not disabled (Menu 3-3)

- Menu 2-3-1 Zone 1

FANS 1 POS: XXXXX		Entry	Default
Fan Delay	Setpoint fan delay	---, -20...20	0 °C

- Menu 2-3-2 Zone 2

FANS 2 POS: XXXXX		Entry	Default
Fan Delay	Setpoint fan delay	---, -20...20	0 °C

- Menu 2-3-1 Zone 1A Altern.

FANS 1A POS: XXXXX		Entry	Default
Fan Delay	Setpoint fan delay	---, -20...20	0 °C

- Menu 2-3-1 Zone 2A Altern.

FANS 2A POS: XXXXX		Entry	Default
Fan Delay	Setpoint fan delay	---, -20...20	0 °C

- Menu 2-4 Alarm

ALARM POS: XXXXX	
1 Zone 1	Menu 2-4-1
2 Zone 2	Menu 2-4-2 Only shown when two-zone operation is set (Menu 6-1)
3 Zone 1A Altern.	Menu 2-4-3 Not shown when setpoint toggle is disabled (Menu 3-3)
4 Zone 2A Altern.	Menu 2-4-4 Only shown when two-zone operation is set (Menu 6-1) and setpoint toggle is not disabled (Menu 3-3)

- Menu 2-4-1 Zone 1

ALARM 1 POS: XXXXX		Entry	Default
High Temp Setp XX °C	High temperature setpoint at which <i>High Temperature</i> alarm is generated	-30..30	-12 °C
Low Temp Setp. XX K	Low temperature setpoint (difference below temperature control setpoint) at which <i>Low Temperature</i> alarm is generated	--, 0..6	2 K

- Menu 2-4-2 Zone 2

ALARM 2 POS: XXXXX		Entry	Default
High Temp Setp XX °C	High temperature setpoint at which <i>High Temperature</i> alarm is generated	-30..30	-12 °C
Low Temp Setp. XX K	Low temperature setpoint (difference below temperature control setpoint) at which <i>Low Temperature</i> alarm is generated	--, 0..6	2 K

- Menu 2-4-3 Zone 1A Altern.

ALARM 1A POS: XXXXX		Entry	Default
High Temp Setp XX °C	High temperature setpoint at which <i>High Temperature</i> alarm is generated	-30..30	-14 °C
Low Temp Setp. XX K	Low temperature setpoint (difference below temperature control setpoint) at which <i>Low Temperature</i> alarm is generated	--, 0..6	2 K

- Menu 2-4-4 Zone 2A Altern.

ALARM 2A POS: XXXXX		Entry	Default
High Temp Setp XX °C	High temperature setpoint at which <i>High Temperature</i> alarm is generated	-30..30	-14 °C
Low Temp Setp. XX K	Low temperature setpoint (difference below temperature control setpoint) at which <i>Low Temperature</i> alarm is generated	--, 0..6	2 K

- Menu 2-5 Frame Heater

FRAME HTR POS: XXXXX	
1 Mode altern.	Move to menu 2-5-1
2 Setpoint frm htr	Move to menu 2-5-2
3 Mode altern.	Move to menu 2-5-3 Not shown when setpoint toggle is disabled (Menu 3-3)
4 Setpoint altern.	Move to menu 2-5-4 Not shown when setpoint toggle is disabled (Menu 3-3)

- Menu 2-5-1 Mode altern.

Select between values. Checkmark shows current setting.

MODE POS: XXXXX		Entry	Default
fixed run time ✓	Fixed frame heater on time	↵	✓
enthalpy-ctrl rtm	Enthalpy control by ambient air temperature and humidity	↵	

- Menu 2-5-2 Setpoint frame heater

SETPOINTS POS: XXXXX		Entry	Default
Mod: xxxxxxxxxxxxx	Displays set frame heater mode (Menu 2-5-1)		Fixed on time
Run Time XXX %	Fixed on time, Only shown when mode set to Fixed On Time (Menu 2-5-1)	--, 0..100	100 %
emerg.run time XXX %	On time in failure of ambient air humidity or temperature signal (via CAN bus) Only shown when mode set to Enthalpy Control (Menu 2-5-1)	--, 0..100	100 %
enthalp. offs. XXX %	Offset to on time with activated enthalpy control (via CAN bus) Only shown when mode set to Enthalpy Control (Menu 2-5-1)	-50..50	0 %
Invert Output xxx	Inversion of the function of the frame heater output (terminal 91/92)	↑, ↓, (ON/OFF)	ON

- Menu 2-5-3 Mode aln.

Select between values. Checkmark shows current setting.

MODE ALT POS: XXXXX		Entry	Default
fixed run time ✓	Fixed frame heater on time	↵	✓
enthalpy-ctrl rtm	Enthalpy control by ambient air temperature and humidity	↵	

- Menu 2-5-4 Setpoint altern.

SOLLW. UM POS: XXXXX		Entry	Default
Mod: xxxxxxxxxxxxx	Displays set frame heater mode (Menu 2-5-3)		Fixed on time
Run Time XXX %	Fixed on time, Only shown when mode set to Fixed On Time (Menu 2-5-3)	--, 0..100	100 %
emerg.run time XXX %	On time in failure of ambient air humidity or temperature signal (via CAN bus) Only shown when mode set to Enthalpy Control (Menu 2-5-3)	--, 0..100	100 %

Eckelmann

SOLLW. UM POS: XXXXX		Entry	Default
enthalp. offs. XXX %	Offset to on time with activated enthalpy control (via CAN bus) Only shown when mode set to Enthalpy Control (Menu 2-5-3)	-50..50	0 %

9.8.4 Menu 3 Clock UR 141 TK

CLOCK POS: XXXXX	
1 Current Time	Move to menu 3-1
2 Defrost timer	Move to menu 3-2
3 Toggle Setpoints	Move to menu 3-3

- Menu 3-1 Current Time

 Time is defined by time master (system centre / store computer / operator terminal) when CAN bus is connected. Any entry made will then be overwritten by the defined value.

CLOCK POS: XXXXX		Entry	Default
Date: XX dd.mm.yy	Display and enter current weekday, date	dd.mm.yy	
Time: hh.mm	Display and enter current time	hh.mm	
Daylight Saving X	Display and enter automatic daylight saving change (Y/N)	↑, ↓, (Y/N)	J

- Menu 3-2 Defrost timer

DERF. TIMER POS: XXXXX		Entry	Default
Defrost timer XXX	Defrost initiation via input D11/12 (EXT) or internal (INT)	↑, ↓, (EXT, INT)	EXT
Safe Defr Time XXX m	Safe defrost time for maximum allowed duration of defrosting (used only for internal defrosting)	0..180	150 min
Manual Defrost XXX	Status (OFF/ON) for supplementary manual defrosting *) shown only when parameter defrost timer = INT	↑, ↓, (ON/OFF)	OFF
Def.Tim.Z2	Separate defrost timer for zone 2	Menu 3-2-a	
Defr. 1 xxxxx hh:mm	Defrost start time with internal defrosting; Weekday, time; shown only when parameter defrost timer = INT	↑, ↓, (Mo-Su etc.) or numbers (hh:mm)	Mo-Su07:00
Defr. 2 xxxxx hh:mm	Defrost start time with internal defrosting; Weekday, time; shown only when parameter defrost timer = INT	↑, ↓, (Mo-Su etc.) or numbers (hh:mm)	Mo-Su19:00
...			
Defr. 14 xxxxx hh:mm			

 *) Parameter automatically set to ON for safe defrost time at first start.

• Menu 3-2-a Def.Tim.Z2

DEFR.TIMER POS: XXXXX		Entry	Default
Defrost Timer XXX	Setting for how temperature zone 2 should defrost: <ul style="list-style-type: none"> • With Z1 Together with zone 1 • INT Internally • EXT Externally – the defrost of both temperature zones is started simultaneously via the external signal 	↑, ↓, (ViaZ1, ViaZ1,EXT,INT)	ViatZ1
Safe Defr Time XXX m	Safe defrost time, i.e. max. allowed duration of defrosting (internal defrost only)	0..120	60 min
Manual Defrost XXX	Status (ON/OFF) of auxiliary manual defrost *)	↑, ↓, (ON/OFF)	OFF
Defr. 1 xxxxx hh:mm	Defrost start time for internal defrost; weekday, time of day; shown only when parameter <i>defrost timer</i> = INT	↑, ↓, (Mo-Su) or numbers (hh:mm)	Mo-Su 01:00
...			
Defr. 14 xxxxx hh:mm			

• Menu 3-3 Toggle Setpoints

TOGGLE POS: XXXXX		Entry	Default
Status XXX	Setpoint toggle status (OFF/ON) of alternative set of setpoints (setpoint toggle)		
Toggle Setp. XXX	Setpoint toggle via <ul style="list-style-type: none"> • EXT digital input D21/22 • INT internal timer • CAN bus- „--“ deactivated Note: Care should be taken that the corresponding digital input D21/D22 is set to SOLLW.UMSCH (menu 6-2-4)	↑, ↓, (EXT, INT, CAN, --)	EXT
Alt ON: DD-DD hh:mm	Start time for toggle to alternative set of setpoints Weekday from - to XXXXX, time hh:mm Only shown when internal setpoint toggle is activated (Menu 3-3)	↑, ↓, (Mo-Su etc.) or numbers (hh:mm)	Mo-Su 21:00
Alt OFF: DD-DD hh:mm	End time for toggle to alternative set of setpoints Weekday from - to XXXXX, time hh:mm Only shown when internal setpoint toggle is activated (Menu 3-3)	↑, ↓, (Mo-Su etc.) or numbers (hh:mm)	Mo-Su 05:00
Alt ON: DD-DD hh:mm	Start time for toggle to alternative set of setpoints Weekday from - to XXXXX, time hh:mm Only shown when internal setpoint toggle is activated (Menu 3-3)	↑, ↓, (Mo-Su etc.) or numbers (hh:mm)	Su 05:00
Alt OFF: DD-DD hh:mm	End time for toggle to alternative set of setpoints Weekday from - to XXXXX, time hh:mm Only shown when internal setpoint toggle is activated (Menu 3-3)	↑, ↓, (Mo-Su etc.) or numbers (hh:mm)	Su 21:00

Eckelmann

TOGGLE POS: XXXXX		Entry	Default
...	A total of 7 different ON and OFF toggle times can be defined. A toggle time will only be obeyed when a <u>matched pair</u> of on and off times is set as a parameter.		

9.8.5 Menu 4 Messages UR 141 TK

MESSAGES POS: XXXXX	
1 View	Move to menu 4-1: Show Message Log
2 Acknowledge	Messages in message log are cancelled. <i>"Alarms Cancelled!"</i> shown in display: Press ESC to go back.
3 Delete	Move to menu 4-2: Delete Message Log (with prompt)

- Menu 4-1 View Messages

MESSAGES POS: XXXXX	
Error Message 1:	Fault 1 message text
dd.mm.yy hh:mm ON	Start of Fault 1
dd.mm.yy hh:mm OFF	End of Fault 1 (only when Fault 1 terminated)
...	
Error Message n:	Fault n message text
dd.mm.yy hh:mm ON	Start of Fault n
dd.mm.yy hh:mm OFF	End of Fault n (only when Fault n terminated)

- Menu 4-2 Acknowledge Messages
This displays the *"Alarms Cancelled!"* message.
- Menu 4-3 Delete Messages

MESSAGES POS: XXXXX		Entry
Delete! Are you sure? No: ESC YES: ↵	Safety prompt for deleting messages Press ESC to go back after cancelling messages.	↵, ESC

9.8.6 Menu 5 Archive UR 141 TK

ARCHIVE POS: XXXXX	
dd.mm.yy hh:mm	Time of archiving Record 1
Zone 1: abcdef x °C	Status and temperature of Zone 1, see Note
Zone 2: abcdef x °C	Status and temperature of Zone 2, see Note Only shown when two-zone operation is set (Menu 6-1)
...	
dd.mm.yy hh:mm	Time of archiving Record n
Zone 1: abcdef x °C	Status and temperature of Zone 1, see Note
Zone 2: abcdef x °C	Status and temperature of Zone 2, see Note Only shown when two-zone operation is set (Menu 6-1)

 *) Status abcdef covers following states of refrigeration point. The entry at this position is - when a state is not active. Example Zone 1: abcdef x °C

	Single-zone operation resp. Operator interface BT 300	Two-zone operation
a	O = Operation	O = Operation
b	R = Refrigeration / Cooling	R = Refrigeration / Cooling
c	R = Refrigeration/ Cooling	D = Defrost
d	D = Defrost	G = Gate / Door (cold-room controller only)
e	G = Gate / Door (cold-room controller only)	A = Alarm
f	A = Alarm	

9.8.7 Menu 6 Configuration UR 141 TK

CONFIGURAT POS: XXXXX	
1 Refriger. Point	Move to menu 6-1
2 Controller	Move to menu 6-2
3 Cooling	Move to menu 6-3
4 Language	Move to menu 6-4
5 Alarm priorities	Move to menu 6-5
6 Em.Powersupply	Move to menu 6-6
7 Enhanced	Move to menu 6-7

- Menu 6-1 Refriger. Point

REFR. PT. POS: XXXXX		Entry	Default
Refr. Pt. Name:	Text only		
xxxxxxxxxxxxxxxx	Free text entry describing refrigeration point (see note)		Kühlstellenregler
Item ID: XXXXX	Free text entry displayed in screens after ITEM ID (see note)		UA400
Priority: XX	Alarm priority in failure of refrigeration point or when global controller priority is set (Menu 6-5)	↑, ↓, or numbers (0..99)	1
Refr. Sys. No.: XX	No. of pack controller allocated to case/cold-room controller	↑, ↓, or numbers (–, 1..9)	1
Refr. Sys. Type XXX	Associated compressor pack. Parameter only required when linked to a VS 3010 BS having several zones. If a different type of pack controller is used, set this parameter blank (–)	↑, ↓, or numbers (–, Z1, Z2)	Z2
Temp. Zones X	Number of temperature zones Single-zone operation Two-zone operation	↑, ↓, or numbers (1, 2)	2
No. Sensors XX	Number of temperature sensors connected. After entering ↵ sensor scan is performed to redetermine the number of sensorium of sensors	↵	

 The priority must be assigned between 0..2 by older versions of the store computer (<V5.0), see chapter [Alarms and Messages of UA 400](#).

- ① A meaningful name that describes the refrigeration point in more detail should be entered, e.g. Cheese Counter 2 and CC2. Entry is made in the screens on system centre, store computer or operator terminal. Direct entry cannot be made in the controller screens displayed on the operator terminal. Entry cannot be made either on operator interface BT 300.

- Menu 6-2 Controller

CONTROLLER POS: XXXXX	
1 Type and Version	Move to menu 6-2-1
2 Temp. Display	Move to menu 6-2-2
3 Alarm Delay	Move to menu 6-2-3
4 230V Inputs	Move to menu 6-2-4
5 Sensor Type	Move to menu 6-2-5

- Menu 6-2-1 Type and Version

VERSION POS: XXXXX		Entry	Default
Ctrlr. Type XXXXXXXX	Controller type set by DIP Switch S3	–	UR141TK
Software Ver.: XXXX	Software version of case/cold-room controller	–	x.yy
Serial No.: XXXXXXX	Device No. of case/cold-room controller	–	
Master/Sl. Mode XXX	Synchronized defrosting in master-slave mode (ON/OFF)	–	

- Menu 6-2-2 Temp. Display

DISPLAY POS: XXXXX		Entry	Default
Offset XX K	Offset for temperature display	-10..10	0K
Alarm symbol X	Show alarm symbol on BT 30 Temperature Display	↑, ↓, (Y/N)	N

- Menu 6-2-3 Alarm Delay

ALARMDELAY POS: XXXXX		Entry	Default
Sensor Fault XX m	Sensor break alarm delay	0..30	15 min
High/Low Temp. XX m	High/low temperature alarm delay	0..150	90 min
Door Open XX m	Cold-room door open alarm delay	0 .. 60	60 m
No Defrost XX h	No defrost alarm delay	--, 2..168	30 h
Selfholding X	NO: Automatic reset of non- transient alarms. YES: Alarms must be reset manually.	↑ , ↓ , (Y/N)	N

- Menu 6-2-4 230V Inputs

 Only trained personnel should be allowed to change inputs, as changes may affect other functions.

230V INPUT POS: XXXXX		Entry	Default
Entry1: XXXXXXXXXXXX	Function of digital input 1 D11/D12	1)	DEFR.TIMER
Entry2: XXXXXXXXXXXX	Function of digital input 2 D21/D22	2)	DOOR CONTACT
Entry3: XXXXXXXXXXXX	Function of digital input 3 D31/D32	3)	DOOR CONTACT
Entry4: XXXXXXXXXXXX	Function of digital input 4 D41/D42	4)	Extern.Alarm
XXXXXXXXXXXXXXXXXXXX	Freely configurable alarm text for digital input 4,the default text is "CO2-Alarm"	Text	CO2-ALARM
Inv. D1 XXX	Inverting of digital input 1	↑ , ↓ , (ON/OFF)	OFF
Inv. D2 XXX	Inverting of digital input 2		OFF
Inv. D3 XXX	Inverting of digital input 3		OFF
Inv. D4 XXX	Inverting of digital input 4		OFF

Possible settings for the digital inputs:

1. DEFR.TIMER Defrost timer*
 MANUAL OFF. Manual shutoff both zones
 MANUAL OFF. Z1 Manual shutoff only Z1
 MANUAL OFF. Z2 Manual shutoff only Z2
 TOGGLE SETP. Toggle setpoint
2. DOOR CONTACT Door contact 2 *
 MANUAL OFF Manual shutoff both zones
 MANUAL OFF. Z1 Manual shutoff only Z1
 MANUAL OFF. Z2 Manual shutoff only Z2
 TOGGLE SETP Toggle setpoint
3. DOOR CONTACT Door contact 1 *
 MANUAL OFF Manual shutoff both zones *
 MANUAL OFF. Z1 Manual shutoff only Z1
 MANUAL OFF. Z2 Manual shutoff only Z2

Eckelmann

- 4. EXT ALARM External Alarm *
 - MANUAL OFF Manual shutoff both zones
 - MANUAL OFF. Z1 Manual shutoff only Z1
 - MANUAL OFF. Z2 Manual shutoff only Z2
 - TOGGLE SETP Toggle setpoint

*Factory setting

Eckelmann

- Menu 6-2-5 Sensor Type

Select between values. Checkmark shows current setting.

SENSORS POS: XXXXX		Entry	Default
L243 ✓	Temperature range -50..50°C	↩	✓
K277	Temperature range -50..50°C	↩	
5K3A1	Temperature range 0..100°C	↩	

- Menu 6-3 Cooling

COOLING POS: XXXXX		Entry	Default
Min. On Time XX K	Minimum cooling ON time	0..15	2 m
Min. Off Time XX m	Minimum cooling OFF time	0..15	2 m
Fan forerun xx m	Delay after fans start	0..100	3 m
Emergency Op. xx m	In failure of required sensors, the solenoid valve is actuated to adjust to the set opening in %.	0..100	100%

- Menu 6-4 Language

LANGUAGE POS: XXXXX	Entry	Default
Deutsch D ✓	↩	✓
English GB	↩	
Francais F	↩	
Espagnol E	↩	
Finnish FIN	↩	
Türkce TR	↩	
Cesky CZ	↩	

- Menu 6-5 Alarm priorities

ALARMPRIOS POS: XXXXX		Entry	Default
Prio.Refrig. Pt. X	Global alarm priority by refrigeration point priority (Menu 6-1) (Y)	↑, ↓, (Y,N)	N
Priority: XX	Show refrigeration point priority (Menu 6-1) Only shown when refrigeration point priority set to Y.		
<i>Following parameters are only shown when refrigeration point priority is set to N. Meaning of usable entries for alarm priority: -=Event ignored 0=Message (entered only in message log) 1=Priority 1 alarm..99=Priority 99 alarm</i>			
Low Temp.	Temperature below lower alarm limit Priority applies to following alarms: Low Temp. Zone1, Low Temp. Zone2	-, 0..99	2
High Temp.	Temperature above upper alarm limit Priority applies to following alarms: High Temp. Zone1, High Temp. Zone2	-, 0..99	1
Sensor Fault	Temperature sensor failure	-, 0..99	2
Door Open	Cold-room door open alarm delay	-, 0..99	2
No Defrost	No defrost within alarm delay interval Priority applies to following alarm: No defrost	-, 0..99	0
Timer-Term.Defr.	Defrosting terminated by safe defrost time	-, 0..99	0
Power Failure	Start following power failure	-, 0..99	0
First Start	Controller start up (basic settings loaded!)	-, 0..99	2
Manual Shutoff	Manual switch Input D31/D32 set OFF	-, 0..99	0
Hardware Fault	Internal hardware fault Priority applies to following alarms: EEPROM Fault, RTC Fault, Flash Fault	-, 0..99	1
Setpoint Change	Message generated on changing setpoint	0..99	0
Refrig.Pt.Dis.	Cooling by pack controller via CAN bus interrupted	-, 0..99	0
Battery Voltage	Battery low	-, 0..99	0

- Menu 6-6 Em.Powersupply (Emergency Power supply)

EM.POW.SUP POS: XXXXX		Entry	Default
Cool.funct.OFF xxx	Functionality of the cooling switched off during emergency power supply? (Y/N)	↑ , ↓ , (Y/N)	N
Defr.funct.OFF xxx	Functionality of the defrosting switched off during emergency power supply? (Y/N)	↑ , ↓ , (Y/N)	N
Fan funct. OFF xxx	Functionality of the fan switched off during emergency power supply? (Y/N)	↑ , ↓ , (Y/N)	N
Frame fct.OFF xxx	Functionality of the frame heater off during emergency power supply? (Y/N)	↑ , ↓ , (Y/N)	N
Light fct. OFF xxx	Functionality of the light during emergency power supply? (Y/N)	↑ , ↓ , (Y/N)	N

- Menu 6-7 Enhanced

ENHANCED POS: XXXXX	
1 SDS TEV	Move to menu 6-7-1
2 Service Mode	Move to menu 6-7-2

- Menu 6-7-1 SDS TEV

SDS TEV POS: XXXXX		Entry	Default
SDS TEV xx m	Principle participation of the controller in the suction pressure shift. (function COPT+). Note: This is transmitted via a CAN bus telegram and intervenes in the regulation!	↑, ↓, (ON/OFF)	OFF
Inact.a.Def xx m	Delay time following completion of the defrost before the controller actively intervenes in the shift.	0..40	30 min,
Dely_HystON xxxxm	Delay time for the reduction request with active cooling and overshoot of the hysteresis.	0..10	2.5 min
HiTmpZ1 dwn xxm	Delay time before the elapse of the high temperature alarm delay in zone 1, before the reduction is requested.	0..15	5 min.
HiTmpZ2 dwn xxm	Delay time before the elapse of the high temperature alarm delay in zone 2, before the reduction is requested.	0..15	5 min.
ToOvHystZ1 xxK	Tolerance limit above the setpoint plus hysteresis in zone 1. Influences when it is switched from stop to reduce.	0..20	2 K
ToOvHystZ2 xxK	Tolerance limit above the setpoint plus hysteresis in zone 2. Influences when it is switched from stop to reduce.	0..20	2 K
SwchSupRet xxx	Switching from supply air to return air and the reverse with temperature alarm delay time.	↑, ↓, (ON/OFF)	OFF
Dely_Switch xxxm	Switching from supply to return air: determines when it is switched within the delay time for the high temperature alarm.	0..15	5 min.
Add.Values xxx	Creation of additional (additive) "Debug" actual value archives in the system centre / store computer. Warning: This can force a reorganisation of the actual value archives – for this reason only use when required!	↑, ↓, (ON/OFF)	OFF
Incl_UpLim xxxK	Upper limit of the neutral zone for determining the incline.	0..5	0.3 K
Incl_LwLim xxxK	Lower limit of the neutral zone for determining the incline.	0..5	0.2 K

- Menu 6-7-2 Service Mode

SERVICIE MOD POS: XXXXX		Entry	Default
Relay 1 x	Relay 1 (terminal 15/16/18) switch on or off (1 or 0)	0 / 1	0
Relay 2 x	Relay 2 (terminal 25/26/28) switch on or off (1 or 0)	0 / 1	0
Relay 3 x	Relay 3 (terminal 35/36/38) switch on or off (1 or 0)	0 / 1	0
Relay 4 x	Relay 4 (terminal 43/44) switch on or off (1 or 0)	0 / 1	0
Relay 5 x	Relay 5 (terminal 53/54) switch on or off (1 or 0)	0 / 1	0
Relay 6 x	Relay 6 (terminal 64/65) switch on or off (1 or 0)	0 / 1	0
Relay 7 x	Relay 7 (terminal 73/74) switch on or off (1 or 0)	0 / 1	0
24V Out 1 x	Transistor output 1 (terminal 81/82) switch on or off (24 VDC / 50 mA)	0 / 1	0
24V Out 2 x	Transistor output 2 (terminal 91/92) switch on or off (24 VDC / 50 mA)	0 / 1	0
ANA OUT 1 xxxV	Analog output 1 (terminal 29/30) Default 0..10 VDC	0..10	0.0V
ANA OUT 2 xxxV	Analog output 2 (terminal 31/32) Default 0..10 VDC	0..10	0.0V
ANA IN 1 xxmA	Power analog input 1 (terminal 11/12) 4..20 mA	4..20	mA
ANA IN 2 xxmA	Power analog input 2 (terminal 11/14) 4..20 mA	4..20	mA
InputD 1 xxx	Status digital input 1 ON = 230 V AC voltage connected OFF = no voltage present	ON/OFF	-
InputD 2 xxx	Status digital input 2 ON = 230 V AC voltage connected OFF = no voltage present	ON/OFF	-
InputD 3 xxx	Status digital input 3 ON = 230 V AC voltage connected OFF = no voltage present	ON/OFF	-
InputD 4 xxx	Status digital input 4 ON = 230 V AC voltage connected OFF = no voltage present	ON/OFF	-

10 Decommissioning and disposal

10.1 Decommissioning / Demounting

The dismantling of the equipment may only be performed by authorised and trained personnel.

DANGER

Warning of dangerous electrical voltage! Danger of electric shock!

During dismantling, the same safety instructions and hazard warnings must be observed as for installation, putting into service and maintenance, see chapter Safety instructions.

ATTENTION

For dismantlement, follow the steps for assembly in reverse order, see chapter Installation and Putting into Service.

10.2 Disposal

Our scope of delivery is a component that is intended exclusively for further processing. As a consequence of this fact, Eckelmann AG does not take any measures for the taking back or municipal recycling of this product as it is not supplied directly to the free market.

Potential negative impact on people and the environment due to non-environmentally friendly disposal!

- In accordance with the contractual agreement, the customer has a duty to dispose of electrical and electronic waste in compliance with the statutory regulations based on the Directive 2012/19/EU – WEEE2 on waste electrical and electronic equipment.
- Ensure the environmentally friendly disposal of the packaging, the product and its components at the end of their service life. Observe the applicable national regulations and laws.

ATTENTION



The device may contain a lithium battery (for details, see chapter Electrical Data) that must be disposed of separately! Please inform yourself about the local regulations for the separate disposal of electrical and electronic products and batteries.

11 Alarms and Messages of UA 400

The following table lists all fault reports that may be generated and their possible cause. Each fault is assigned a priority that can be set in the Alarm Priorities screen.

No.	Message	Cause	Correction
Hardware faults			
4	EEPROM Fault	Component for saving configuration defective or configuration data in EEPROM implausible.	Save parameters in LDSWin software, perform first start if necessary and load parameters from LDSWin. Contact Service Organization if fault recurs
6	Flash Fault	Flash memory module defective.	Please contact Service Organization -Replace device
8	RTC Fault	Real-time clock defective.	Please contact Service Organization -Replace device
10	Battery Voltage	Real-time clock and RAM backup battery dead	Replace battery (see chapter UA 400 installation and start-up)
50	First Start	Controller performed first start (basic settings loaded).	-
51	Power Failure	Controller performed restart after power outage.	-
120	Low Temp. Zone 1	Temperature below lower limit on monitored control sensors of Zone 1.	Check parameter setting, sensors, system
121	Low Temp. Zone 2	Temperature below lower limit on monitored control sensors of Zone 2.	Check parameter setting, sensors, system
122	High Temp. Zone 1	Temperature above upper limit on monitored control sensors of Zone 1.	Check parameter setting, sensors, system
123	High Temp. Zone 2	Temperature above upper limit on monitored control sensors of Zone 2.	Check parameter setting, sensors, system
124	Door open Door open Z1/Z2	Cold-room controllers only: Cold-room door i.e. Cold-room Z1 or Z2 open beyond alarm interval 1	Close door, check door switch or connecting cable
125	No Defrost	Defrosting not performed within alarm interval.- A defrost sequence via CAN bus was not correctly configured- A master/slave defrost via CAN bus was not correctly configured	Check parameterization: Check the internal/ external defrost timer, defrost times, alarm delay time, configuration of the master/slave defrost via CAN bus (see chapter Master-Slave-Modus - Abtau-Synchronisation über CAN-Bus), check the configuration of the defrost sequence via CAN bus (see chapter Folgeabtauung (FA) über CAN-Bus).
126	Timer-Term. Defrost	Defrosting terminated by safe defrost time. Heater defective, contactor defective, evaporator iced.	Check parameter settings: Defrost termination temperature too low, check evaporator for icing, check location of defrost sensor, set defrost termination temperature to "--"
		 Defrosting is always terminated by safe defrost time on controllers working with off-cycle defrosting. Alarm may be displayed at intervals on these controllers without an actual fault occurring.	

No.	Message	Cause	Correction
127	Manual Shutoff	<i>Manual Shutdown</i> digital input actuated.	-
128	Sensor Fault Fx	Sensor fault! Sensor disconnected, short-circuited or corrupted by external interference. Temperature on sensor outside set measuring range. Monitoring is performed on required or optional sensors recognized by controller as result of sensor scan.	Check connecting cable, Check cable shielding or Replace sensor(s) concerned: F1..F9 = Terminal /Z12..Z91/92F10 = Terminal Z01/Z02
	Sensor Fault A1, A2	The message "Sensor fault A1/A2" appears when in menu 6-2-6 the parameter "AIN1" and "AIN2" of the analogue inputs are set to "Active=Yes" but no sensor is recognized. Note: A1/A2 = Analog input AIN1/AIN2	Check connecting cable, Check cable shielding ,Replace sensor(s) concerned or set the parameter „AIN1" resp. AIN2" in the menu 6-2-6 to „AIN1/2 activ=no"
189	Refrig. Pt. Disabl.	Refrigeration point enabling disabled.	-
240	Setpoint Change	Setpoint changed.	-

11.1 Alarm signalling and monitoring

11.1.1 Cold-room door open alarm

Controller type UR 141 NK (NT), UR 141 TK (LT)

Alarm is generated if the cold-room door remains open beyond a definable time. If the alarm delay is set to 0 minutes then the cooler and the evaporator fan are not switched off and the alarm is immediately dispatched. In the event of a permanently open door, an alarm is activated and the controller returns to cooling following the elapse of the adjustable alarm delay time.

11.1.2 High or low temperature alarm

High or low temperature is alarmed when temperature rises or falls to the alarm setpoint on a supply air or return air sensors and the set delay has expired.

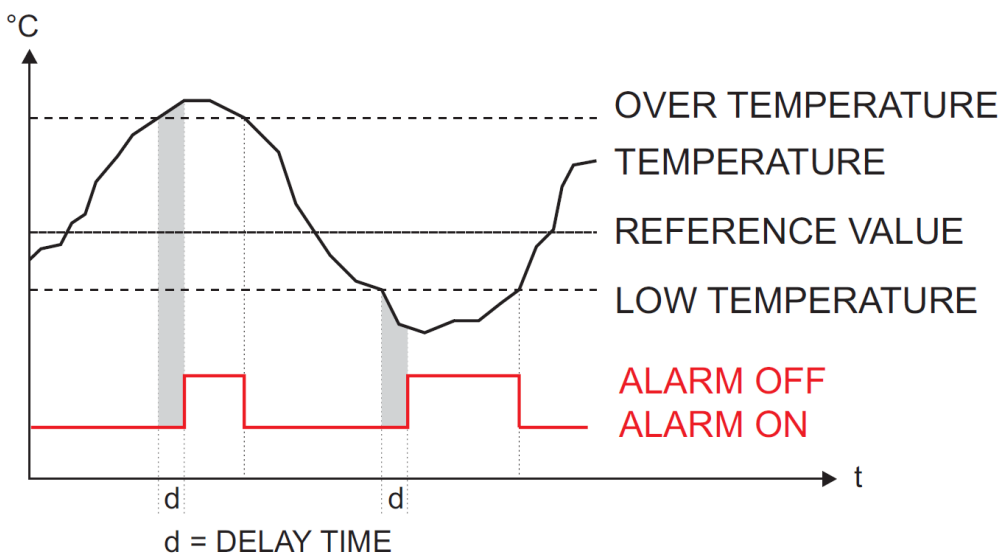

Standard settings

The high temperature setpoint is entered in °C, whereas the low temperature setpoint is entered as a difference to the cooling setpoint in K. High and low temperature setpoints can be set separately for each temperature zone. The time delay applies to all.

With controller types UA 111/UA 111 D and UA 141, the return air sensors are monitored only for the low-temperature setpoint. With other controller types, no differentiation of sensor type is made as regards alarm. During a forced cooling the delay time for the low temperature alarm is reset in order to prevent a false alarm during the forced cooling operation.

i This alarm is inactive during defrosting. Any delay that may have started is reset at the commencement of defrosting and restarts from the beginning on completion of defrosting. The parameter "*Temp.alarm*" must be set to the value "--" (factory setting).

Advanced settings

Controller types UA 121, UA 131, and UA 131 DD

For the supply air sensor an optional warning value can be used. In this case a separate alarm message is generated if the supply air exceeds this warning value.

In general, the case controller employs a common high temperature warning value for the supply and return air sensors. In special cases it may be desirable to configure a separate warning value for the supply air sensor (menu 2-4-1.. 2-4-4).

As soon as the parameter "*Temp.alarm.*" is set to a value other than "--", the controller employs the separate warning values for supply and return air.

11.1.3 Alarm in the event of the absence of a defrost

The Alarm "No Defrost" is generated if the alarm does not take place within an adjustable time. No alarm is generated if defrosting is suppressed due to high temperature or by demand defrosting.

⚠ So as to avoid false alarm, the time delay for **No Defrost** alarm should not be set too short (**No Defrost** parameter in Menu 6-2-3). When the maximum interval between two set defrost times is 48 hours, for example (Menu 3-2), the **No Defrost** alarm time delay must be set at least one hour longer, i.e. to 49 hours.

Master/slave defrost / defrost sequence via CAN bus

If the defrost is not conducted then the alarm message „No Defrost" is generated by both the master and slave controller. The generation of this message is coupled to the alarm delay time and thus is automatically sent by all affected controllers if no defrost takes place.

i **For defrost sequence via CAN bus only:** In master/slave operation the alarm "No Defrost" can also mean that a slave no longer has any contact to the master. If a slave fails to receive a signal from its defrost master for a period longer than 60 minutes, then this message is generated.

11.1.4 Sensor break alarm

Alarm is generated after the set delay if the controller detects breakage or short circuit on a sensor (menu 6-2-3).

i Sensor break alarm is always generated for sensors vital to control functions. In the case of optional sensors, alarm is only generated when the sensors have not been removed from monitoring by sensor scan (Menu 6-1).

11.1.5 Suppression of sensor break alarm during defrosting

While defrosting is in progress, temperature sensors and particularly the evaporator sensors may become heated to a temperature above the limits of the case/cold-room controller's temperature detection range. Sensor break alarm is accordingly suppressed for the duration of defrosting so as to avoid signalling of false alarms. The following conditions apply:

- Sensor break alarm effective prior to defrosting is NOT suppressed.
- Sensor break alarm takes place with the set delay during any drain time that may be defined.
- Sensor break occurring during defrosting and persisting beyond termination of defrosting is alarmed when the set delay expires.
- Sensor break alarm suppression is effective with all types of defrost (internal, external, discharge gas, manual and master/slave defrosting). With internal and manual defrosting, sensor break alarm is suppressed for the complete safe defrost time regardless of defrosting terminating before that.

i In the most unfavourable instance, sensor break alarm is merely postponed. The longest possible delay would be $(2 * T_{\text{Sensor break delay}}) + T_{\text{Defrost}}$

- If the delay time for the sensor failure alarm is set to zero minutes there is no alarm suppression and the alarm is generated immediately following detection of the sensor failure. This setting is not recommended for the continuous operation of the controller!

- In contrast to the general procedure for treating a sensor failure, the following applies in the case of discharge gas defrosting: This procedure serves to prevent false alarms when, during discharge gas defrosting, the defrost sensor becomes so warm that it exceeds the temperature range of the controller.

11.1.6 Hardware fault alarm

Alarm is generated without delay if the controller detects hardware problems. Malfunction of the following components is detected:

- Temperature measurement
- General fault
- Loss of setpoint (memory problems)
- Time/date
- First start

Priority for transmitting the alarm is governed by the controller priority and type of alarm.

11.1.7 Individual allocation of priorities

It is possible in the case controller to allocate an individual priority for most alarms (parameter *Kühlstellenregler prio* set to NO, menu 6-5). This enables the targeted addressing of alarm destinations and the adjustment of alarm signalling to individual requirements.

The priority on the controller side is used if the parameter *Kühlstellenregler prio* is set to YES (menu 6-5). It is also always used for the alarm signalling in the event of failure of the control by the system centre / store computer.

The value range for the priorities is extended to 0..99 so that up to 100 alarm destinations can be differentiated. This priority range is divided into 10 alarm groups (decades).

- The 1 and 2 priorities (1,11,21,...91 and 2,12,22,...92) are reserved for high priority alarms that affect the alarm relays "PRIO1" and "PRIO2" as well as the LEDs "PRIO1" and "PRIO2" on the front of the store computer.
- The highest priority number in each group (9,19,29,...99) is reserved for low priority alarms which should only generate local alarm signalling (e.g. open cold room door).
- All other priority numbers are intended for low priority alarms.
- The lowest priority number in each group (0,10,20,..90) is reserved for messages that are only recorded in the message list.
- If the priority is set to "-", no message is generated.

This division into alarm groups (decades) facilitates maintenance group oriented alarm management.

 The alarm priorities --, 0..2 correspond to the remote alarm messaging concept of older store computer versions with firmware versions <5.0. If priorities from 3..99 are configured in the controller, the store computer must be updated to a firmware version of 5.0 or higher. Further information is provided in the store computer operating manual.

The respective alarms (exception: refrigeration point priority and setpoint adjustment) can also be set to the value "-" and thus be completely removed from the alarm signalling.

If the parameter *Kühlstellen-Priorität* is sent to the value NO (menu 6-5), the allocation of individual priorities is enabled. For the setting YES, the alarm priorities are allocated according to the previous schema with the value of the refrigeration point priority. This simplifies the configuration for standard applications.

The following assignments arise from the allocation of the global priority:

Alarms with global priority	Alarms with the priority 0
Low Temperature High Temperature Sensor Fault Cold room door open (only for the room controllers) No defrost (all except UR 141 TK) First start EEPROM Fault RTC Fault Flash Fault	No defrost (only UR 141 TK) Time defrost termination Power failure Manual shutdown Setpoint change Refrigeration point disabled Battery voltage External alarm (CO2 alarm)

Special feature: for the UR 141 TK, the priority for the *No Defrost* alarm signalling is set to zero, while this value corresponds to the global controller priority for all other controller types.



- If an alarm with a controller priority > 0 is pending and this priority is set to 0 before the alarm has been marked as gone, the controller has no possibility to reset the alarm in the store computer. Therefore, it is recommended after any change of alarm priorities to the value 0 to restart the controller or ensure that the adjusted alarms are not active at the time of the adjustment.
- If the case controller is used with store computers without extended priority allocation, the priorities may only be allocated between 0..2 or "-" (see store computer operating manual for priority allocation). In the case of incorrect parametrisation, the alarm signalling behaviour of the store computer is undefined (particularly with regard to the assignment of priorities to alarm destinations). This also applies for the refrigeration point priority.

11.1.8 Alarm routes

A detected alarm state is transmitted by the controller by the following routes:

- At the alarm relay (floating changeover contact 15/16/18)
- A local BT 300 x Operator Interface connected to DISPLAY interface
- Via the CAN bus interface on a system centre / store computer / operator terminal in the E*LDS-System.

11.1.9 Termination of alarm

The condition for termination of an alarm can be selected from two basic principles:

- Automatic reset of all alarms after correcting the cause
- Manual reset of all alarms after correcting the cause

The manual reset of the alarm / alarm state can be performed

- By switching off the controller, regardless of whether the alarm is still active
- On a local BT 300 x Operator Interface connected to the display port
- Via the CAN bus interface using a system centre / store computer / operator terminal in the E*LDS-System.

11.1.10 Restart

During a restart old alarms are marked with a send time stamp.

11.2 Messages

States outside normal operating conditions but not constituting an alarm state are reported via the interfaces and entered in the message log.

Examples of such messages:

- Electric power failure
- Change of setpoint
- Manual shutdown
- Defrosting terminated by safe defrost time

11.2.1 Transient alarms and messages

Transient alarms are one-time event alarms and are not time stamped for send time. As a result, transient alarms are not deleted automatically after the event and must be cancelled manually. This applies regardless of the setting made for Self holding (Menu 6-2-3).

The following are transient alarms

- Time-terminated defrosting
- Change of setpoint
- Electric power failure
- First start

11.2.2 Message log

A maximum of 25 alarms and messages with receive and send date and time are entered in the message log.

 The alarms and messages are stored in a ring buffer. When the ring buffer is full, the next new entry deletes the oldest entry.

12 Specifications of UA 400

12.1 Electrical data

⚠ Warning about dangerous electrical voltage! Danger to life - Danger of electric shock!
Overvoltage category III (test voltage 4.0 kV) / contamination degree 2: All connections of the device provided for operation with 230 V AC supply voltage **must** be wired with the same phase conductor. 400 V AC between neighbouring connection terminals is **not** permitted!
Overvoltage category II (test voltage 2.5 kV) / contamination degree 2 or overvoltage category II (test voltage 2.5 kV) / contamination degree 1: Different phase conductors may be used. 400 V AC between neighbouring connection terminals is permitted!

	UA 400 CC / UA 400 AC
Electrical data	
Operating voltage	230 V AC (+/- 10%), 50/60 Hz (+/- 3 Hz)
Rated power	11 VA
Leakage current via PE	max 1 mA
Rated surge voltage	2.5 kV for overvoltage category II 4.0 kV for overvoltage category III
Relay outputs	4 x normally open contact, 250 V AC, floating output, min 10 mA Load type: ohmic: max. 6 A, inductive: max. 3 A, cos phi = 0.4 3 x changeover contact, 250 V AC, floating output, min 10 mA Load type: ohmic: max. 6 A, inductive: max. 3 A, cos phi = 0.4
Transistor outputs	2 x 24 V DC pull down switching transistor with internal current limitation to 50 mA for lighting control and frame heater
Digital inputs	4 x 230 V AC, floating output
Real-time clock	Only UA 400 AC: With power reserve and lithium cell (for details, see ""Transport and storage") Accuracy: typical 12 minutes per year at 25 °C
Field bus interface	CAN bus, floating output
Data ports	DISPLAY: BT 300 x operator interface and up to four BT 30Ci320 (TTY) temperature displays: Communication with the PC software for reading out the operating data
USB port	For firmware update (in future it will be possible to connect a notebook (PC) to this interface for the direct parameterisation via LDSWin)
Monitoring function	Watchdog
Environmental conditions	

	UA 400 CC / UA 400 AC
Transport and storage	<p>The controller contains a 3 V lithium cell (design type CRC 2450 N, shelf life 10 years) with capacity of 540 mAh and lithium content of 0.16 g.</p> <p>The battery complies with the UN3090 requirements for lithium metal cells. No special markings or measures for transport and storage are required up to a lithium amount of 2.5 kg per package (total amount for pallets or containers).</p>
Temperature range	<p>Transport: -20 °C ... +80 °C Operation: 0 °C ... +50 °C</p>
Temperature change	<p>Transport: max. 20 K/h Operation: max. 10 K/h</p>
Relative humidity (non-condensing)	<p>Transport: 5% ... 85% Operation: 5% ... 85%</p>
Shock according to DIN EN 60068-2-27	Transport and operation: 30 g
Vibration 10 Hz ... 150 Hz according to DIN EN 60068-2-6	Transport and operation: 2 g
Atmospheric pressure	<p>Transport: 660 hPa ... 1060 hPa Operation: 860 hPa ... 1060 hPa</p>
Weight	approx. 680 g
Standards and Directives	
Protection rating	IP20 (EN 60529)
Automatic operating mode	Mode of operation type 1.K
Software class A	<ul style="list-style-type: none"> • EN 60730-1 Appendix A
CE conformity according to	<ul style="list-style-type: none"> • Low Voltage Directive 2014/35/EU; Official Journal of the EU L96, 29/03/2014, pages 357-374 • EMC Directive 2014/30/EU; Official Journal of the EU L96, 29/03/2014, pages 79-106 • RoHS Directive 2011/65/EU; Official Journal of the EU L174, 01/07/2011, pages 88-110

12.2 Mechanical Data

DIN rail mounting

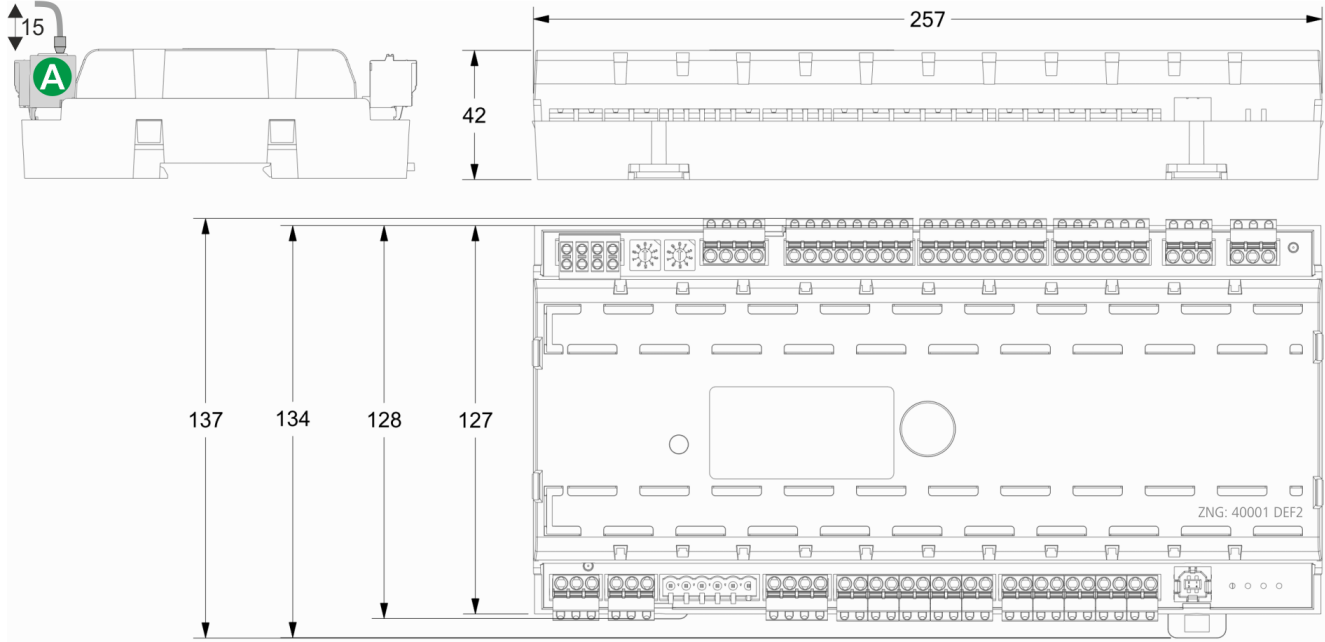

(A): Connector set with cable

All dimensions in mm

12.3 Mechanical data of the temperature sensor L243 / 5K3A1

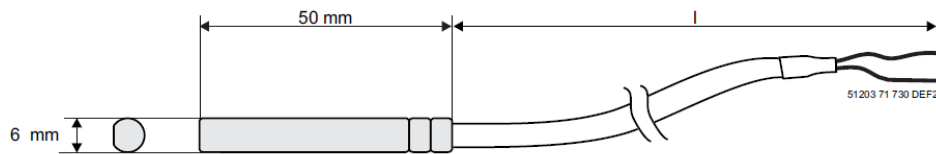

All dimensions in mm.

Sensor type / length/ order number:

- **L243**
 - l = 3,0 m (KGLZTEMP56)
 - l = 5,8 m (KGLZTEMP58)
- **5K3A1**
 - l = 8,5 m (KGLZ5K3A1 / KGLZ5K3A1S)

For detailed information of the temperature sensors see [data sheet](#).

13 Order numbers and accessories of UA 400 / UA 410

13.1 Case controller

Type	Description	Part number
UA 400 AC	For 2 thermostatic expansion valves, for DIN rail mounting, with CAN bus, real-time clock, internal archive	KGLUA4N011
UA 400 CC	For 2 thermostatic expansion valves, for DIN rail mounting, with CAN bus	KGLUA4N012

13.2 Components

Component	Description	Order number
Temperature sensors (NTC)	L243 (Standard) 3,0 m, 5,8 m 5K3A1 8,5 m L243 (K243) Block sensor (old design)	KGLZTEMP56 KGLZTEMP58 KGLZ5K3A1 KGLZL243
Pressure transmitter	Low pressure transmitter 0..10 bar 4..20 mA High pressure transmitter 1..26 bar 4..20 mA 1..61 bar 4..20 mA 1..161 bar 4..20 mA	KGLZDRUCK3 KGLZDRUCK4 KGLZDRUCK5 KGLZDRUCK6
Humidity and temperature sensor	Combined humidity sensor (4..20 mA) and temperature sensor (Pt1000 4-wire) for wall mounting	KGLZPTHYGR
BT 300 x Operator Interface and Temperature display	BT 300 M Operator Interface handheld operating terminal for customer service with 2,8 m connecting cable BT 300 S Operator Interface for panel mounting BT 300 C For cabinets and serve over counters	LIBDTUA052 LIBT300S51 LIBDTUA051
BT 30 Temperature display	Temperature display with 7 m connecting cable (RJ45) RJ45 splitter for the connection of up to four BT 30 on an case controller	BT30LC0002 KGLVERT001
USB-A-B cable	USB-A-B cable with ferrite core 1. For direct parameterisation of the case contr. via LDSWin or 2. For carrying out a firmware update of the case controller or 3. The parameterisation of system components via CAN bus using LDSWin	PCZKABUSB1
Connector set	Connector set for UA 400 E CC	STVSETUAB3